



Top Flite Models Champaign, IL
 Ph: (217) 398-8970, Ext. 5
 Fax: (217) 398-7721
 airsupport@top-flite.com

P-40 WARHAWK

WARRANTY

Top Flite® Model Manufacturing Co. guarantees this kit to be free from defects in both material and workmanship at the date of purchase. This warranty does not cover any component parts damaged by use or modification. **In no case shall Top Flite's liability exceed the original cost of the purchased kit.** Further, Top Flite reserves the right to change or modify this warranty without notice.

In that Top Flite has no control over the final assembly or material used for final assembly, no liability shall be assumed nor accepted for any damage resulting from the use by the user of the final user-assembled product. By the act of using the user-assembled product, the user accepts all resulting liability.

If the buyer is not prepared to accept the liability associated with the use of this product, the buyer is advised to return this kit immediately in new and unused condition to the place of purchase.

To make a warranty claim send the defective part or item to Hobby Services at this address:

Hobby Services
 3002 N. Apollo Dr. Suite 1
 Champaign IL 61822 USA

Include a letter stating your name, return shipping address, as much contact information as possible (daytime telephone number, fax number, e-mail address), a detailed description of the problem and a photocopy of the purchase receipt. Upon receipt of the package the problem will be evaluated as quickly as possible.

SPECIFICATIONS

| | |
|----------------------|---|
| Wingspan: | 86 in [2185mm] |
| Wing Area: | 1262 sq in [81.4 dm ²] |
| Weight: | 23– 24 lb [10430– 10880 g] |
| Wing Loading: | 42– 44 oz/sq ft [128–134 g/dm ²] |
| Length: | 72 in [1830mm] |
| Radio: | 5-7 channel minimum |
| Engine: | 2.6–3.3 cu in [43–55cc] two-stroke gasoline engine |

READ THROUGH THIS MANUAL BEFORE STARTING CONSTRUCTION. IT CONTAINS IMPORTANT INSTRUCTIONS AND WARNINGS CONCERNING THE ASSEMBLY AND USE OF THIS MODEL.

TABLE OF CONTENTS

| | | | |
|--|----|--|----|
| INTRODUCTION | 2 | Mount The Retractable Tail Gear | 18 |
| Academy Of Model Aeronautics. | 2 | Install The Elevator & Rudder Servos | 20 |
| IMAA | 2 | INSTALL THE ENGINE, MUFFLER, RADIO | |
| Scale Competition | 3 | AND REMAINING SERVOS | 22 |
| SAFETY PRECAUTIONS | 3 | INSTALL THE COWL | 30 |
| DECISIONS YOU MUST MAKE | 3 | INSTALL THE COCKPIT, PILOT | |
| Radio Equipment | 3 | AND CANOPY | 31 |
| Engine Recommendations | 4 | APPLY THE DECALS | 32 |
| OPTIONAL ROBERT RETRACTABLE | | GET THE MODEL READY TO FLY | 34 |
| LANDING GEAR | 4 | Check The Control Directions | 34 |
| ADDITIONAL ITEMS REQUIRED | 4 | Set The Control Throws | 34 |
| Required Hardware & Accessories | 4 | Check the Retract Operation | 35 |
| Optional Supplies & Tools | 4 | Balance The Model (C.G.) | 35 |
| IMPORTANT BUILDING NOTES | 4 | Balance The Model Laterally | 35 |
| COMMON ABBREVIATIONS | 5 | PREFLIGHT | 36 |
| KIT INSPECTION | 5 | Identify Your Model | 36 |
| KIT CONTENTS | 5 | Charge The Batteries | 36 |
| ORDERING REPLACEMENT PARTS | 6 | Balance Propellers | 36 |
| PREPARATIONS | 6 | Ground Check And Range Check | 36 |
| ASSEMBLE THE WING | 6 | ENGINE SAFETY PRECAUTIONS | 36 |
| INSTALL THE FIXED WIRE LANDING GEAR | 9 | AMA SAFETY CODE (excerpts) | 37 |
| INSTALL THE RETRACTABLE | | General | 37 |
| LANDING GEAR | 12 | Radio Control | 37 |
| MOUNT THE WING NACELLES | 14 | CHECK LIST | 37 |
| JOIN THE WING HALVES | 15 | FLYING | 38 |
| ASSEMBLE THE FUSELAGE | 17 | Fuel Mixture Adjustments | 38 |
| Install The Stabilizer | 17 | Takeoff | 38 |
| Install The Tail Gear Assembly | 18 | Flight | 38 |
| Mount The Fixed Tail Gear | 18 | Landing | 39 |



INTRODUCTION

Top Flite is very proud to bring you the P-40 Warhawk ARF. The Curtiss P-40 Warhawk became one of the most important fighters of World War II, and was flown in every combat theatre. This legendary fighter is best known for the Flying Tiger markings of the American Fighter Group (AVG). This is a great flying model that you will enjoy and will turn heads at the flying field. We have made a realistic airplane that has no bad flight characteristics. We believe you will be thrilled with the final product.

For the latest technical updates or manual corrections to the Giant Scale P-40 ARF visit the Top Flite web site at www.top-flite.com. Open the "Airplanes" link, then select the Giant Scale P-40 ARF. If there is new technical information or changes to this model a "tech notice" box will appear in the upper left corner of the page.

ACADEMY OF MODEL AERONAUTICS

If you are not already a member of the AMA, please join! The AMA is the governing body of model aviation and membership provides liability insurance coverage, protects modelers' rights and interests and is required to fly at most R/C sites.

Academy of Model Aeronautics
5151 East Memorial Drive
Muncie, IN 47302-9252



Ph. (800) 435-9262
Fax (765) 741-0057

Or via the Internet at:
<http://www.modelaircraft.org>

IMPORTANT!!! Two of the most important things you can do to preserve the radio controlled aircraft hobby are to avoid flying near full-scale aircraft and avoid flying near or over groups of people.

IMAA

The Top Flite Giant Scale P-40 ARF is an excellent sport-scale model and is eligible to fly in IMAA events. The IMAA (International Miniature Aircraft Association) is an organization that promotes non-competitive flying of giant-scale models. If you plan to attend an IMAA

event, obtain a copy of the **IMAA Safety Code** by contacting the IMAA at the address or telephone number below, or by logging onto their web site at: www.fly-ima.org/ima/sanction.html.

IMAA
205 S. Hilldale Road
Salina, KS 67401
(913) 823-5569



SCALE COMPETITION

Though the Top Flite P-40 is an ARF and may not have the same level of detail as an "all-out" scratch-built competition model, it is a scale model nonetheless and is therefore eligible to compete in the *Fun Scale* class in AMA competition (we receive many favorable reports of Top Flite ARFs in scale competition!). In Fun Scale, the "builder of the model" rule does not apply. To receive the five points for scale documentation, the only proof required that a full size aircraft of this type in this paint/markings scheme did exist is a single sheet such as a kit box cover from a plastic model, a photo, or a profile painting, etc. If the photo is in black and white other written documentation of color must be provided. Contact the AMA for a rule book with full details.

If you would like photos of the full-size P-40 for scale documentation, or if you would like to study the photos to add more scale details, photo packs are available from:

Bob's Aircraft Documentation
3114 Yukon Ave Ph: (714) 979-8058
Costa Mesa, CA 92626 Fax: (714) 979-7279
e-mail: www.bobsairdoc.com

PROTECT YOUR MODEL, YOURSELF & OTHERS... FOLLOW THESE IMPORTANT SAFETY PRECAUTIONS

1. Your P-40 should not be considered a toy, but rather a sophisticated, working model that functions very much like a full-size airplane. Because of its performance

capabilities, the P-40, if not assembled and operated correctly, could possibly cause injury to yourself or spectators and damage to property.

2. You must assemble the model **according to the instructions**. Do not alter or modify the model, as doing so may result in an unsafe or unflyable model. In a few cases the instructions may differ slightly from the photos. In those instances the written instructions should be considered as correct.

3. You must take time to **build straight, true and strong**.

4. You must use an R/C radio system that is in good condition, a correctly sized engine, and other components as specified in this instruction manual. All components must be correctly installed so that the model operates correctly on the ground and in the air. You must check the operation of the model and all components before **every** flight.

5. If you are not an experienced pilot or have not flown this type of model before, we recommend that you get the assistance of an experienced pilot in your R/C club for your first flights. If you're not a member of a club, your local hobby shop has information about clubs in your area whose membership includes experienced pilots.

6. While this kit has been flight tested to exceed normal use, if the plane will be used for extremely high stress flying, such as racing, or if an engine larger than one in the recommended range is used, the modeler is responsible for taking steps to reinforce the high stress points and/or substituting hardware more suitable for the increased stress.

7. **WARNING:** The cowl, belly pan and other misc parts included in this kit are made of fiberglass, the fibers of which may cause eye, skin and respiratory tract irritation. Never blow into a part to remove fiberglass dust, as the dust will blow back into your eyes. Always wear safety goggles, a particle mask and rubber gloves when grinding, drilling and sanding fiberglass parts. Vacuum the parts and the work area thoroughly after working with fiberglass parts.

We, as the kit manufacturer, provide you with a top quality, thoroughly tested kit and instructions, but ultimately the quality and flyability of your finished model depends on how you build it; therefore, we cannot in any way guarantee the performance of your completed model, and no representations are expressed or implied as to the performance or safety of your completed model.

Remember: Take your time and follow the instructions to end up with a well-built model that is straight and true.

DECISIONS YOU MUST MAKE

This is a partial list of items required to finish the P-40 that may require planning or decision making before starting to build. Order numbers are provided in parentheses.

RADIO EQUIPMENT

The P-40 can be flown with a minimum of a five channel radio if you are using the fixed landing gear and "Y" harnesses on the servos. If you install the retractable landing gear you will need a minimum of a six channel radio with a "Y" harness on the servos. For our installation we used a twelve channel radio. One channel each was used for the throttle, choke, right elevator, left elevator, rudder, right aileron, left aileron, right flap, left flap and retracts.

Recommended servos: All control surfaces require the use of a high quality servo of at least 85 oz.-in. of torque. A servo of 40 oz.-in. of torque can be used for the throttle, choke and air control valve.

- Control surfaces – Futaba® 9402 (FUTM0102)
- Throttle, choke and air valve Futaba 3003 (FUTM0031)
- 2 - 24" [310mm] Pro™ Series Heavy Duty Servo Extensions (HCAM2721) for the ailerons.
- 5 - 12" [305mm] Pro Series Heavy Duty Servo Extensions (HCAM2711); two for the flaps, two for the elevator halves and one for the rudder.

Depending on your choice of receiver and the number of channels you will be using you may have to use "Y" harnesses on the aileron, flaps and elevator. (FUTM4130)

- 1500 mAh NiCad receiver battery or equivalent (FUTM1285).
- 2 - Heavy duty switch harness (FUTM4385).
- 2 - Ernst Charge Receptacle (ERNM3001).
- 2 - 1" Servo arms
- 1 - 2" Servo arm

(There are a number of options for servo arms. We used the Du-Bro Super Strength Arms. (DUBM6670) This package includes eight servo arms, including the two needed for this model).

ENGINE RECOMMENDATIONS

The recommended engine size range for the P-40 is 43cc to 55cc [2.6 - 3.3 cu in] two-stroke gasoline engine. We used the DLE™ 55 engine for our model. We have provided instructions and hardware for the Fuji-Imvac™ 43 EI (FJIG134) and the DLE 55 (DLEG0055). Other engines can also be used but you may need to make modifications for mounting those engines.

OPTIONAL ROBART RETRACTABLE LANDING GEAR

Robart makes a very realistic, high quality, scale landing gear for the P-40. This landing gear rotates just the same as the full scale airplane providing a very realistic operation. This is a tremendous addition to the airplane. If you choose to use them you will need the following.

- 100 Degree retract large scale (ROBQ1665)
- 157VR Large Air Control Kit (ROBQ2305)
- 169 Pressure Tubing 10' Red/Purple (ROBQ2369)
- #160LWC LH Offset Pneumatic Tail Wheel (ROBQ0225)

ADDITIONAL ITEMS REQUIRED

REQUIRED HARDWARE & ACCESSORIES

This is the list of hardware and accessories required to finish the P-40. Order numbers are provided in parentheses.

- R/C foam rubber (1/4" [6mm] - HCAQ1000, or 1/2" [13mm] - HCAQ1050)
- 3' [900mm] gasoline fuel tubing (GPMQ4135)
- 1 oz. [30g] Thin Pro™ CA (GPMR6002)
- 1 oz. [30g] Medium Pro CA+ (GPMR6008)
- Pro 30-minute epoxy (GPMR6047)
- Pro 6-minute epoxy (GPMR6045)
- Silver solder w/flux (STAR2000)
- Hobbico® Soldering Iron 60 Watt (HCAR0776)
- #1 Hobby knife (HCAR0105)
- #11 blades (5-pack, HCAR0211)
- R/C-56 canopy glue (JOZR5007)
- Epoxy brushes (6, GPMR8060)
- Mixing sticks (50, GPMR8055)
- Mixing cups (GPMR8056)
- Masking tape (TOPR8018)
- Threadlocker thread locking cement (GPMR6060)
- Denatured alcohol (for epoxy clean up)
- Panel Line Pen (TOPQ2510)
- Rotary tool such as Dremel®
- Rotary tool reinforced cut-off wheel (GPMR8200)
- Drill bits: 1/16" [1.6mm], 1/8" [3.2mm], 5/64" [2mm], 3/32" [2.4mm], 7/64" [2.8mm], 3/16" [4.8mm], 5/16" [8mm], 1/4" [6.4mm].
- Du-Bro Fuel Line Barb 1/8" (DUBQ0670)

OPTIONAL SUPPLIES & TOOLS

Here is a list of optional tools mentioned in the manual that will help you build the P-40.

- 21st Century® sealing iron (COVR2700)
- 21st Century® iron cover (COVR2702)
- 2 oz. [57g] spray CA activator (GPMR6035)
- 4 oz. [113g] aerosol CA activator (GPMR634)
- Epoxy brushes (6, GPMR8060)
- Mixing sticks (50, GPMR8055)

- Mixing cups (GPMR8056)
- Denatured alcohol (for epoxy clean up)
- Panel Line Pen (TOPQ2510)
- Rotary tool such as Dremel®
- Rotary tool reinforced cut-off wheel (GPMR8200)

IMPORTANT BUILDING NOTES

- There are three types of screws used in this kit:

Sheet Metal Screws are designated by a number and a length. For example #6 × 3/4" [19mm].

This is a number six screw that is 3/4" [19mm] long.

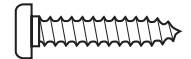

Machine Screws are designated by a number, threads per inch, and a length. For example 4-40 × 3/4" [19mm].

This is a number four screw that is 3/4" [19mm] long with forty threads per inch.

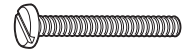

Socket Head Cap Screws (SHCS) are designated by a number, threads per inch, and a length. For example 4-40 × 3/4" [19mm].

This is a 4-40 SHCS that is 3/4" [19mm] long with forty threads per inch



- When you see the term **test fit** in the instructions, it means that you should first position the part on the assembly **without using any glue**, then slightly modify or *custom fit* the part as necessary for the best fit.
- Whenever the term **glue** is written you should rely upon your experience to decide what type of glue to use. When a specific type of adhesive works best for that step, the instructions will make a recommendation.
- Whenever just **epoxy** is specified you may use **either** 30-minute (or 45-minute) epoxy **or** 6-minute epoxy. When 30-minute epoxy is specified it is **highly** recommended that you use only 30-minute (or 45-minute) epoxy, because you will need the working time and/or the additional strength.

- **Photos** and **sketches** are placed **before** the step they refer to. Frequently you can study photos in following steps to get another view of the same parts.
- The Giant Scale P-40 ARF is factory-covered with Top Flite® MonoKote film. Should repairs ever be required, MonoKote can be patched with additional MonoKote purchased separately. MonoKote is packaged in six-foot rolls, but some hobby shops also sell it by the foot. If only a small piece of MonoKote is needed for a minor patch, perhaps a fellow modeler would give you some. MonoKote is applied with a model airplane covering iron, but in an emergency a regular iron could be used. A roll of MonoKote includes full instructions for application. Following are the colors used on this model and order numbers for six foot rolls.

Flat Olive Drab TOPQ0510 Flat Dove Gray TOPQ0511
 Flat Tan TOPQ0516 Missile Red TOPQ0201
 Flat Black TOPQ0508

- The stabilizer and wing incidences and engine thrust angles have been factory-built into this model. However, some technically-minded modelers may wish to check these measurements anyway. To view this information visit the web site at www.top-flite.com and click on "Technical Data." Due to manufacturing tolerances which will have little or no effect on the way your model will fly, please expect slight deviations between your model and the published values.

COMMON ABBREVIATIONS

Stab = Horizontal Stabilizer

Fin = Vertical Stabilizer

LE = Leading Edge

TE = Trailing Edge

" = Inches

mm = Millimeters

SHCS = Socket Head Cap Screw

mAh = Milliamp Hours (refers to the usable capacity of a battery)

To convert inches to millimeters, multiply inches by 25.4 (25.4mm = 1")

KIT INSPECTION

Before starting to build, take an inventory of this kit to make sure it is complete, and inspect the parts to make sure they are of acceptable quality. If any parts are missing or are not of acceptable quality, or if you need assistance with assembly, contact **Product Support**. When reporting defective or missing parts, use the part names exactly as they are written in the Kit Contents list.

Top Flite Product Support

3002 N Apollo Drive, Suite 1
 Champaign, IL 61822

Ph: (217) 398-8970, ext. 5

Fax: (217) 398-7721

E-mail: airsupport@top-flite.com

KIT CONTENTS

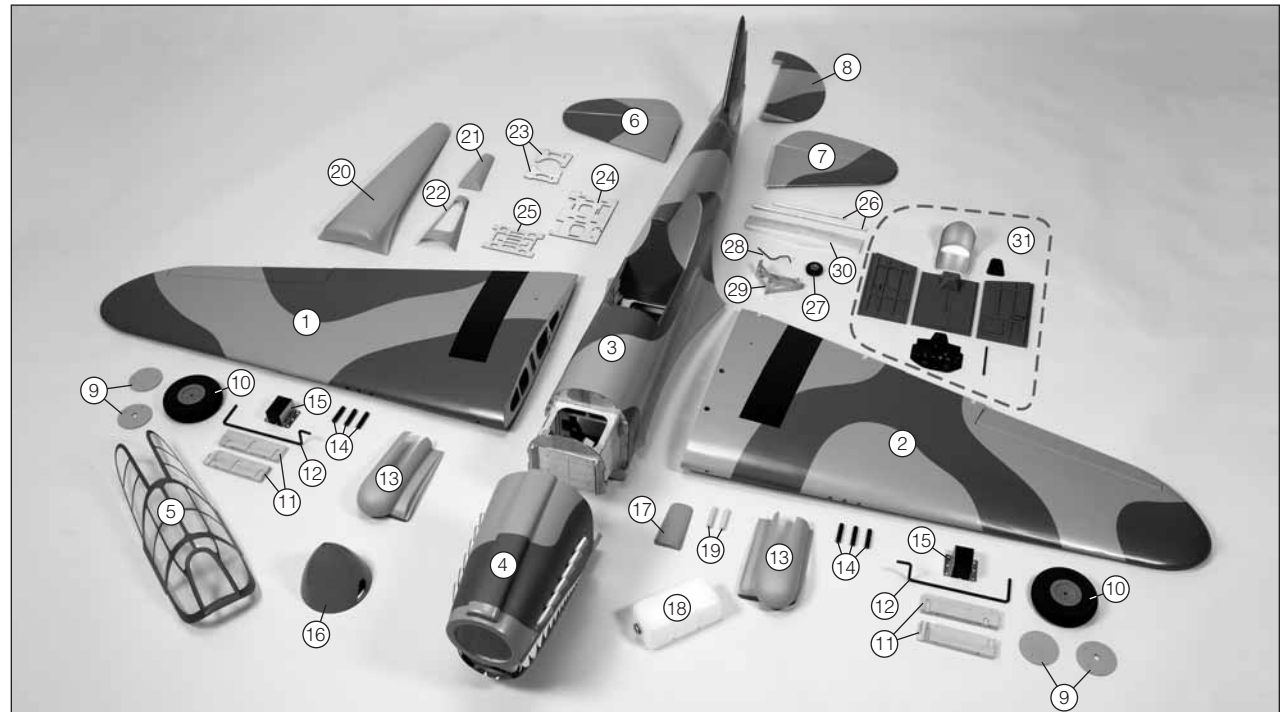

- | | | |
|---------------------------------|------------------------|---------------------------|
| 1. Right Wing w/ Aileron & Flap | 12. Landing Gear Wire | 23. Air Tank Support |
| 2. Left Wing w/ Aileron & Flap | 13. Wheel Nacelles | 24. Servo/Receiver Tray |
| 3. Fuselage | 14. Machine Gun Tubes | 25. Ignition/Battery Tray |
| 4. Cowl | 15. Landing Gear Mount | 26. Stab Tubes (2) |
| 5. Canopy | 16. Spinner | 27. Tail Wheel |
| 6. Right Stabilizer & Elevator | 17. Cowl Extension | 28. Tail Wheel Wire |
| 7. Left Stabilizer & Elevator | 18. Fuel Tank | 29. Tail Wheel Bracket |
| 8. Rudder | 19. Leading Edge Dowel | 30. Wing Joiner |
| 9. Wheel Covers | 20. Belly Pan | 31. Cockpit Components |
| 10. Wheels | 21. Rear Belly Pan | |
| 11. Landing Gear Blocks | 22. Tail Wheel Cover | |

ORDERING REPLACEMENT PARTS

Replacement parts for the Top Flite Giant Scale P-40 ARF are available using the order numbers in the **Replacement Parts List** that follows. The fastest, most economical service can be provided by your hobby dealer or mail-order company.

To locate a hobby dealer, visit the Top Flite web site at www.top-flite.com. Select "Where to Buy" in the menu across the top of the page and follow the instructions provided to locate a U.S., Canadian or International dealer.

Parts may also be ordered directly from Hobby Services by calling (217) 398-0007, or via facsimile at (217) 398-7721, but full retail prices and shipping and handling charges will apply. Illinois and Nevada residents will also be charged sales tax. If ordering via fax, include a Visa® or MasterCard® number and expiration date for payment.

Mail parts orders **Hobby Services**
and payments by 3002 N Apollo Drive, Suite 1
personal check to: Champaign IL 61822

Be certain to specify the order number exactly as listed in the **Replacement Parts List**. Payment by credit card or personal check only; no C.O.D.

If additional assistance is required for any reason contact **Product Support**

by e-mail at productsupport@top-flite.com **or by telephone at** (217) 398-8970

REPLACEMENT PARTS LIST

| Order No. | Description |
|-----------|--------------------------|
| TOPA1795 | Fuselage |
| TOPA1796 | Wing |
| TOPA1797 | Stab and Elevators |
| TOPA1798 | Rudder |
| TOPA1799 | Cowl |
| TOPA1800 | Canopy |
| TOPA1801 | Fixed Landing Gear Wires |
| TOPA1802 | Landing Gear Nacelle Set |
| TOPA1803 | Tail Wheel Bracket |

| | |
|----------|---------------------------|
| TOPA1804 | Spinner |
| TOPA1805 | Decals |
| TOPA1806 | Cockpit Kit |
| TOPA1807 | Belly Pan and Aft Fairing |
| TOPA1808 | Tail Gear Cover |

PREPARATIONS

❑ 1. If you have not done so already, remove the major parts of the kit from the box and inspect for damage. If any parts are damaged or missing, contact Product Support at the address or telephone number listed in the "Kit Inspection" section on page 5.



❑ 2. Use a covering iron with a covering sock on high heat to tighten the covering if necessary. Do this for all of the components of the model. Apply pressure over sheeted areas to **thoroughly** bond the covering to the wood.

ASSEMBLE THE WING

Note: Throughout this instruction manual you will be instructed to use screws to secure different parts. In all cases, whenever a screw is threaded into wood sheeting or wood blocks we recommend that you install the screw and then remove it. Apply a drop of thin CA glue into the hole to harden the threads. After the glue has hardened, re-install the screw. Following this step will insure that you have a solid thread for you screws.

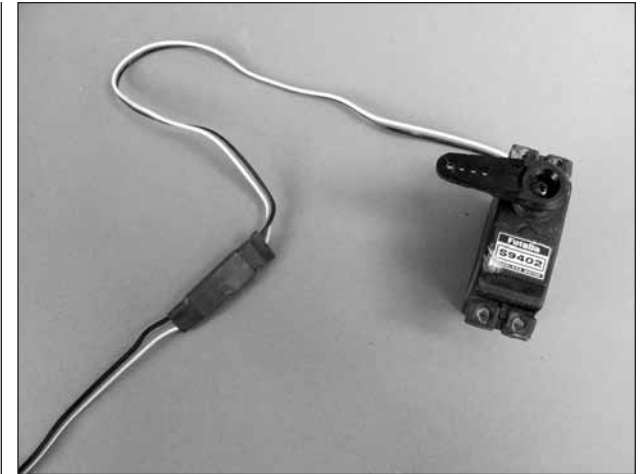

Begin with your right **wing panel** first so your assembly matches the photos in the manual.

❑ ❑ 1. Install a 24" [610mm] servo extension to your aileron servo. Secure it with heat shrink tubing, tape or other method for securing them together.

❑ ❑ 2. Install a 12" [305] servo extension to your flap servo. Secure it with heat shrink tubing, tape or other method for securing them together.

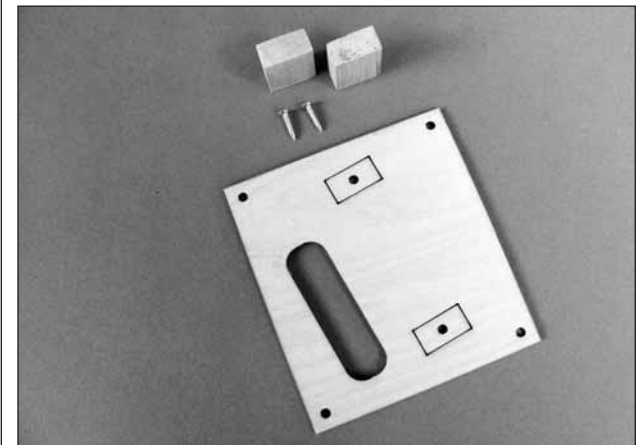

❑ ❑ 3. Remove the tape holding the **servo covers** to the bottom of the wing. Locate two 5/16" x 1/2" x 3/4" [8mm x 13mm x 19mm] hardwood blocks. The markings on the back of the cover are correct for

Futaba servos. Place your particular brand of servo on the cover making sure they fit between the locations for the blocks. Adjust the positioning of the blocks for your brand of servo.

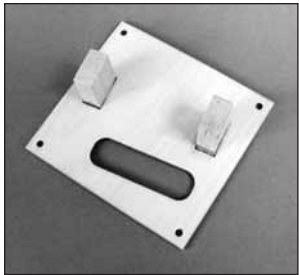

□ □ 4. Glue the blocks to the servo cover. Once the glue has cured, drill a 1/16" [1.6mm] hole through the cover and into the servo mounting blocks. Secure the block to the cover with a #2 × 3/8" [#2 × 9.5mm] wood screw. Do this for both of the servo covers.

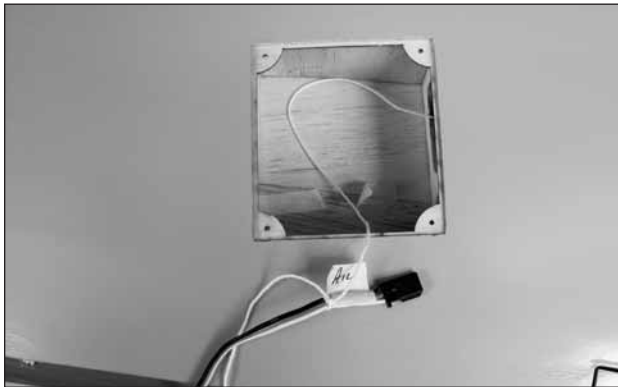

□ □ 5. Inside the aileron and flap servo compartments you will find a string. Tie the string to the servo lead. The other end of the string is taped to the root wing of the rib. Pull the leads through the wing.

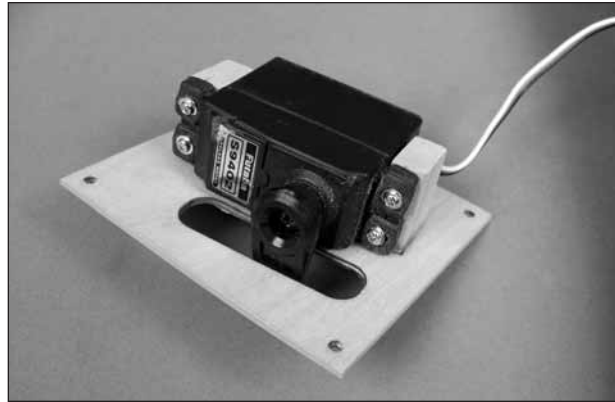

□ □ 6. Install the servo arms onto your servos. The aileron servo will require a 1" [25mm] servo arm to get the required aileron throw. A standard length arm will work for the flap. Place your servo onto the mounting blocks. Drill a 1/16" [1.6mm] hole through the servo mounting tabs into the mounting blocks. Secure the servos to the mounting blocks with the screws that came with your servos.

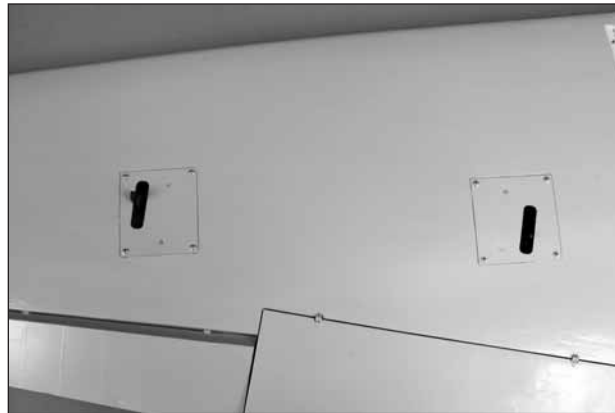

□ □ 7. Install the servo covers to the wing securing them to the wing with four #2 × 3/8" [9.5mm] screws and four #2 flat washers.

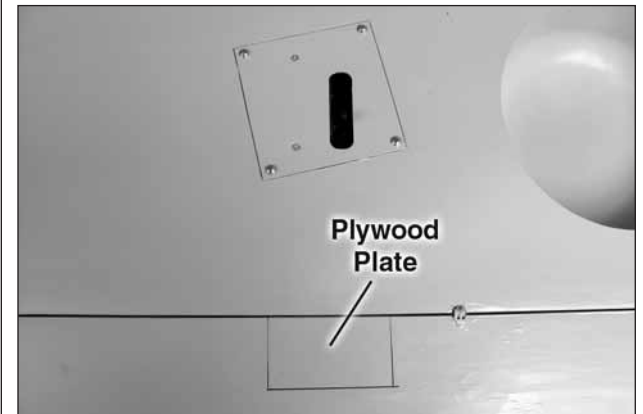
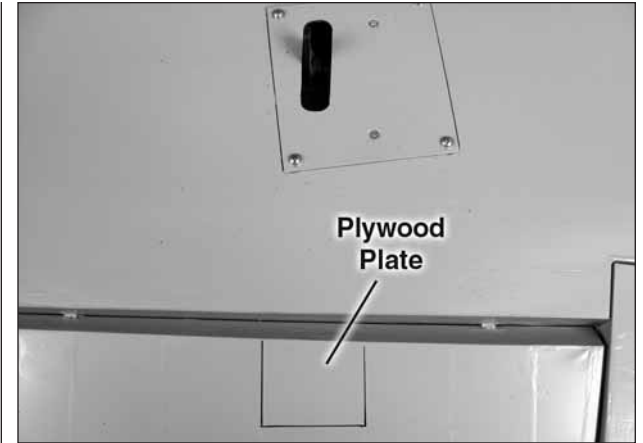

□ □ 8. Located in both the aileron and the flap is a plywood mounting plate. If you look at the control surface at a slight angle you will be able to see the plate through the covering.

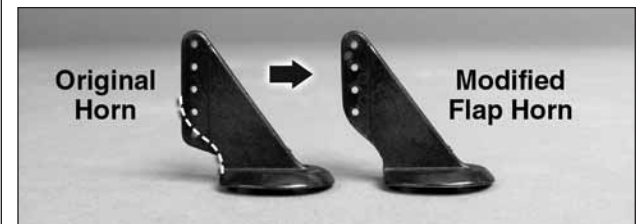

□ □ 9. The flap and aileron will each require a black nylon control horn. The flap control horn needs to be modified. Cut a control horn as shown. A high-speed motor tool works well for this.

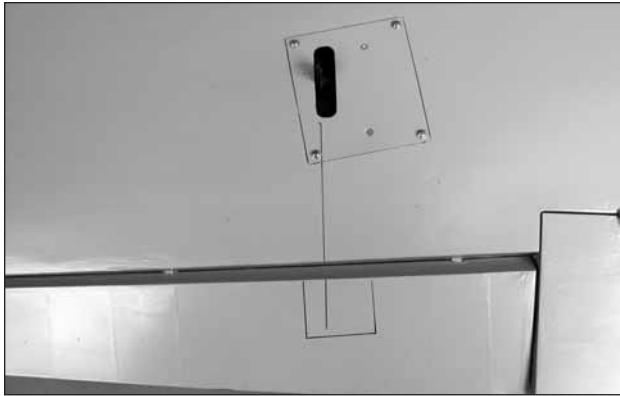

□ □ 10. Place a black nylon control horn onto the plywood mounting plate in the aileron in line with the servo arm. Drill a 3/32" [2.4mm] hole through each of the holes in the control horn. Drill only through the plywood plate. **Do not drill through the top of the control surface.** Mount the horn with four #4 × 3/8" screws.

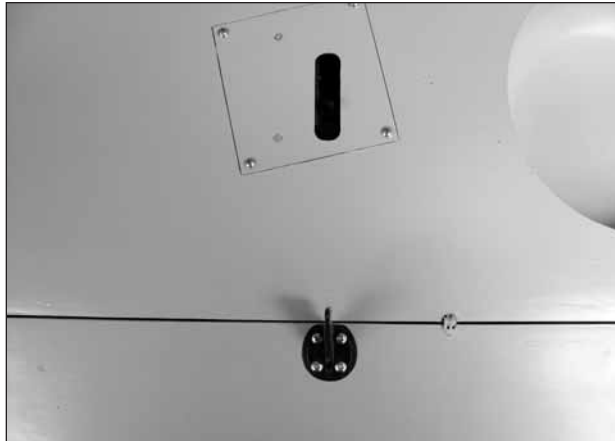

□ □ 11. Install the modified control horn to the flap using the same method used for the aileron.

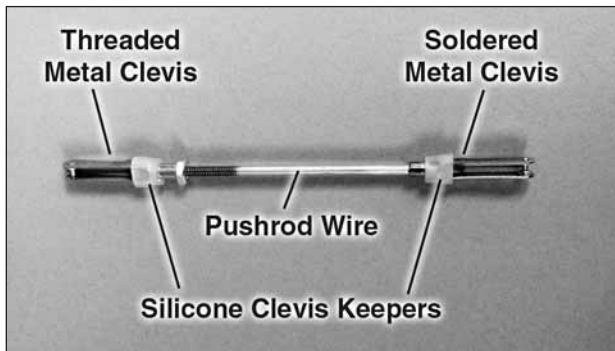

□ □ 12. Each aileron and flap pushrod is made from a 5-3/4" [146mm] pushrod wire threaded on one end, a threaded metal clevis, a 4-40 nut, a metal solder clevis and two silicone clevis keepers.

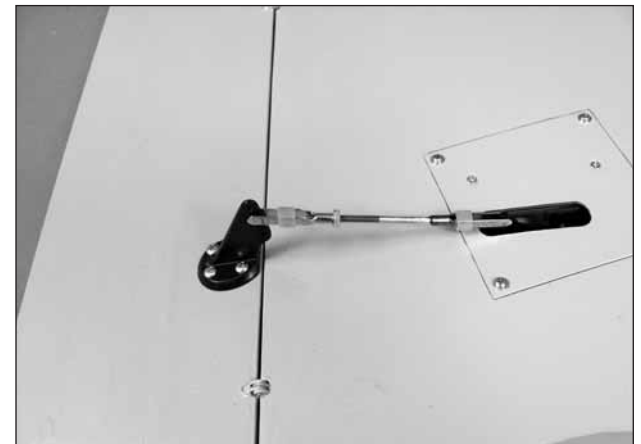
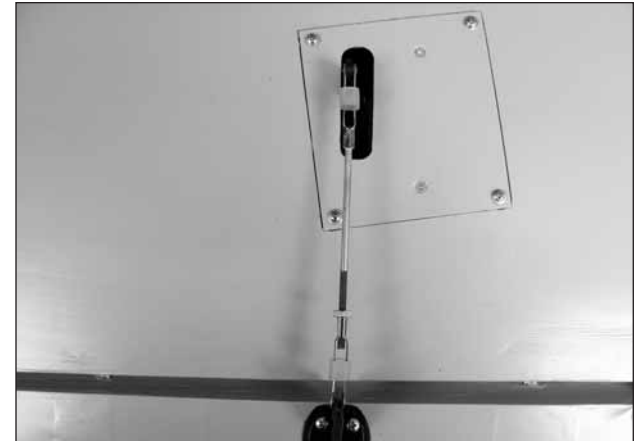

□ □ 13. Screw the 4-40 nut and the threaded metal clevis onto the pushrod wire. Attach the clevis to the third hole from the bottom of control horn. Attach the metal solder clevis into the outer hole of the aileron servo arm. Center the aileron servo arm and the aileron. Mark on the pushrod wire where to cut the wire. Remove all of the pushrod wire components. Solder the metal solder clevis to the pushrod. If you are not familiar with soldering, follow the "Hot Tip" that follows. After the solder cools, apply threadlocker to the threaded wire and tighten the nut against the clevis.



Hot Tip

HOW TO SOLDER

1. Use denatured alcohol or other solvent to thoroughly clean the pushrod. Roughen the end of the pushrod with coarse sandpaper where it is to be soldered.

2. Apply a few drops of soldering flux to the end of the pushrod, then use a soldering iron or a torch to heat it. "Tin" the heated area with silver solder by applying the solder to the end. The heat of the pushrod should melt the solder – not the flame of the torch or soldering iron – thus allowing the solder to flow. The end of the wire should be coated with solder all the way around.

3. Place the clevis on the end of the pushrod. Add another drop of flux, then heat and add solder. The same as before, the heat of the parts being soldered should melt the solder, thus allowing it to flow. Allow the joint to cool naturally without disturbing. Avoid excess blobs, but make certain the joint is thoroughly soldered. The solder should be shiny, not rough. If necessary, reheat the joint and allow to cool.

4. Immediately after the solder has solidified, but while it is still hot, use a cloth to quickly wipe off the flux before it hardens. **Important:** After the joint cools, coat the joint with oil to prevent rust. **Note:** Do not use the acid flux that comes with silver solder for electrical soldering.



This is what a properly soldered clevis looks like – shiny solder with good flow, no blobs and flux removed.

□ □ 14. Once the solder has cooled slide a silicone clevis keeper over each clevis. Install the pushrod wire assembly to the aileron servo arm and aileron control horn.

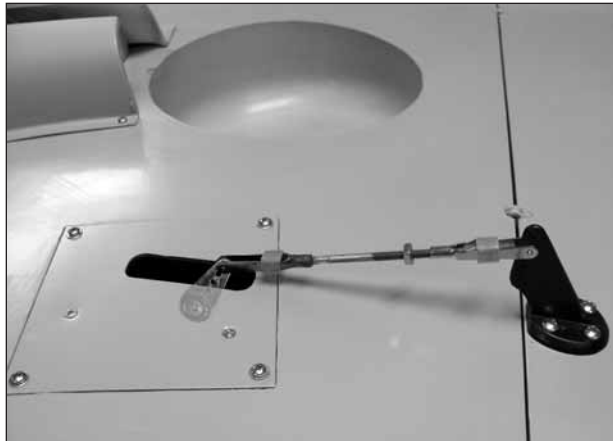
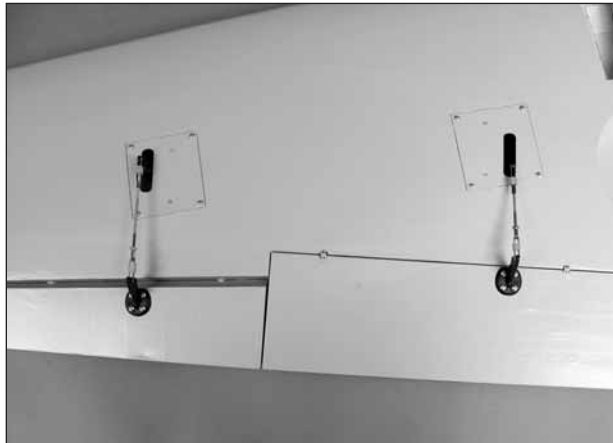

□ □ 15. Use the same procedure for the flap servo except you will not center the servo. Instead, make sure the flap is fully closed to the bottom of the wing. Then, position the servo arm so that it is rotated toward the wing trailing edge. Now you can proceed with making the pushrod wire assembly.

□ 16. Repeat steps 1-15 for the left wing.

You now need to make a decision on the type of landing gear you will be installing. We provide fixed wire landing gear as part of the kit. The retractable rotating landing gear that is available from Robart really is a great addition to the looks and the realism of this airplane. You can choose to install the fixed landing gear and upgrade to the Robart landing gear in the future if you wish to. Both gears are interchangeable in the mount.

If you will be installing the fixed wire landing gear, continue with the next step. If you will be installing the retractable landing gear, skip ahead to the next section. "INSTALL THE RETRACTABLE LANDING GEAR".

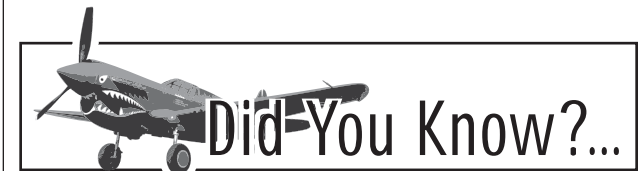

The P-40 was a relatively clean design, and was unusual for its time in having a fully retractable tail wheel. One hundred and ninety-seven P-40s were built in 1939-40 for the USAAF, and many more were sold abroad to Britain and France.

INSTALL THE FIXED WIRE LANDING GEAR

IMPORTANT! The first step in the installation of the landing gear is to identify which blocks go into each wing half. This is the most critical part of the landing gear installation. If you ever choose to upgrade to the Robart retractable landing gear, the blocks must be installed as shown.

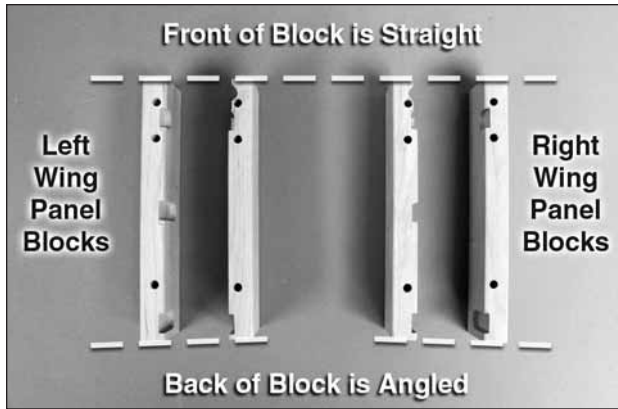

❑❑ 1. Locate the four hardwood **landing gear blocks**. Place them on your work bench exactly as shown in the picture. You will notice that the front of the block is square and the back of the block is angled. You will also notice that there are a number of router cuts in the blocks. Examine the picture closely to be sure the blocks are just as shown in the picture.



❑❑ 2. Install the blocks for the right wing panel into the opening as shown. If you have the correct blocks, the angled end of the block should match the angle of the opening in the wing.



❑❑ 3. Install one of the **aluminum/fiber landing gear** mounts between the landing gear blocks. Temporarily secure the landing gear block and the landing gear mount with six 8-32 x 2-1/2" [64mm] socket head cap screws.

❑❑ 4. Repeat steps 1-3 for the left wing panel.



❑❑ 5. Double-check both of the landing gear block installations to be sure they are correct. When you are satisfied with the installation remove the bolts from the right wing panel. Mix a 1/2 ounce [4 drams] of 30-minute epoxy. Use an epoxy brush to apply a film of glue to the bottom of the landing gear mounting blocks and to the rails in the wing as well as the sides of the box the mounts slide into. Be careful not to get glue into the blind nuts. If you get glue into the threads of the

bolts or blind nuts, it will be very difficult to remove the mounting bolts. As a precaution, you might consider applying a small amount of petroleum jelly or lightweight oil to the threads of the bolts before installing them. Place the wood blocks in position on the rails. Place the aluminum/fiber landing gear block between the mounts. Secure the components to the wing with six 8-32 x 2-1/2" [64mm] socket head cap screws, #8 flat washers and #8 lock washers.

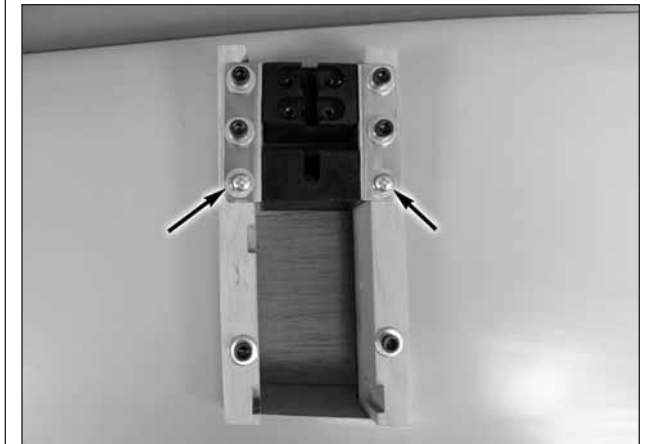

❑❑ 6. Drill a 7/64" [2.8mm] hole through each of the two rear mounting holes of the landing gear. Insert two #6 x 1/2" screws, #6 lock washers and #6 flat washers.



❑❑ 7. Insert the **landing gear wire** into the hole in the landing gear block. The axle of the wire must be

pointing toward the wing tip. If it does not, you have the wrong wire. Install two aluminum landing gear straps into the block and screw them to the block with four #6 × 1/2" [13mm] screws.

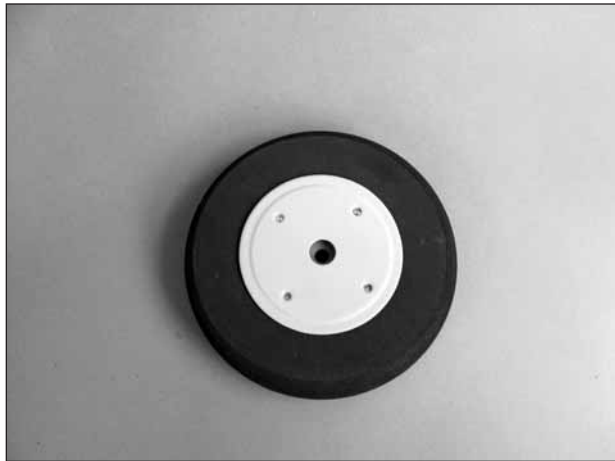
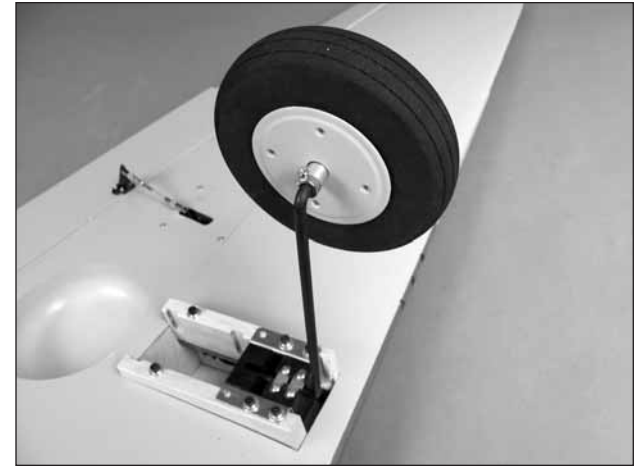

□ □ 8. Slide a 6mm [15/64"] wheel collar onto the axle followed by a 5/8" [16mm] long aluminum tube. Slide the wheel onto the axle. Insert a 3mm × 5mm phillips head screw into another 6mm wheel collar and then secure the wheel collar to the **end of the axle**.

□ □ 9. Slide the aluminum tube and the wheel collar on the inside of the wheel against the wheel. Mark the location of the wheel collars onto the axle and remove the wheel, collars and aluminum tube.

□ □ 10. At the location of the wheel collars make a flat spot on the axle. A high-speed motor tool or small file works well for this.

□ □ 11. Locate two of the wheel covers and the wheel. Screw the wheel cover with the large hole into the pre-drilled holes in the wheel with four 2mm × 4mm Philips head screws.

□ □ 12. Slide one of the 6mm wheel collars with the 3mm × 5mm phillips head screw threaded into it onto the axle, followed by the 5/8" [16mm] long aluminum tube. Slide the wheel onto the axle and another wheel collar and set screw. Apply threadlocker to the set screws, then tighten the set screws in the wheel collars against the flat spot you made in the axle.

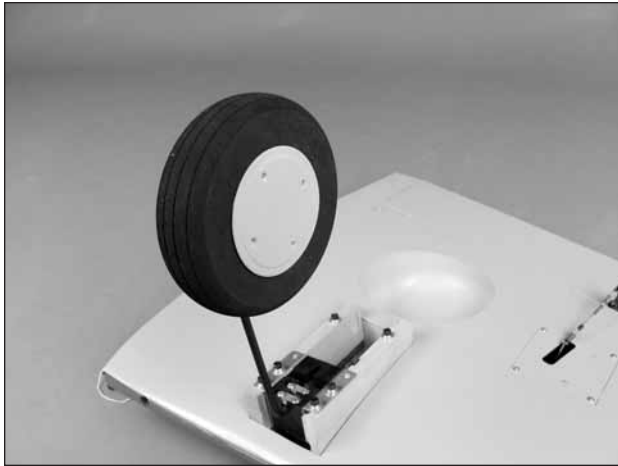

☐☐ 13. Secure the outer wheel cover to the wheel with four 2mm × 4mm Philips head screws.

☐☐ 14. Repeat steps 5-13 for the left wing panel.

If you have installed the fixed wire landing gear, skip ahead to “MOUNT THE WING NACELLES”

INSTALL THE RETRACTABLE LANDING GEAR

IMPORTANT! The first step in the installation of the landing gear is to identify which blocks go into each wing half. This is the most critical part of the landing gear installation. If these blocks are not installed properly the landing gear will not fit properly into all of the cut-outs in the blocks. Follow these instructions exactly to insure the landing gear will fit properly.

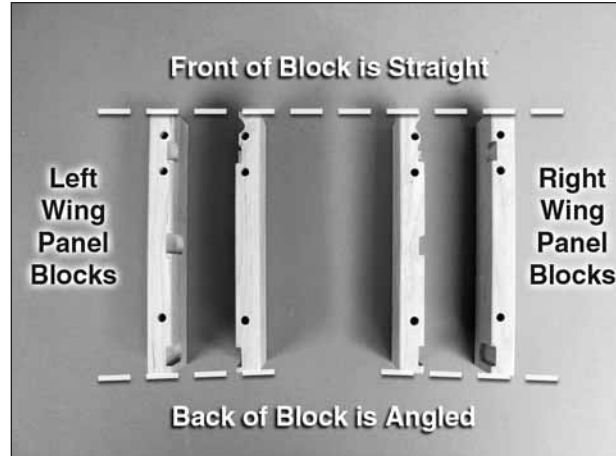

☐☐ 1. Locate the four hardwood **landing gear blocks**. Place them on your work bench exactly as shown in the picture. You will notice that the front of the block is square and the back of the block is angled. You will also notice that there are a number of router cuts in the blocks. Examine the picture closely to be sure the blocks are just as shown in the picture.

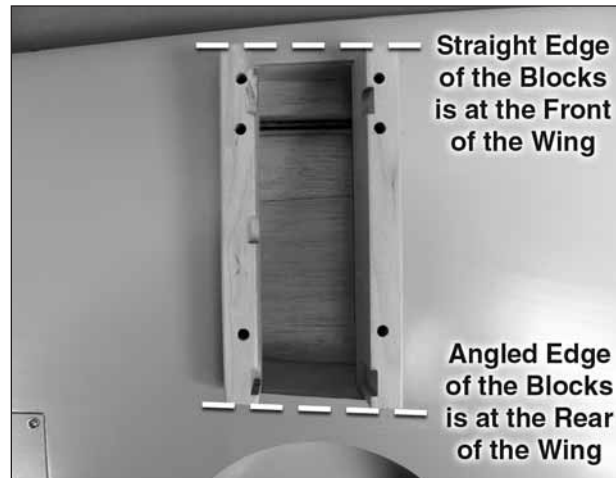

☐☐ 2. Install the blocks for the right wing panel into the opening as shown. If you have the correct blocks the angled end of the block should match the angle of the opening in the wing.



☐☐ 3. Install the right side **landing gear** between the mounting blocks. The landing gear fits between the blocks best if you install it with the gear retracted. Mount the landing gear and the blocks with six 8-32 × 2-1/2 [64mm] socket head cap screws, #8 flat washers and #8 lock washers.

☐☐ 4. Repeat steps 1-3 for the left wing panel.

☐☐ 5. Double check both of the landing gear block installations to be sure they are correct. Make sure that the landing gear move smoothly in and out of the wing. When you are satisfied with the installation remove the bolts and the landing gear from the right wing panel. Mix a 1/2 ounce [4 drams] of 30-minute epoxy. Use an epoxy brush to apply a film of glue to the bottom of the landing gear mounting blocks and to the rails in the wing as well as the sides of the box the mounts slide into. Be careful not to get glue into the blind nuts. If you get glue into the threads of the bolts or blind nuts it will be very difficult to remove the mounting bolts. As a precaution you might consider applying a small amount of petroleum jelly or lightweight oil to the threads of the bolts before installing them. Place the blocks in position on the rails. Place the landing gear between the mounts. Secure the components to the wing with six 8-32 × 2-1/2" [64mm] socket head caps screws, #8 flat washers and #8 lock washers.

☐☐ 6. Repeat step five for the left wing. Set the wings aside and allow the glue to cure. Move onto the next step after the glue has completely cured.

□ □ 7. Remove the landing gear from the right wing panel.

□ □ 8. If you have purchased the Robart air pressure tubing, cut a piece of the red and blue line to a length of 18" [457mm]. Cut the remaining line in half, leaving you with two red and purple lines approximately 20" [508mm] long.

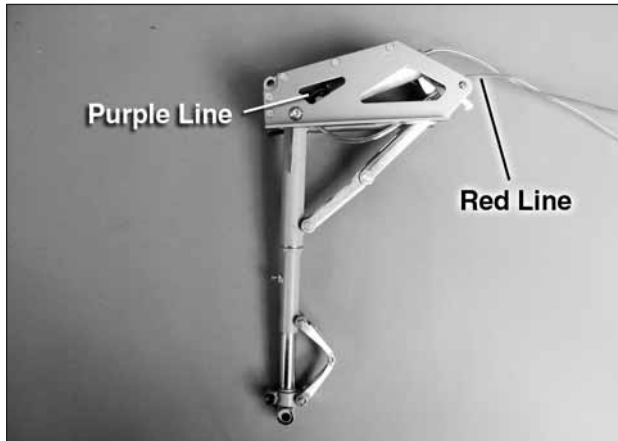

□ □ 9. Install the purple line to the fitting on the front of the air cylinder and the red line to the rear fitting.

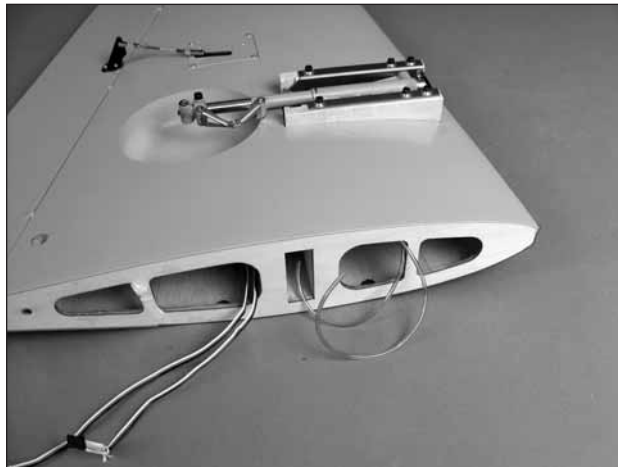

□ □ 10. Re-install the landing gear to the blocks with the six 8-32 x 2-1/2" [64mm] socket head cap screws, #8 flat washers and #8 lock washers. Pull the air line through the wing, exiting at the wing root.

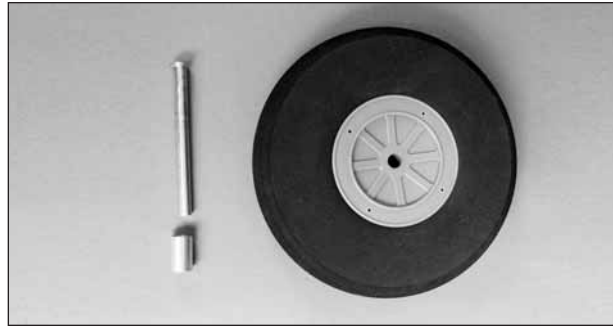

□ □ 11. Locate a wheel, the 5/8" [16mm] long aluminum tube and the axle included with the landing gear. Slide the axle into the wheel and slide the aluminum tube over the axle.



□ □ 12. Slide the wheel and axle into the landing gear. Make a mark on the axle where it needs to be cut to make it flush with the landing gear.

□ □ 13. Cut off the end of the axle. A high-speed motor tool and cut off wheel works well for this.



□ □ 14. Determine where the set screw makes contact with the axle. Make a flat spot on the axle with a file or motor tool.



□ □ 15. Locate two of the wheel covers and the wheel. Screw the wheel cover with the large hole into the pre-drilled holes in the wheel with four 2mm x 4mm Philips head screws.



□ □ 16. Slide the axle into the wheel from the side without the wheel cover; then, slide the aluminum tube over the axle.



☐☐ 17. Insert the axle and wheel into the landing gear. Apply a drop of threadlocker onto the set screw; then, tighten the set screw against the flat spot on the axle.

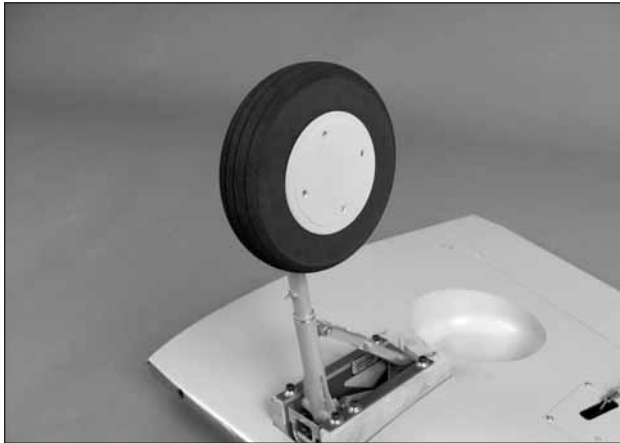

☐☐ 18. Install the remaining cover to the outside of the wheel with four 2mm × 4mm Philips head screws.

☐☐ 19. Repeat steps 7–18 for the left wing panel.

MOUNT THE WING NACELLES

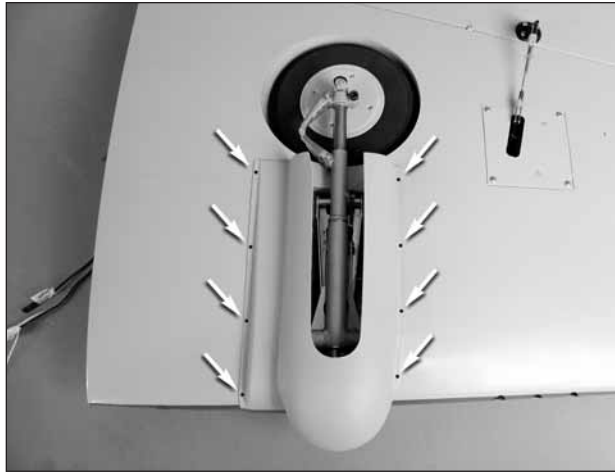

☐☐ 1. Examine the two fiberglass **landing gear nacelles** and determine which goes on each wing. Drill four 5/64" [2mm] holes through the flange on each side of the nacelle as shown.

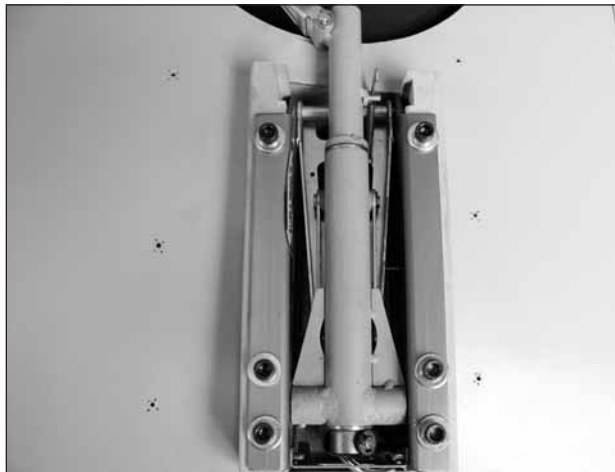

☐☐ 2. Place the right nacelle over the landing gear on the right wing. Be sure to center the nacelle to the landing gear. Once you are satisfied with the location. Drill a 1/16" [1.6 mm] hole through each of the holes in the flanges, into the wing surface.

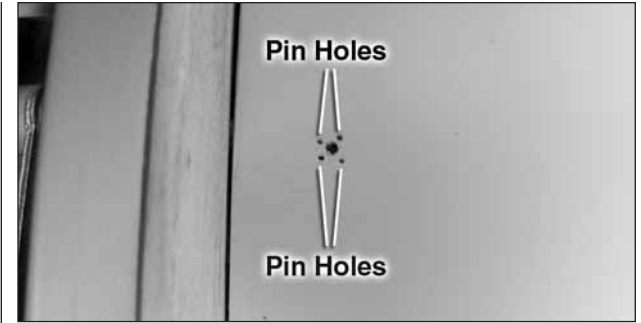

☐☐ 3. Insert and then remove a #2 × 3/8" [9.5mm] screw into each of the holes in the wing. Around each of the holes you made pierce four holes with a pin. Apply a drop of thin CA glue into the holes, allowing the glue to harden the threads you just made in the balsa wing skin. Allow the glue to cure.

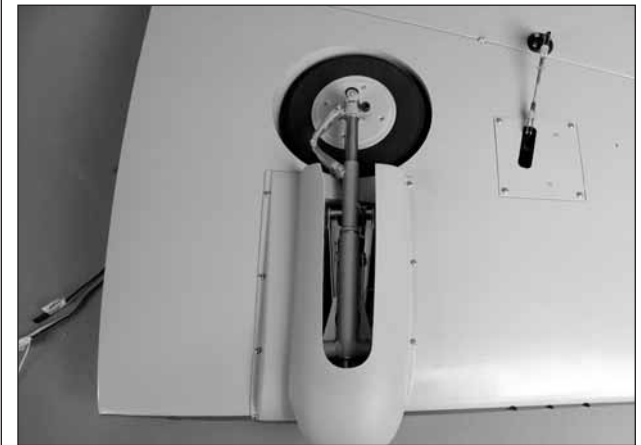

☐☐ 4. Mount the nacelle to the wing with eight #2 × 3/8" [9.5mm] screws. In our model development we found that the procedure of strengthening the wood with thin CA allowed the nacelles to be held securely by the screws. If you feel that your engine may have excessive vibration potentially causing the screws to back out, or would like to add extra holding strength to the nacelles you can apply a thin bead of R/C 56 glue to each flange. If you should ever need to remove the nacelle you can slide a knife blade under the flange to free the glue bond.

☐☐ 5. Repeat steps 1–4 for the left wing.

JOIN THE WING HALVES

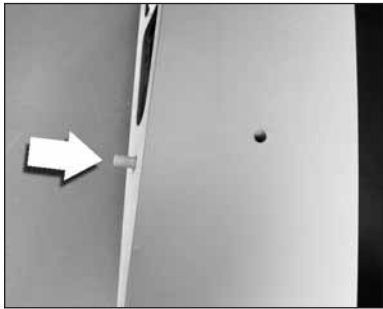

❑ 1. Glue the 1/4" x 3/4" [6mm x 19mm] dowel into the hole at the rear of the root rib in the right wing.

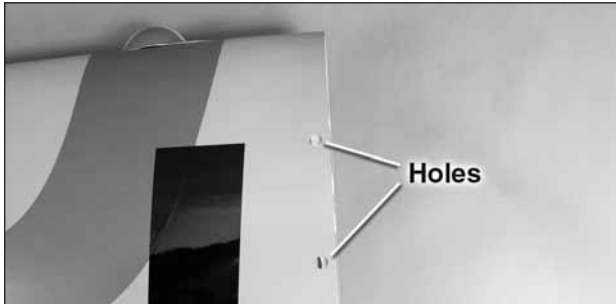

Holes

❑ 2. You will see two holes in the left wing panel. These holes are to allow the servo leads and the air lines to exit the wing. **Important:** Be sure that you feed all of the servo leads and all of the air lines through these two holes before gluing the wings together in the next step.



Leading Edge of the Wing

Front of Joiner

Trailing Edge of the Wing

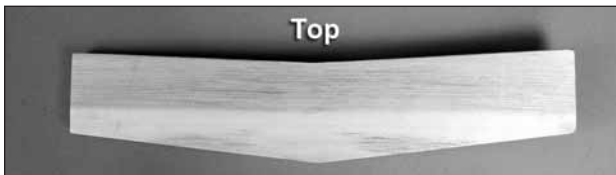

Top

❑ 3. Locate the **hardwood wing joiner** and examine these pictures to understand how to install the joiner into the wings. Test fit the joiner into the wings.

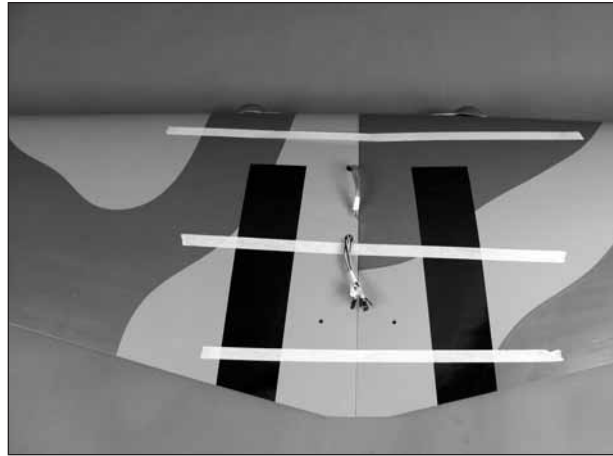

❑ 4. When you are satisfied with the fit of the joiner, glue the joiner into the wing joiner pockets with 30-minute epoxy. When gluing the wings together be sure that you use plenty of glue in the joiner pockets, the joiner and the root ribs of the wing. Use masking tape to hold the wings together while the glue cures.

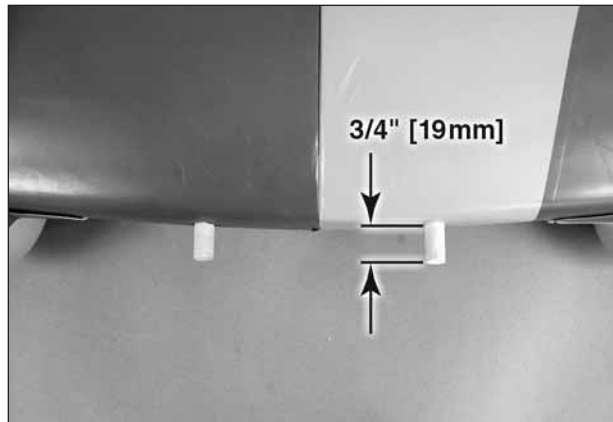

3/4" [19mm]

❑ 5. Test fit the two 3/8" x 2" [9.5mm x 51mm] wood dowels into the two holes in the leading edge of the wing. Place them into the holes so that 3/4" [19mm] of the dowel extends out of the wing. Make a mark on the dowel to indicate this distance. Remove the dowel; then, apply epoxy into the holes and on the dowel. Slide the dowel into the hole leaving 3/4" [19mm] extending from the wing. Clean off any excess epoxy with denatured alcohol and a paper towel.



❑ 6. Mount the wing to the fuselage with the two 1/4-20 x 2" [51mm] nylon wing bolts. Locate the fiberglass belly pan. Place it on the wing. With a fine-tip felt pen, mark the location on the wing for the belly pan.

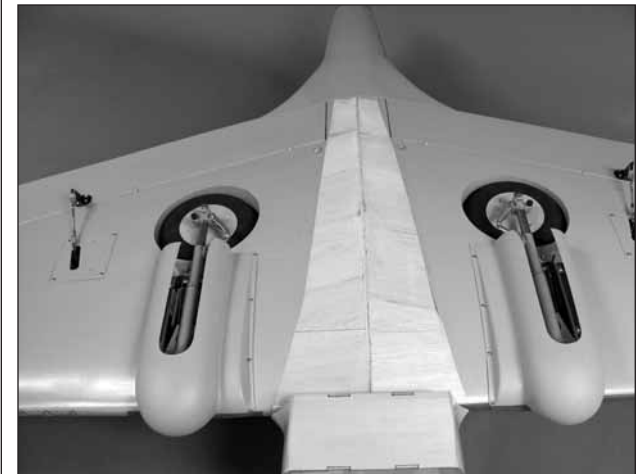

❑ 7. Following the instructions for cutting MonoKote in the "Hot Tip" that follows, carefully cut the covering from the wing, making sure you do not cut the wing skin. **IMPORTANT: Cutting the wing skin will severely weaken the structure.**

HOW TO CUT COVERING FROM Balsa



Use a soldering iron to cut the covering from the stab. The tip of the soldering iron doesn't have to be sharp, but a fine tip does work best. Allow the iron to heat fully. Use a straightedge to guide the soldering iron at a rate that will just melt the covering and not burn into the wood. The hotter the soldering iron, the faster it must travel to melt a fine cut. Peel off the covering.

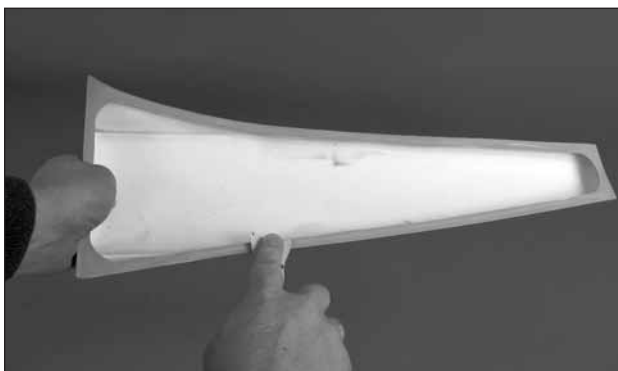

❑ 8. Lightly scuff the flange of the fiberglass belly pan with 220-grit sandpaper. Wipe off the residue with a paper towel wetted with denatured alcohol.



❑ 9. Apply epoxy to the belly pan flange. Then glue the belly pan in place on the fuselage. Tape the belly pan in place until the glue cures.

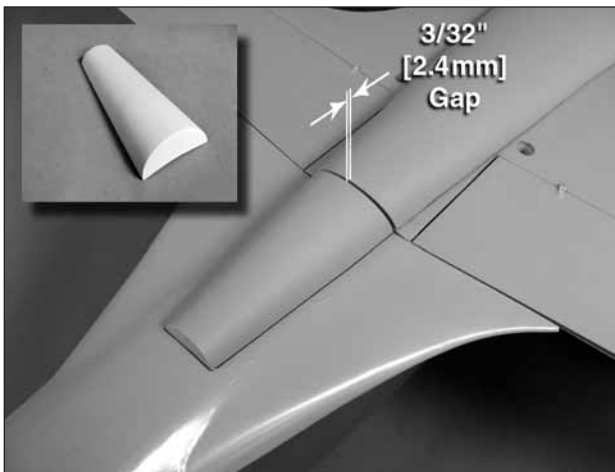

❑ 10. Locate the **rear fiberglass belly pan** and place it in position on the fuselage behind the belly pan you just glued in place. Mark the location on the fuselage and cut the covering away using the same technique used for the main belly pan. Glue the rear belly pan in place. Tape it in place behind the main belly pan. You should maintain a gap between the belly pans of $3/32$ " [2.4mm]. After the glue has cured remove the wing from the fuselage.

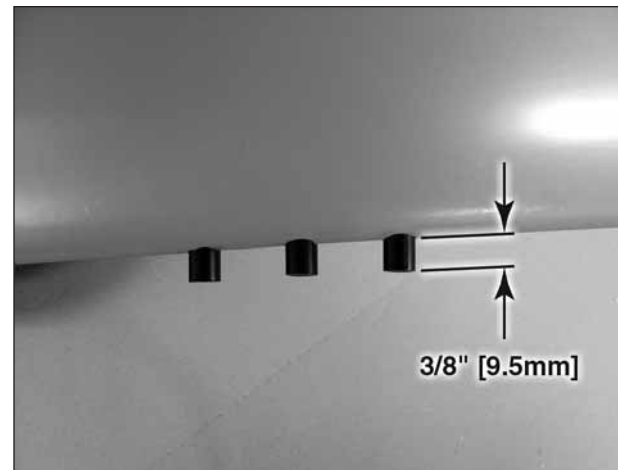

❑ 11. Locate six $3/8$ " \times $1-3/4$ " [9.5mm \times 44mm] black tubes. These tubes replicate the machine guns. Test fit a tube into each of the holes in the leading edge of the wing. Once you are satisfied with the fit, glue a tube into each hole. Leave $3/8$ " of the tube extending beyond the leading edge of the wing.



❑ 12. Install the Robart T-fittings and quick connect air line connectors to the air lines from the landing gear.

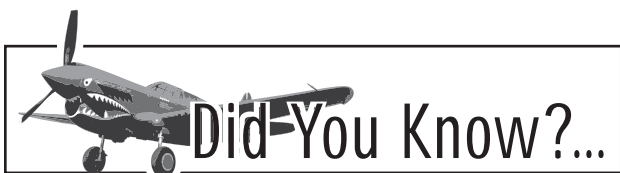

In the middle of 1941, General Claire Chennault began recruiting for his Volunteer Group—better known as the Flying Tigers—to fight the Japanese from China, for which 100 P-40s were ordered for purchase through a loan from the U.S. Government.

ASSEMBLE THE FUSELAGE

INSTALL THE STABILIZER

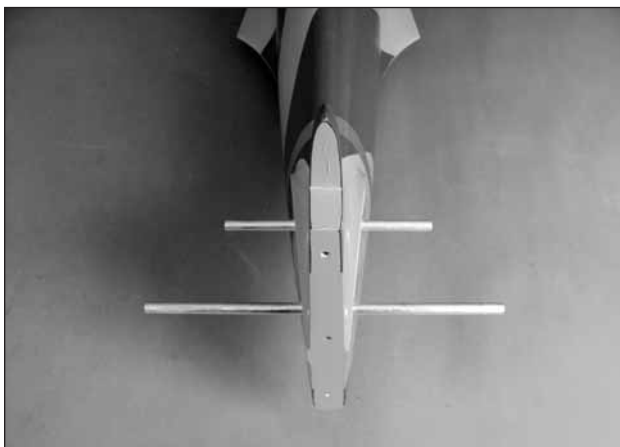
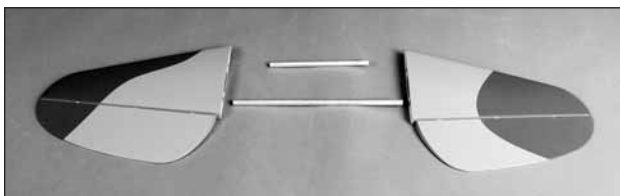

❑ 1. Test fit the two aluminum stabilizer tubes in the **fuselage** and slide the **stabilizers** onto the tubes. The shorter tube goes in the front hole. If the aluminum tubes are too tight to slide through the holes, take a sharp hobby knife and gently scrape the inside of the holes. During the manufacturing process a small amount of resin or filler may be left behind in the hole.

❑ 2. Once you are satisfied with the fit of the stabilizer halves, remove the stabilizer halves and joiner tubes. Use medium grit sandpaper to roughen up the aluminum tubes. Clean the tubes with denatured alcohol and insert both tubes back into the fuselage until the end exits on the opposite side by approximately 1" [25.4mm].

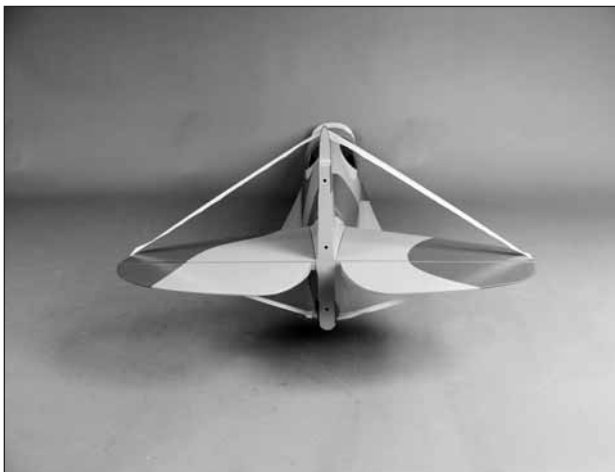

❑ 3. Gather everything required for gluing the stabilizer halves to the fuselage, including 30-minute epoxy, mixing sticks, epoxy brush, 12" [305mm] long dowel or wire, masking tape, denatured alcohol and small paper towel squares. Mix up 3/4 oz. [22cc] of 30-minute epoxy. Apply a generous amount of epoxy to the long side of the aluminum joiner tubes. Pull the tubes through the fuselage so that they are close to centered. Pour a small amount of epoxy into both holes of one of the stabilizer halves. Using a dowel or wire, coat the inside of the holes. Apply epoxy to the root rib of the stabilizer and the fuselage. Insert the end of the aluminum tubes with epoxy on them into the stabilizer and press the stabilizer against the fuselage. Wipe off any excess epoxy that may have squeezed out before it runs down the fuselage. Quickly repeat the process on the other side. Wipe off any excess epoxy with a dampened paper towel and denatured alcohol. Use pieces of masking tape to hold the stabilizer halves tight against the fuselage until the epoxy cures.

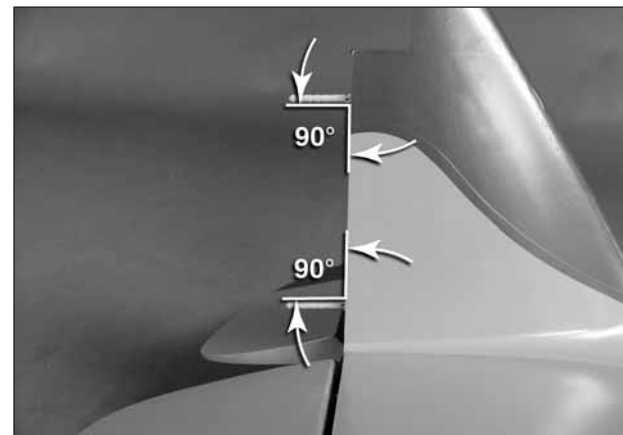

❑ 4. Without using any glue, install three hinges into the holes in the trailing edge of the fin. Note that the pivot point of each hinge must align with the center of the trailing edge. To achieve this alignment, the hinges will be fairly deep in the fin. Also note that the hinges must be perpendicular to the leading edge.

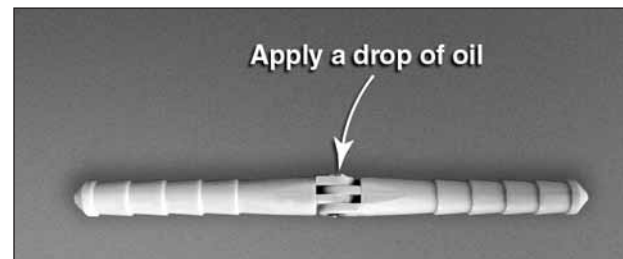

❑ 5. Again without glue, test fit the rudder to the fin. Remove the rudder and all the hinges. Add a small drop

of oil to the pivot point on the hinges. This will prevent the epoxy from adhering to the pivot point. Make sure oil does not get on the gluing surface of the hinge. If it does, clean the oil off with a paper towel square dampened with denatured alcohol.

❑ 6. Mix up approximately 1/4 oz. [7.4cc] of 30-minute epoxy. Use a toothpick to thoroughly apply the epoxy in the holes in the fin and rudder. Use the toothpick to get the epoxy out of the opening of the holes in the rudder and fin so it doesn't get into the hinge pin. Wipe away any excess epoxy around the outside of the holes with a couple of the small paper towel squares dampened with denatured alcohol.

❑ 7. Use the toothpick to apply epoxy to the ends of the rudder hinges that go into the fin. Insert each hinge into the fin and wipe away any excess epoxy that squeezes out of the hole.

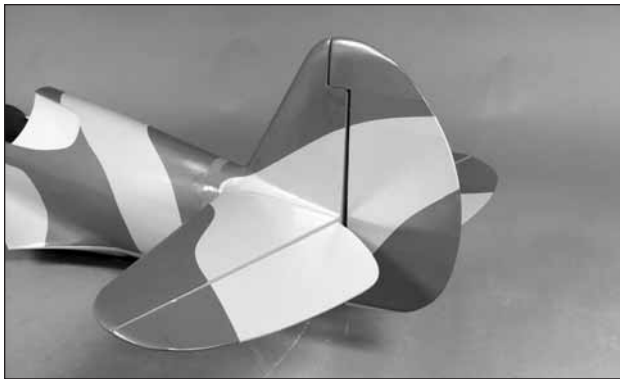

❑ 8. Apply epoxy to the other end of the hinges. Join the **rudder** to the fin, pushing the hinges only about 3/4 of the way into the rudder. Use a toothpick to wipe away any epoxy that squeezes out. Then push the rudder the rest of the way in.

❑ 9. Move the rudder left and right to align the hinges. If needed, use a length of masking tape to hold the rudder to the fin. Allow the glue to fully cure.

INSTALL THE TAIL GEAR ASSEMBLY

We have provided instructions for the installation of the fixed tail gear assembly and the Robart retractable tail

gear. The two tail gears are interchangeable; you can install the fixed gear and upgrade to the retractable gear later if you wish. Proceed to "Mount the Fixed Tail Gear" or if you will be installing the retractable tail gear skip ahead to, "Mount the Retractable Tail Gear".

MOUNT THE FIXED TAIL GEAR

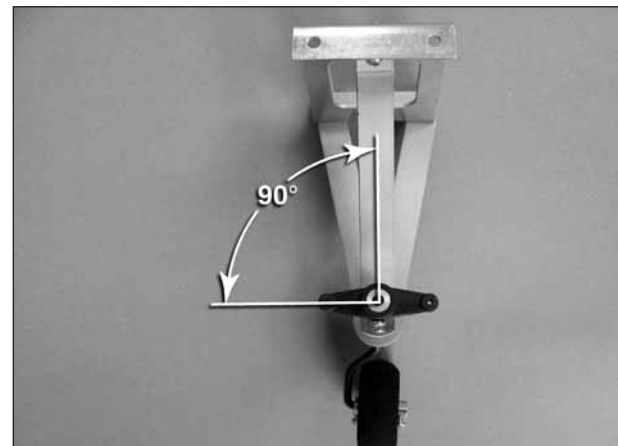

❑ 1. Slide a 3.5mm wheel collar on the tail gear wire. Insert the **tail gear wire** in the **tail gear mount**. Install a second wheel collar followed by the steering arm on the tail gear wire. Apply a drop of threadlocker on three 3mm x 6mm machine screws. Secure the two wheel collars and the steering arm to the tail gear wire with the three 3mm x 6mm machine screws. Adjust the location of the steering arm so that it is flush with

the top of the tail gear wire and perpendicular to the tail wheel. Also, remove the two nuts from the top of the tail gear, apply threadlocker and reinstall the nuts.

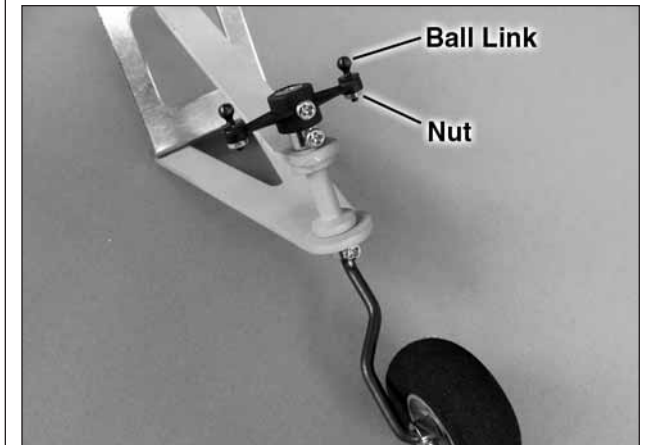

❑ 2. Enlarge the holes in the steering arm with a 5/64" [2mm] drill bit. Mount a 2-56 ball link ball to each arm with a 2-56 nut and a drop of threadlocker.

❑ 3. Skip to step 6 in "**Mount the Retractable Tail Gear**" and follow the steps for installing the pull-pull cable.

MOUNT THE RETRACTABLE TAIL GEAR

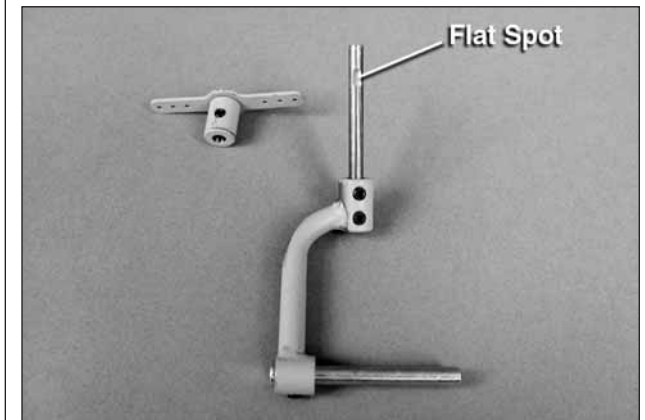

❑ 1. Remove the steering arm from the Robart #160LWC retractable tail gear assembly (not included). File a flat spot near the top of the shaft for the set screw

in the steering arm to lock onto. Mount the steering arm to the shaft with a drop of threadlocker and the set screw.

❑ 2. File another flat spot near the bottom of the shaft for one of the set screws in the strut. Tighten both set screws with a drop of threadlocker on each. Be certain the steering arm and the axle in the strut remain parallel with each other. Make adjustments to the flat spots if necessary.

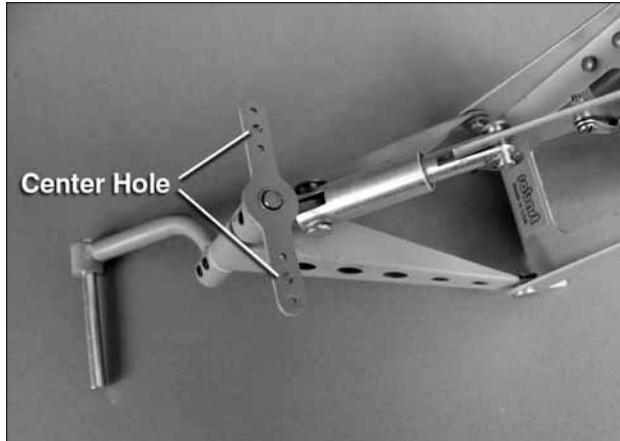

❑ 3. Enlarge the center hole in both sides of the steering arm with a 3/32" [2.4mm] drill.

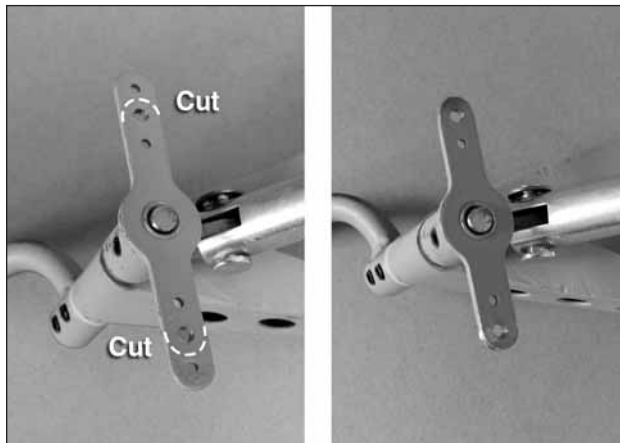

❑ 4. Cut off the part of the steering arm outside of the center hole and re-shape the end of the steering arm.

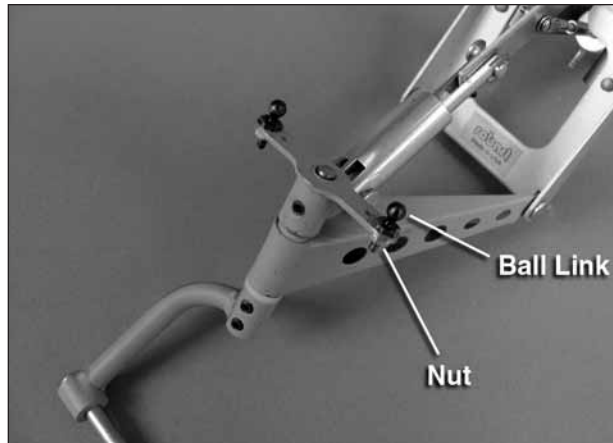

❑ 5. Insert a 2-56 ball link ball in the hole. Secure each ball with a 2-56 nut and a drop of threadlocker

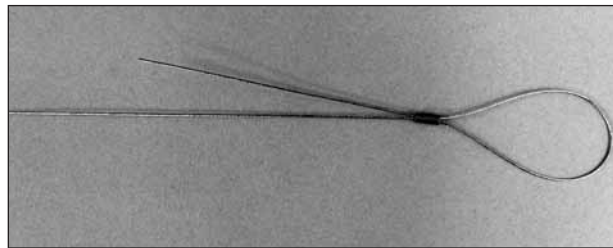

❑ 6. Use wire cutters to cut the supplied braided cable into two equal lengths. Slide a small copper tube (called a swage) over one end of the cables, then guide the end of the cable back through.

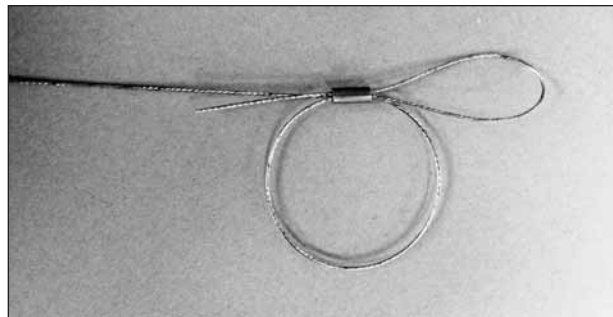

❑ 7. Wrap the cable back around the swage and back through the swage.

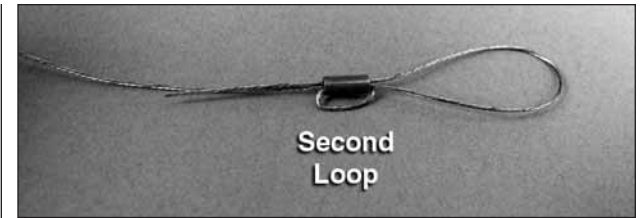

Second Loop

❑ 8. Use pliers to pull the cable from the first loop to reduce the size of the second loop.

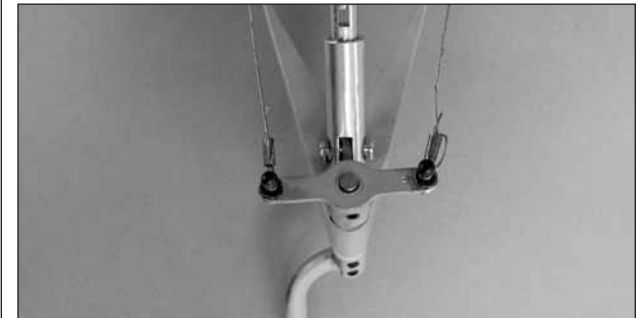

❑ 9. Now pull on the long end of the cable to reduce the size of the first loop. Slip the loop over one of the ball link balls on the steering arm. Tighten the loop until it is small enough to remain secure on the ball, yet may still be pried off. Squeeze the swage with pliers. Connect the other cable to the other ball link ball the same way.

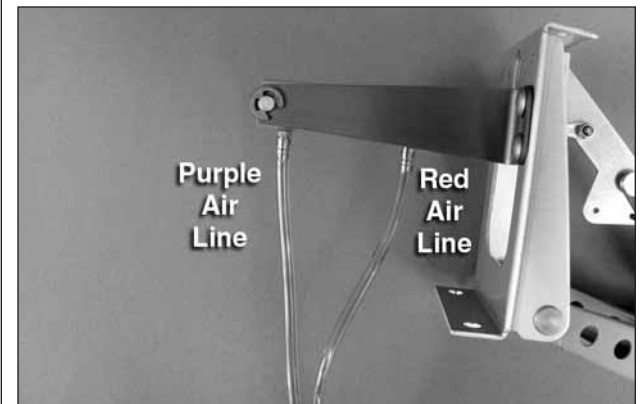

❑ 10. **Retractable tail gear only:** Connect 40" [1016mm] of purple air line to the forward air fitting

and 40" [1016mm] of red air line to the aft fitting on the air cylinder. There is not enough air line left over from the main gear, so additional line will have to be purchased separately (Robart #169 Pressure Tubing).

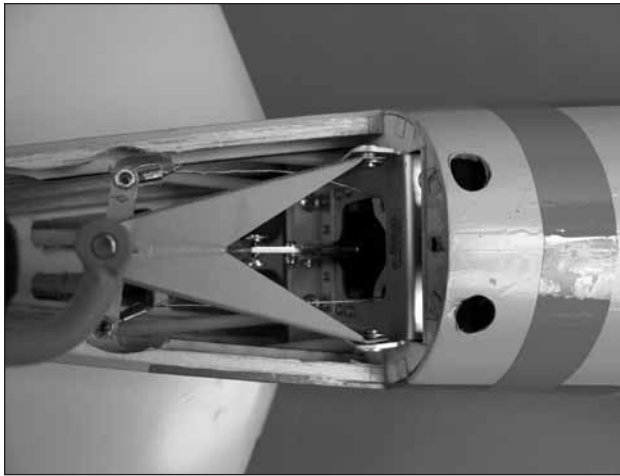

❑ 11. Place the tail gear (fixed or retractable) in the fuselage while simultaneously guiding the pull/pull cable through the white plastic guide tubes. If installing the retractable tail gear, also guide the air lines through the fuselage.

❑ 12. Drill four 3/32" [2.4mm] holes through the rails for mounting the tail gear. If your drill bit is not long enough to reach the rail nearest the top of the fuselage, use medium CA to temporarily glue a 3/32" [2.4mm] drill bit in a 1/8" [3.2mm] brass tube. After drilling the holes, the drill bit can be removed from the tube by heating the tube.

❑ 13. Mount the tail gear in the fuselage with four #6 x 1/2" [12.7mm] sheet metal screws. Enlarge the center hole through the 1-3/4" [44mm] tailwheel with a #9 [5mm] drill. Cut the axle included with the Robart retractable tail gear to the correct length; then, file a flat spot on it and mount it to the strut.

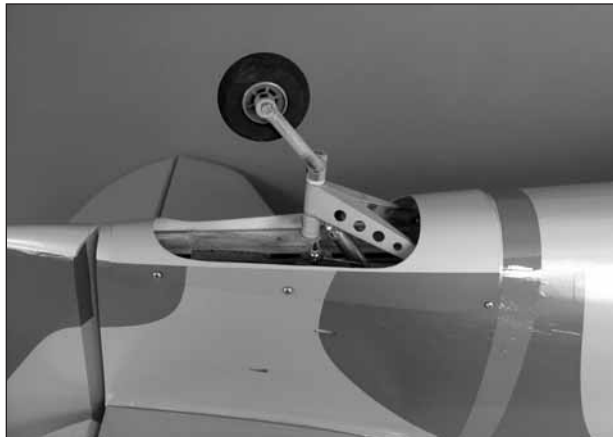
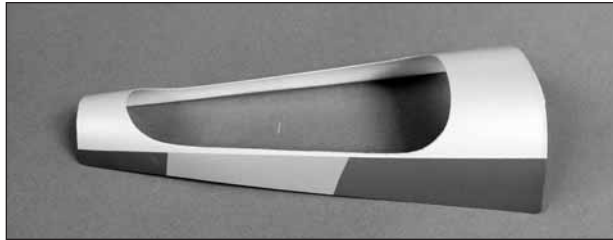

❑ 14. Locate the fiberglass tail gear cover. Place it onto the fuselage making sure you align the color markings on it to the markings on the fuselage. Drill three 1/16" [1.6mm] holes into each side of the cover, drilling through the fuselage. Secure the cover with six #2 x 3/8" [9.5mm] screws. It is recommended that you harden these screw holes in the balsa fuselage with thin CA to be assured the threads are strong. Follow the technique provided on page 6. ("**Assemble the Wing**")

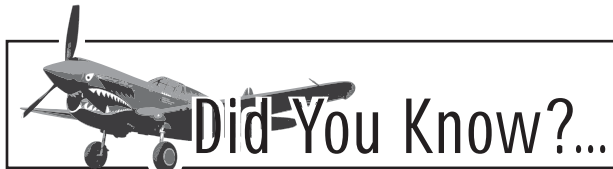

The P-40 Warhawk was a deadly fighting machine in trained hands. The formidable armament of 6 x 12.7mm (.50 caliber) machine guns (up to 200 rounds per gun) was complemented by the ability of the aircraft to carry a bombload for an increasingly expanding workload.

INSTALL THE ELEVATOR & RUDDER SERVOS

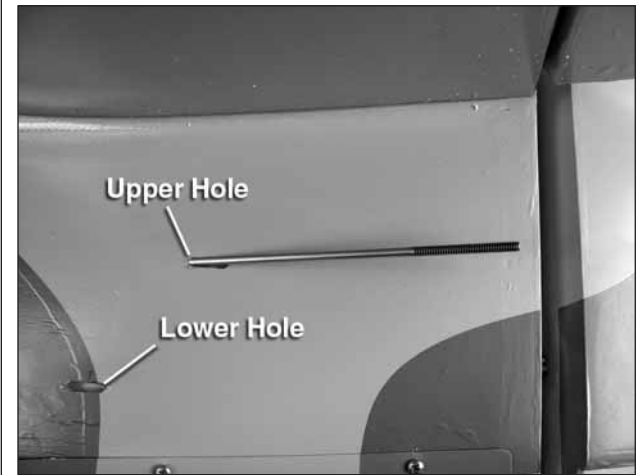

❑ 1. Cut two 4-40 x 48" [1220mm] metal pushrods to a length of 30" [762mm]. Insert the pushrods into the upper pushrod exit holes on each side of the fuselage as shown in the photo.

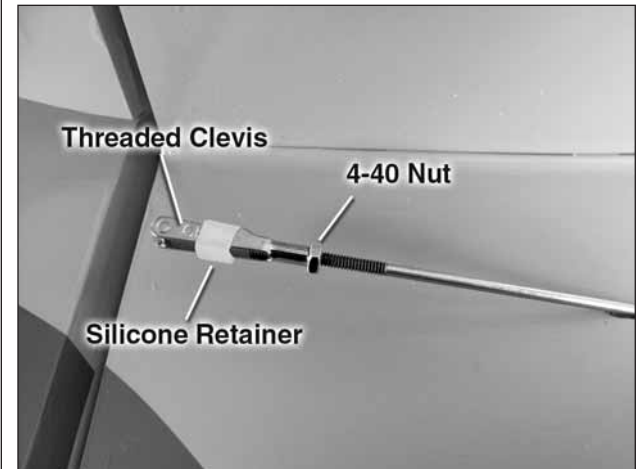

❑ 2. Thread a 4-40 nut, threaded clevis and a silicone clevis retainer, 12 turns, onto both elevator pushrods.

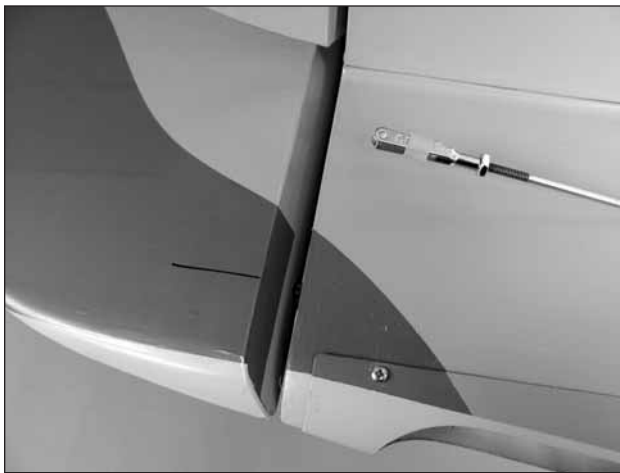

□ 3. Draw a straight line from the lower pushrod hole to the rudder to indicate the position for the rudder control horn. Repeat on the other side of the fuselage and rudder.



□ 4. Mount the control horns to the elevators and the rudder. Follow the same procedure used for the ailerons, by drilling $3/32"$ [2.4mm] holes and using #4 x $1/2"$ [12.7mm] sheet metal screws. Attach the elevator clevis in the third hole from base of the control horn. Don't forget to harden the holes with thin CA after first installing, then removing the screws.

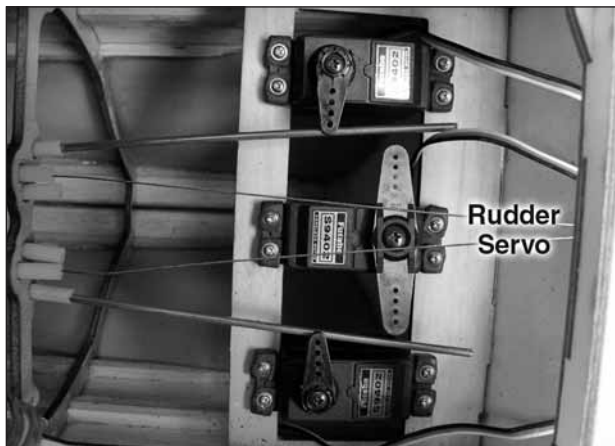

□ 5. Place two elevator and one rudder/tailwheel steering servos in the servo tray as shown. Make two one-arm servo arms from the servo arms that came with your servos. Position the servo arms as shown. A 2" [51mm] servo arm needs to be used on the rudder servo. Many aftermarket servo arms are available. We used the arm included with the Du-Bro Super Strength Servo arm assortment (DUBM6670).



□ 6. Install solder clevises on the elevator servo arms in the outer hole from the center of the servo arm. Following the same procedure that was done for the aileron and flap pushrods, mark the elevator pushrods where they are to be cut for the solder clevises. One at a time, remove the threaded metal clevis from the control horn end, remove the pushrod from the fuselage, cut it to the correct length and solder a metal solder clevis on the end. Re-install the pushrod from the front and connect the solder clevis to the servo arms. Re-install the threaded metal clevis and 4-40 nut. **Don't forget to use a silicone clevis retainer on all the clevises.**

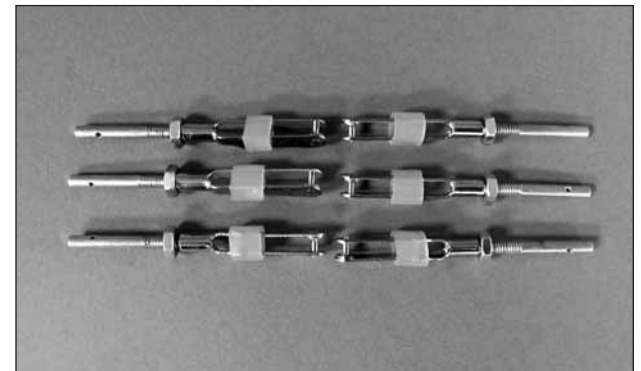

□ 7. Thread a 4-40 nut and a 4-40 metal clevis, 12 turns, onto each of six 4-40 rigging couplers. Install the clevises on the tailwheel steering servo arm in the holes $5/8"$ [15mm] from the center of the servo arm.



❑ 8. Center the servo arm and the tail wheel gear. Install a swage on each cable, securing it following the same procedure used on the tail gear. Use pliers to crimp the swage tightly on the cable.

❑ 9. Locate the remaining coil of braided wire. Cut it into two equal lengths. Using the same technique used on the retractable tail gear, attach a rigging coupler, nut, clevis and silicone clevis keeper to one end of each of the braided wire.

❑ 10. Slide the opposite end of the wire into each of the two remaining plastic tubes in the fuselage. Push the wire through the tube until it exits the tubes at the rear of the fuselage.

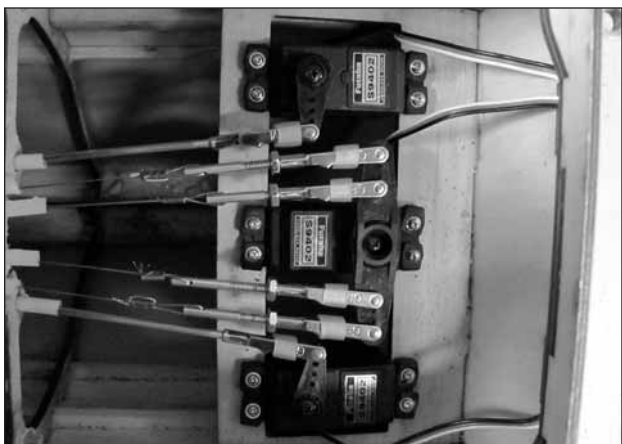

❑ 11. Attach each clevis to the outer hole of the servo arm.



❑ 12. Attach the remaining two clevis assemblies into the middle hole of the rudder control horn on each side of the rudder. Center the rudder and the rudder servo. Attach the wire to each of the clevis assemblies using the same technique used on the other clevis assemblies.

❑ 13. Adjust the tension of the wires and then lock the nut against the clevis.

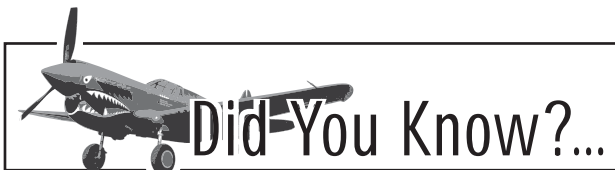

Overall, the various models of the P-40 made it the second most numerous fighter aircraft produced by the Allies during WWII. They had a production run of 13,738.

INSTALL THE ENGINE, MUFFLER, RADIO AND REMAINING SERVOS

The following engine mounting instructions shows the installation of the DLE-55 gas engine. The installation of other brands of engines will be similar and the following instructions can be used as a guide.

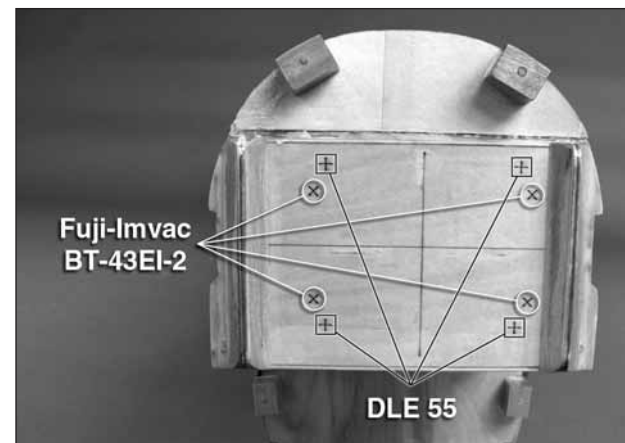

❑ 1. The Giant P-40 ARF firewall has two sets of engine mounting bolt patterns embossed on it. The "+" is for the DLE-55 gas engine and the "x" is for the Fuji-Imvac BT-43EI-2 gas engine. If you are installing an engine with a different mounting bolt pattern, the firewall also has crosshairs embossed on it to help locate the correct mounting location. Drill a 3/16" [4.8mm] hole through the firewall at each location marked with a "+".



❑ 2. We have included 1/8" [3.2mm] plywood spacers to help space different engines out the required distance for the engine to fit the cowl. Drill a 3/16" [4.8mm] hole through the "+" marks on one of the plywood spacers. It's a good idea to fuel proof the spacer. This can be done by brushing a coat of 6-minute epoxy thinned with alcohol, or a coat of paint.

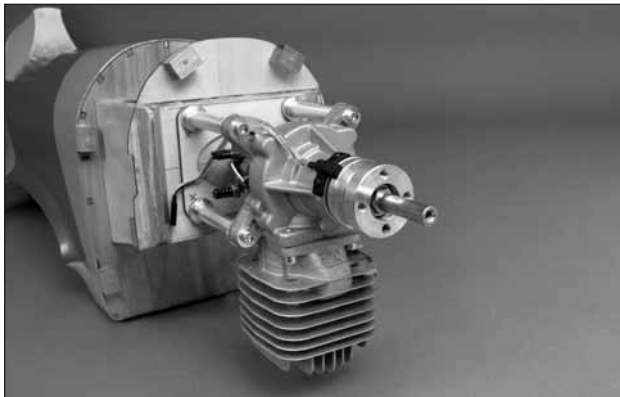
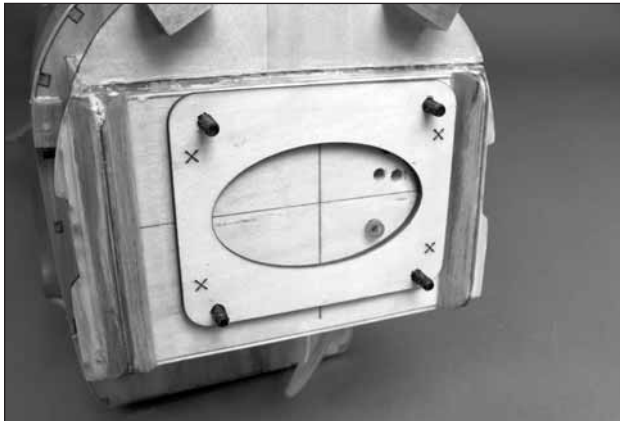

❑ 3. Install 10-32 x 1" [10-32 x 25mm] engine mounting bolts, flat washers and lock washers from the back of the firewall. (The mounting hardware is not included in this kit. It should come with the engine. Most likely the bolts with the engine are too short. You will need to purchase four of the required bolts). Install **two** plywood spacers onto the bolts. Apply a drop of threadlocker to each bolt before installing. **Note:** The photo shows only one plywood spacer installed but two are needed for the installation of the DLE-55.

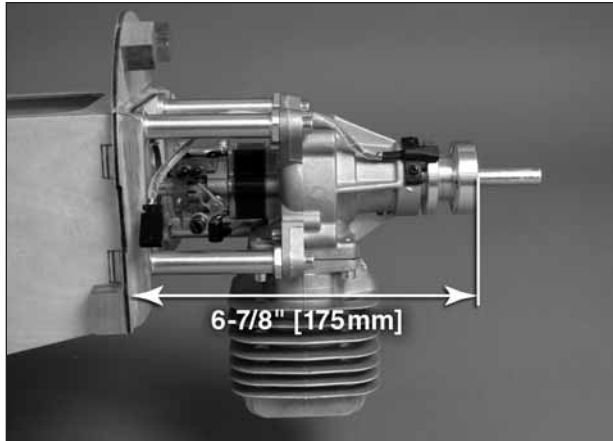

❑ 4. For reference, the distance from the front of the firewall to the front of the drive washer is 6-7/8" [175mm].

Many modelers have their own opinions for connectors and throttle linkage. We have provided materials for a secure and safe throttle linkage. We have also included a method to connect a linkage to the choke. This will require the use of an additional servo for the choke linkage. Some modelers may prefer a mechanical choke linkage. Review the following procedure and then modify it to fit your personal preferences.

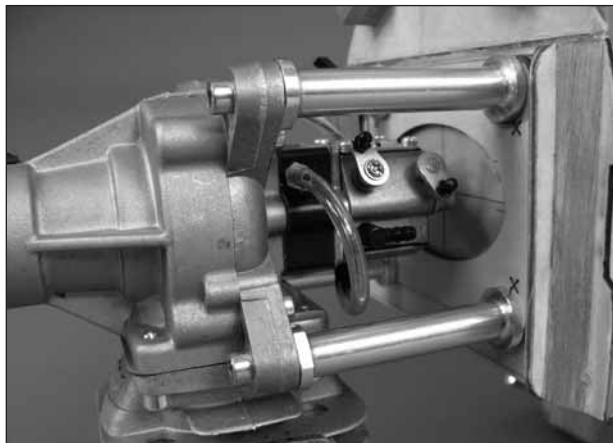

❑ 5. Install a 2-56 ball link and 2-56 nuts to both the throttle and the choke. Be sure to apply a drop of thread-locker to the threads on the ball link.

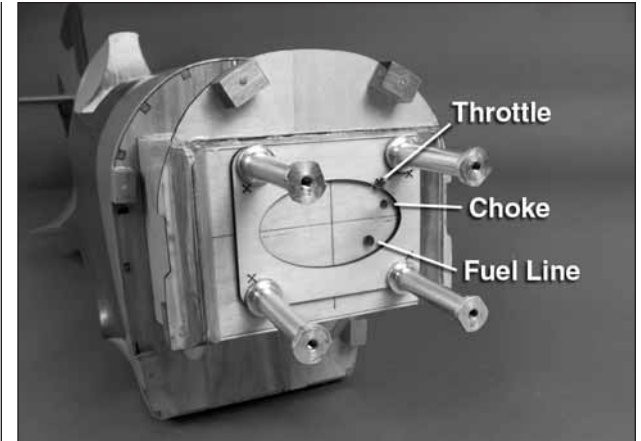

❑ 6. Make marks on the firewall where the throttle, choke and fuel line will pass through. Remove the engine from the standoffs and then drill a 3/16" [4.8mm] hole through the firewall for the throttle and choke. Drill a 1/4" [6.4mm] hole on the mark for the fuel line. (Check the diameter of your fuel line to be sure that a 1/4" [6.4mm] hole is correct).



❑ 7. Install 18" [457mm] of air line onto the end of the air tank. Install the Robart air tank into the cradle in the fuselage. A couple of dabs of silicone sealant (such as Shoe Goo®) can be applied at the front to hold the tank in position, but still allow it to be removed if necessary. A plywood plate will be installed later to secure the tank.

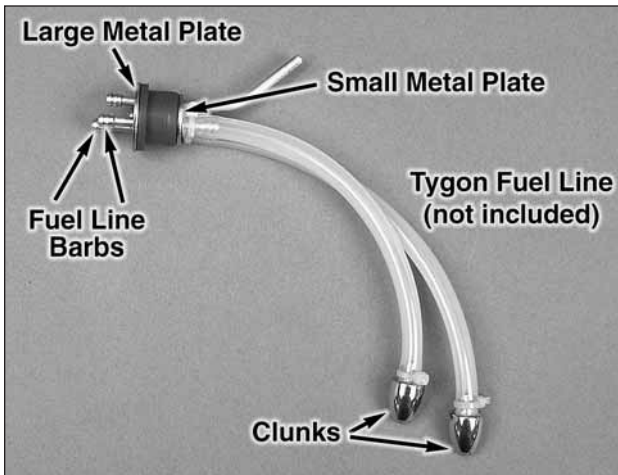
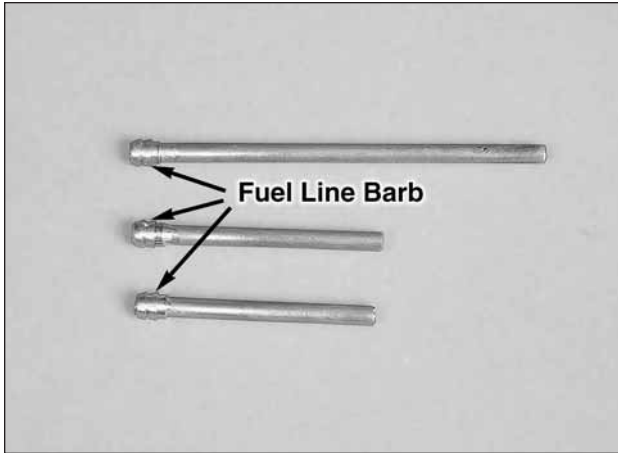

❑ 8. Assemble the fuel tank stopper assembly with the fuel tubes as shown. The easiest way is to first solder a fuel line barb (not included, we used Du-Bro Fuel Barb DUBQ0670) onto **one** end of all three tubes. Insert the tubes into the stopper with the metal plates, and then solder a barb onto the other end of the two short tubes. Bend the vent tube and connect the pickup and fueling/defueling lines (not included) to the short tubes. Connect the clunks to the Tygon Fuel lines (not included) and secure the lines to the clunk and brass tubing with the included small tie straps.

❑ 9. Install the fuel tank stopper assembly in the fuel tank. Check that the clunks move around freely in the fuel tank. Tighten the fuel tank stopper screw.

❑ 10. Install fuel lines onto the brass tubes from the fuel tank. To route the fuel lines as will be shown here you will need to use a 24" [610mm] length of tubing on the fill and vent line and a 6" [152mm] length on the carburetor line.



❑ 11. Install the fuel tank into the opening in the fuselage as shown. Feed the lines through the fuselage up to the firewall. Make sure when you insert the tank that the vent line is at the top of the tank.

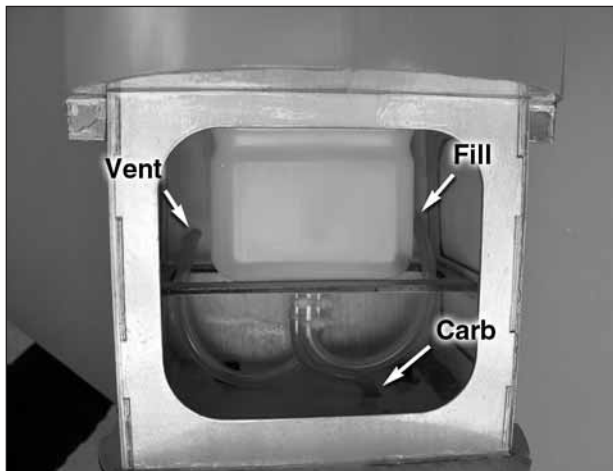

❑ 12. Route the carburetor line through the firewall. Trim it as needed and attach it to the carburetor. Drill two 1/4" [6mm] holes through the bottom of the firewall

box in the bottom of the box as shown. Pass the vent and carburetor lines through the holes.

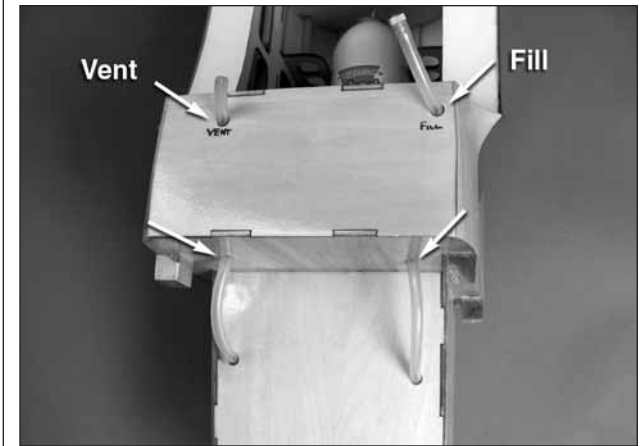

❑ 13. Drill two more holes for each line as shown in the picture. Push the lines through the holes. This installation allows both of the lines to be located under the fuselage. Install the aluminum fuel plug into the fuel/defuel line.

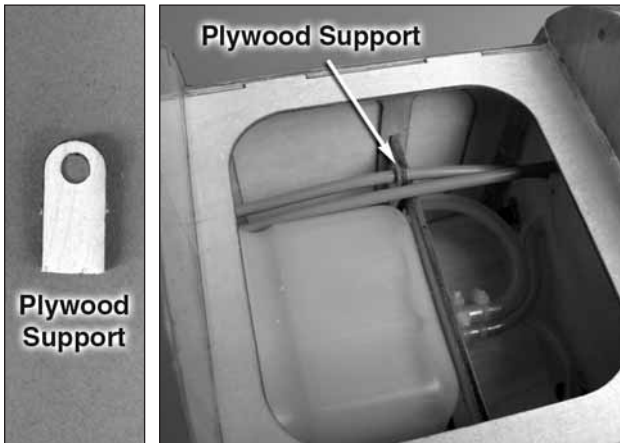
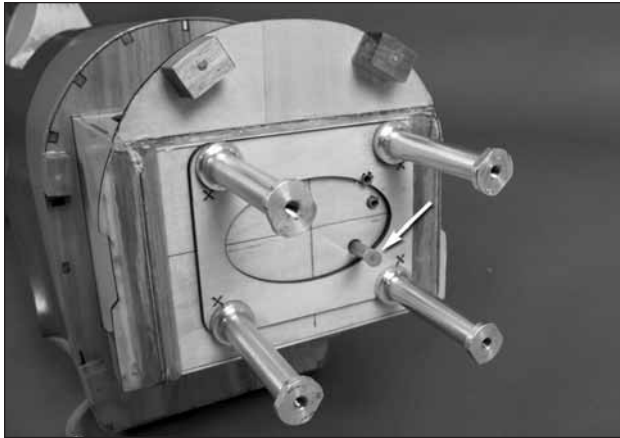

□ 14. From the 36" [610mm] grey plastic tube, cut a piece to a length of 14" [356mm] and another to 10" [254mm]. Insert the 14" [356mm] tube into the hole for the choke. After the tube has passed through the firewall, slide a plywood support over the tube (*Do not glue it in place yet. You will be doing this in a future step.*) Continue to work the tube through the fuselage as shown. (Look at the photo in step 19 to better understand the location for the tubes.) Repeat this with the 10" [254mm] tube, but do not use a plywood support. Both tubes need to be routed around the fuel tank and into the fuselage. Push the tubes into the area of the fuselage around the tank, stopping short of having them reach into the middle of the fuselage.

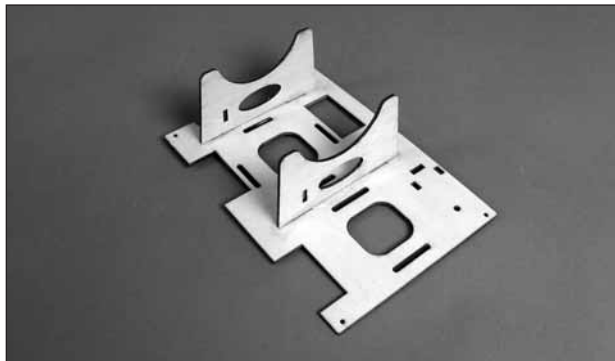
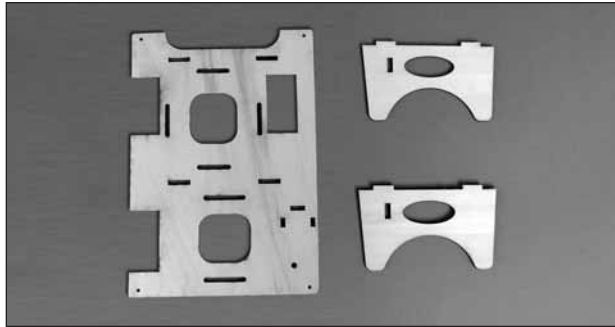

□ 15. Locate the three components of the radio / servo tray. Glue the tray together as shown making sure that you glue the two parts with the arc into the main tray exactly as shown in the photo.

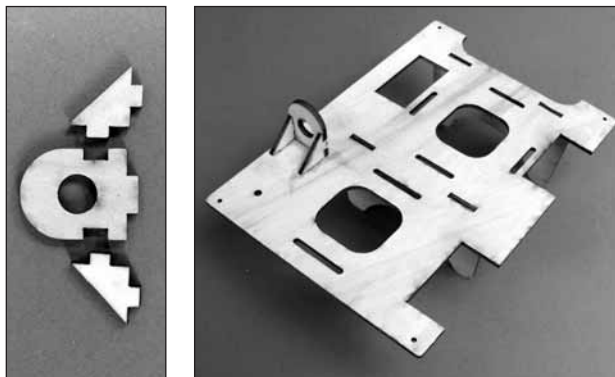

□ 16. Glue three plywood parts together creating a fixture for mounting the air control valve. Glue it in place on the servo tray.

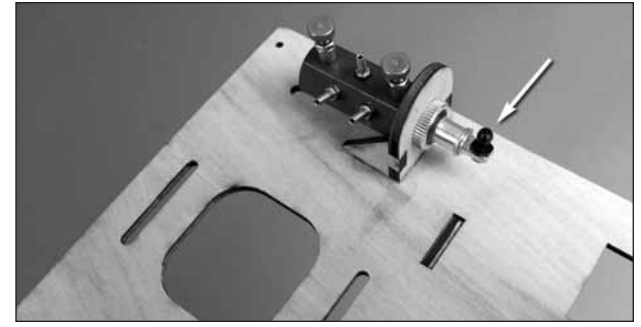

□ 17. Install a .080 metal ball into the hole in the air control valve. Secure it with a .080 nut. Be sure to put a couple of drops of thread locker in the threads before installing the nut. Install the air control valve into the tray.

□ 18. Place the tray into the fuselage. When positioned properly the tray will rest on the air tank.

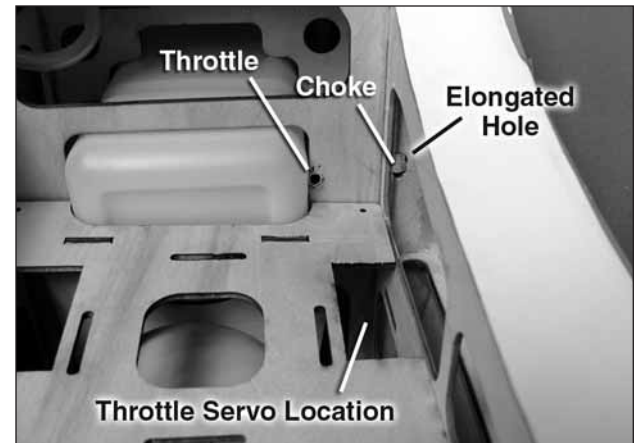

□ 19. The throttle servo will be mounted into the forward opening. The servo arm will be pointing toward the center of the fuselage. With this in mind, carefully make an opening in the fuel tank former for the tube to pass through. This can be done with a drill or a high-speed motor tool. This hole needs to be 3/16" [4.8mm] in diameter. The tube must pass through the former so it aligns with the location of the servo arm. Feed the throttle tube around the tank and into this hole. The tube must be flush with the former. Glue the tube flush with the hole.

❑ 20. Look closely at the photo in step 19. You will find an elongated hole in the fuselage former. (Hole for choke.) Feed the choke tube through this hole. The tube should pass through the hole into the fuselage approximately 5" [127mm].

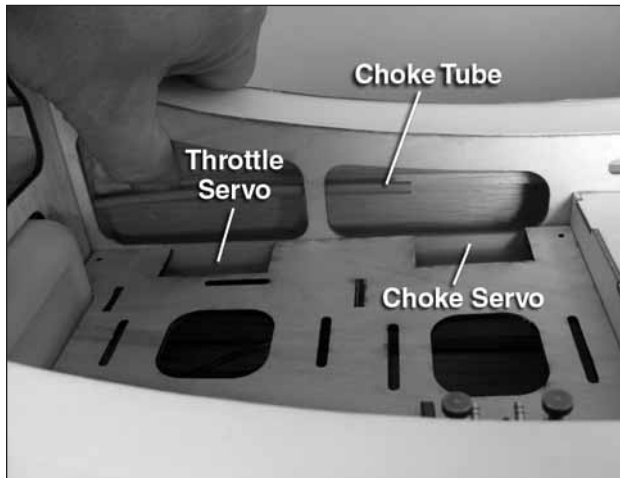

❑ 21. The forward opening is for the throttle servo. The aft opening is for the choke. The tube for the choke should be positioned as shown.



❑ 22. In the front of the fuselage, glue the plywood support for the choke tube to the former. Once the glue has cured cut off the portion of the plastic tube between the firewall and the plywood support as shown in the photo.



❑ 23. With the servo tray resting in place on the air tank, make a mark on the fuselage formers to show the location for the tray at each of the four corners of the tray.



❑ 24. 1/8" [3.2mm] below the marks you made make another line. Glue a 3/8" x 1/2" x 5/8" [9.5mm x 13mm 16mm] hardwood block so that the top of the block is aligned with the new line you just made. The tray will rest on and be screwed into the blocks. Once the glue has cured place the tray onto the blocks. Drill a 1/16" [1.6mm] hole through the holes in the corners of the tray into the blocks and then remove the tray.

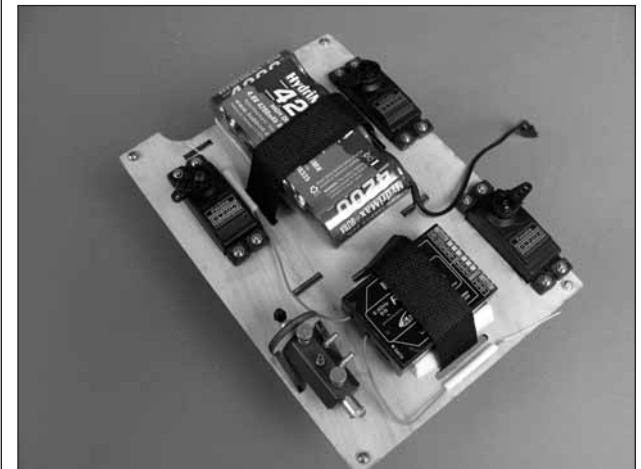

❑ 25. Install the battery and receiver to the tray. Insert a piece of R/C foam under each and secure them with Velcro® cut from the 12" [305mm] piece included in the kit. Using the same mounting method used for the other servos, install the throttle, choke and air control

valve servos to the tray as shown. Make single servo arms from 3/4" [19mm] servo arms. Enlarge the outer hole of the servo arm with a 5/64" [2mm] drill. Install an arm onto each of the servos.

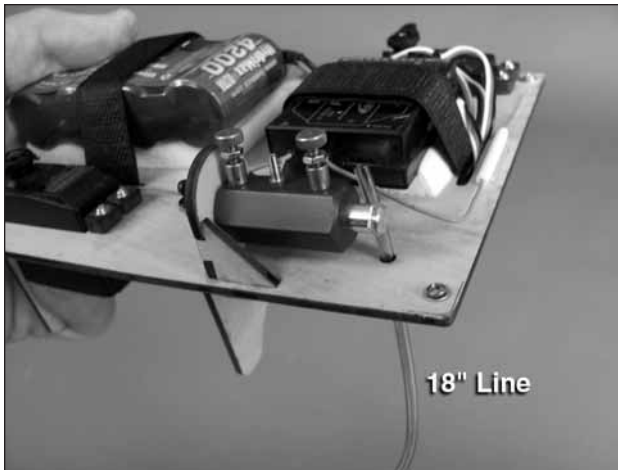

❑ 26. Feed the 18" [457mm] air line through the hole in the tray. The excess length of air line allows you to remove the tray and access the tank without disconnecting the air line from the air control valve when doing normal maintenance.



❑ 27. Determine where you would like to mount the air fill valve on your fuselage. Make a 5/16" [8mm] hole in the fuselage and then install the valve in the side of the fuselage. Install a "T" fitting in the air line between

the air tank and the air valve. Install an air line to the "T" fitting and the air control valve. If you are unfamiliar with the installation of the retractable landing gear air line system please refer to the instructions included with the air control kit.

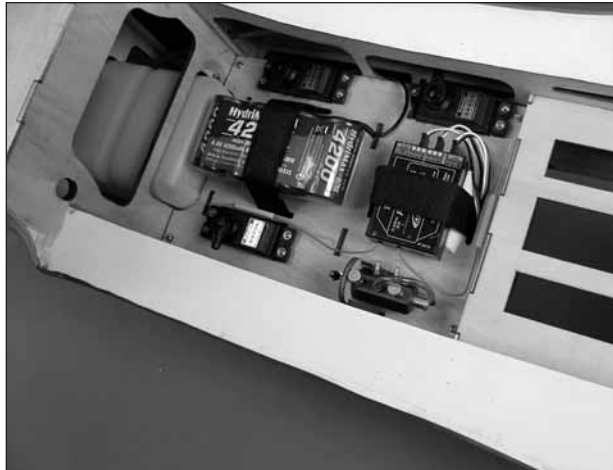

❑ 28. Place the tray onto the wood blocks. Secure the tray with four #2 x 3/8" [9.5mm] screws and flat washers, screwing them into the holes you drilled.



❑ 29. Install your radio switch and charge jack in the fuselage. Locate this switch as far away from the ignition switch and battery as is practical. It is generally recommended that you maintain 6"–10"

[254mm–152mm]. Make all of the connections between the switch harness and the radio.



❑ 30. Thread a nylon ball link onto one of the .074 x 6" [152mm] wires threaded on one end. Snap the ball link onto the ball on the air control valve. Center the servo and the air control valve. Make a mark on the wire when it is aligned with the outer hole in the servo arm. Make a 90 degree bend on the mark. Cut off the excess wire 3/8" [9.5mm] above the bend. Insert the wire into the outer hole of the servo arm. Install a Faslink™ onto the wire to secure it to the servo.



□ 31. From the 36" [914mm] flexible white nylon tube cut a 15" [381mm] and a 11" [279mm] length. Cut one half of the threads off of the threaded end of two .074 x 6" [152mm] wires. Thread the wires into each of the tubes. 1-1/4" [32mm] from the end of the tube make a 90 degree bend in the wire. Slide the 15" [381mm] nylon tube into the plastic tube you installed for the choke. Lock the wire to the servo with a nylon Faslink. Use a nylon tie wrap to secure the plastic outer tube to the fuselage as shown. Repeat this for the throttle. There is no need for the tie wrap for the throttle.

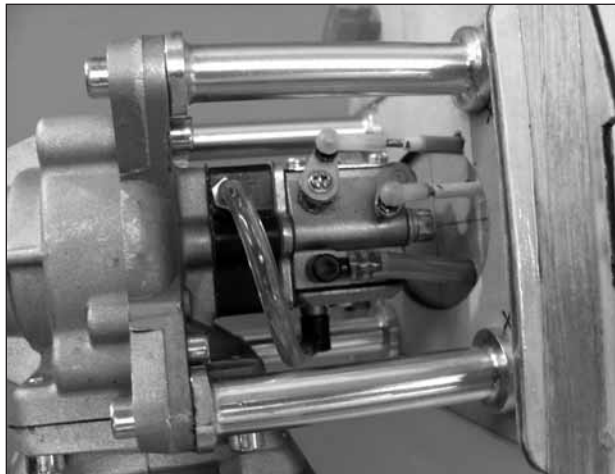
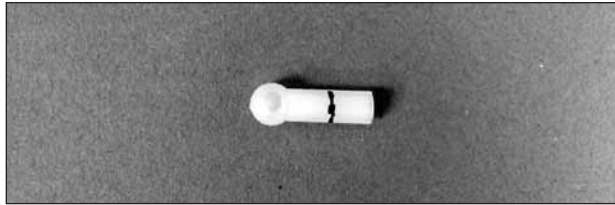

□ 32. If your engine is not already mounted to the stand-offs, install it now. Cut the threads off two more .074 x 6" [152mm] wires threaded on one end. Thread a nylon ball link on one. Cut another nylon ball link in half as shown and then thread it onto a threaded wire. Snap the full-length ball link onto the throttle on the engine and snap the short ball link onto the engine choke. Determine the final length that the white nylon rod needs to be to reach the throttle and choke. Cut off the excess length of the nylon tubes. Remove the ball links from the throttle and choke and then thread them into the tubes. Snap the ball links onto the balls on the throttle and choke. Slide the fuel line onto the carburetor fitting.

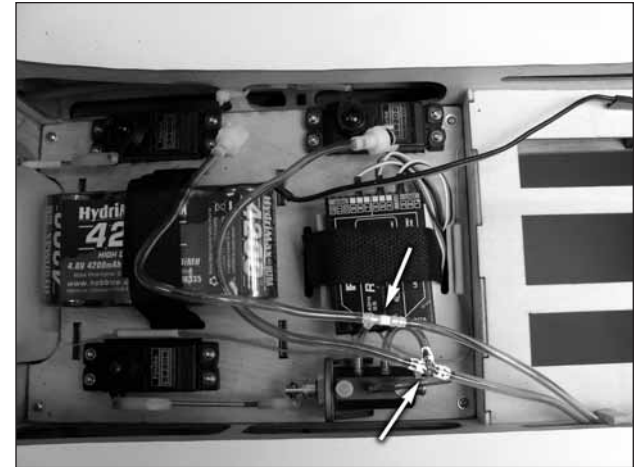

□ 33. Install a "T" fitting into each of the red and purple airlines from the tail wheel. Connect an 8" [203mm] length of red and purple air line to the end of the "T" fitting and the quick connect air line connectors. Finish the installation by installing a 2" [52mm] piece of red and purple air line between the "T" fittings and the fittings on the air control valve.



□ 34. Route the air lines from the tailwheel through the fuselage and secure them. We used some scraps of balsa to secure them to the fuselage as shown.

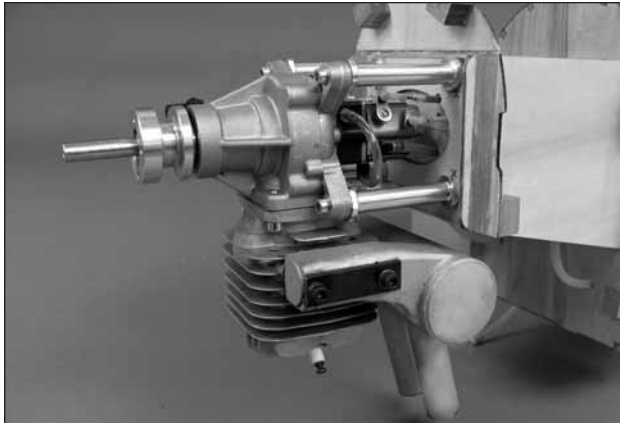

❑ 35. Mount your muffler of choice to the engine. We used the SlimLine™ Pitts style muffler. This muffler comes the closest to fitting in the cowl without making any cuts in the cowl.

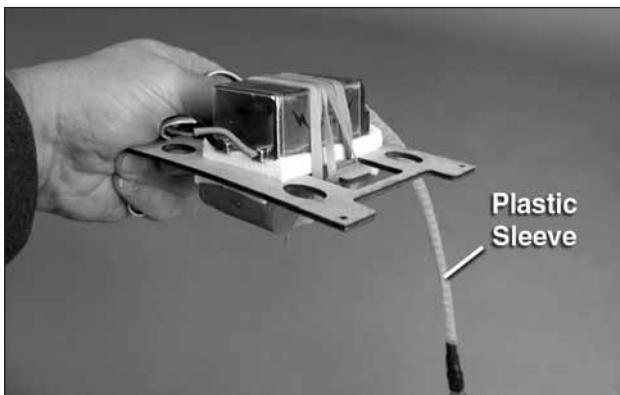
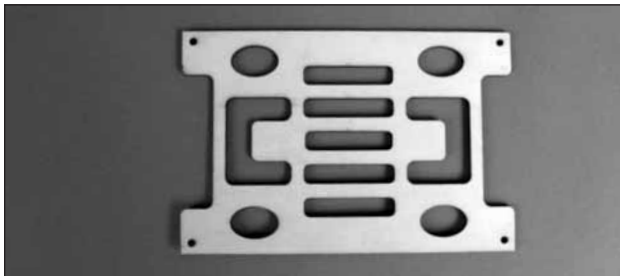

❑ 36. Locate the plywood ignition module / battery tray. Mount your ignition battery to the bottom of the tray and the ignition module to the top of the tray. Place a piece of foam between each of them. Secure them to

the tray with #64 rubber bands. Install the plastic sleeve with the engine over the spark plug wire.

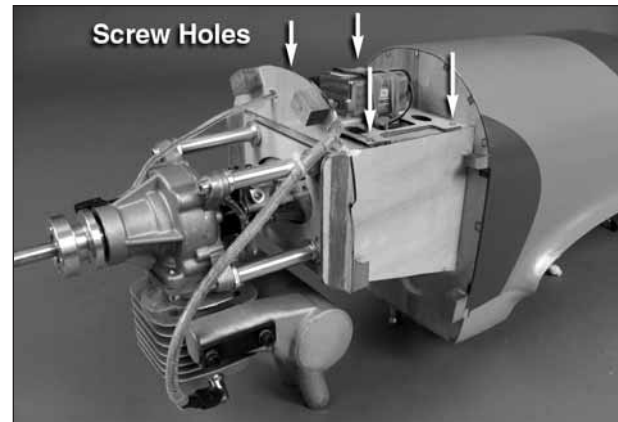

❑ 37. Place the tray on the top of the firewall box. Drill a 1/16" [1.6mm] hole through each of the mounting tabs into the plywood box. Secure the tray with four #2 x 3/8" [9.5mm] screws. If you have any concern about the screws vibrating loose you may wish to consider applying some silicone on the bottom of the tray. Should you need to remove the tray you can easily cut the silicone, freeing the tray.

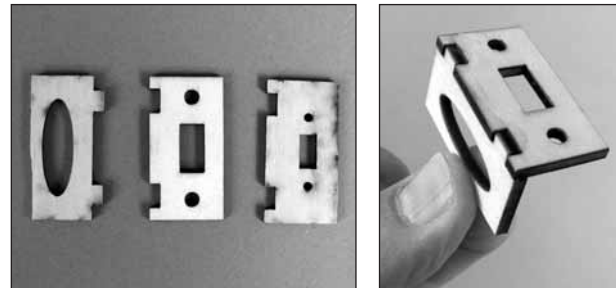

❑ 38. Locate the three plywood parts for the ignition switch mount. We have provided a pre-cut switch mount for either a standard switch or a heavy-duty switch. Determine which switch plate you will use and then glue it together as shown.



❑ 39. Mount the switch using just the screws that came with the switch. Glue the switch mount to the fuselage as shown in the picture in the next step.

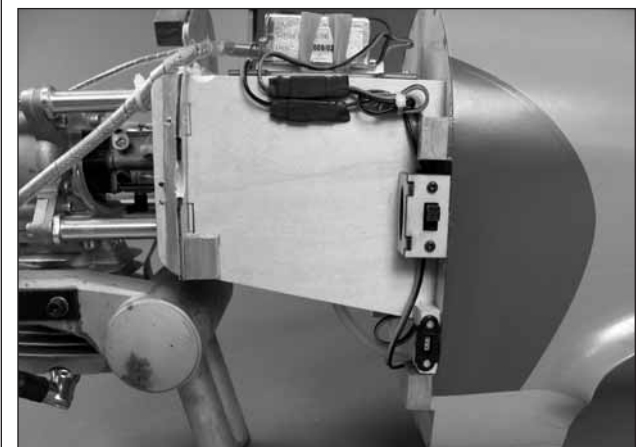
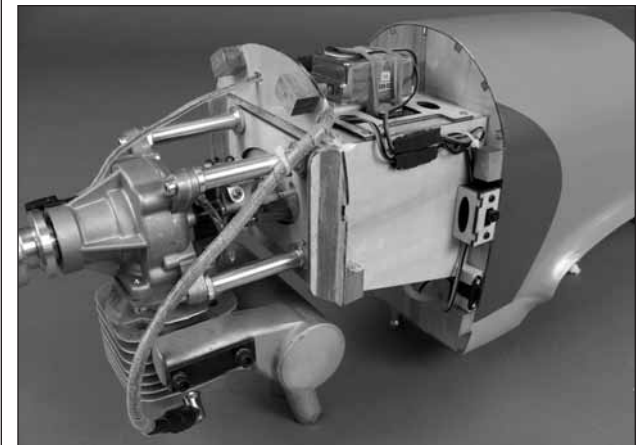

❑ 40. Make all of the connections for the ignition switch. Secure the connectors with heat shrink tubing,

tape or some other method for locking them together. We mounted the charge receptacle with the Earnst Charge Receptacle (ERNM3001). We mounted it between two $3/8" \times 3/8" \times 5/8"$ [10mm \times 10mm \times 15mm] hardwood blocks.

INSTALL THE COWL

The cowl installation is not difficult but will require you to work carefully and patiently to get a good fit. Take your time and you will have good results.

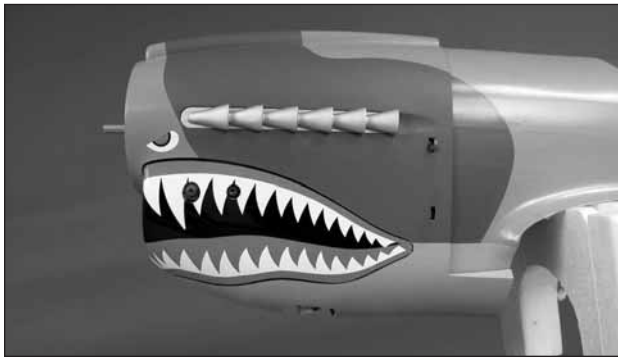

❑ 1. Slide the cowl over the engine and muffler. With a high-speed motor tool, make cutouts in the cowl to allow clearance for the switches, muffler bolts and muffler exhaust. Work slowly and make small cuts, enlarging them as you need to as the cowl gets into its final position. The engine installation we have shown here will only require clearance on the left side of the cowl. After you are satisfied with the cowl fit, remove the cowl from the airplane

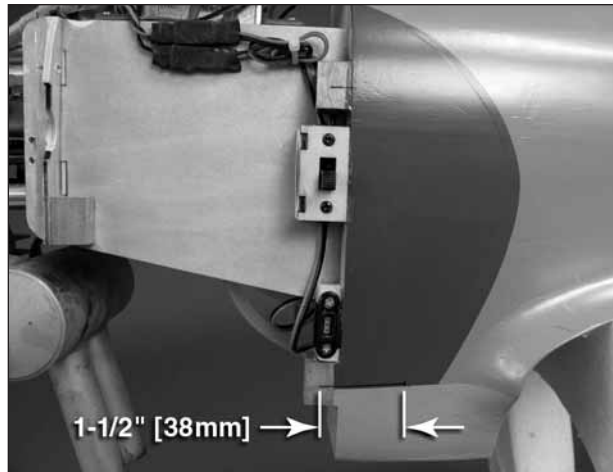
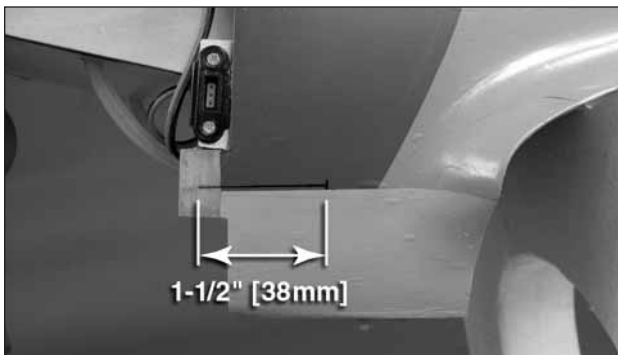

❑ 2. From the center of each of the cowl mounting blocks, draw a line back $1-1/2"$ [38mm] with a fine tip felt pen.

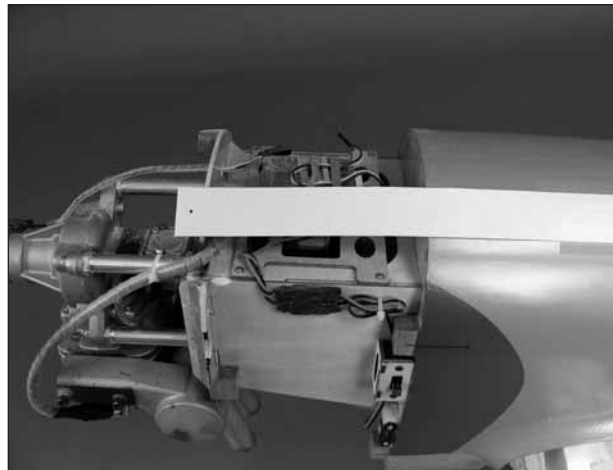

❑ 3. Cut a piece of card stock or paper $1" \times 9"$ [25mm \times 229mm]. Tape the paper to the top of the fuselage in line with the top mounting blocks. Make a mark on the piece of paper indicating the center of the block. Do this for both of the top cowl blocks.

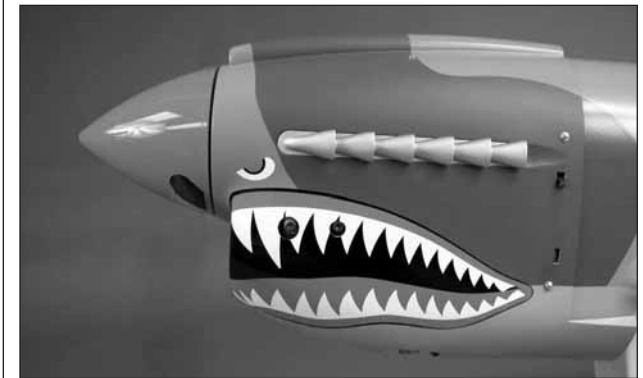
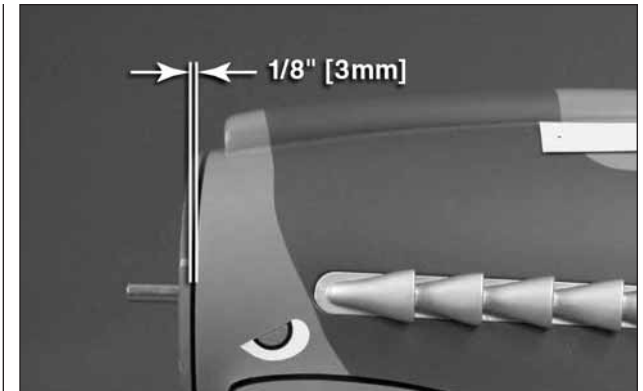

❑ 4. Place the cowl over the engine, making sure that the two paper references are on top of the cowl. Slide the spinner backplate onto the engine crankshaft. With the spinner tight against the engine thrust washer, position the cowl $1/8"$ [3mm] back from the back plate. Align the markings on the cowl with the markings on the fuselage. Using the lines you made as a reference, measure forward from the end of the line $1-1/2"$ [38mm] and make a mark. Starting on one side of the cowl, drill a $3/32"$ [2.4mm] hole through the cowl and into the mounting block. Install a $\#4 \times 1/2"$ [13mm] screw and $\#4$ flat washer into the hole to secure the cowl. Do this for all of the cowl mounting blocks. For the top two blocks use the paper reference to determine the drilling location. As you work your way around all of the blocks be sure to stop between each hole you drill and double check the positioning of the cowl making sure it is aligned with the spinner backplate and the reference lines on the fuselage.

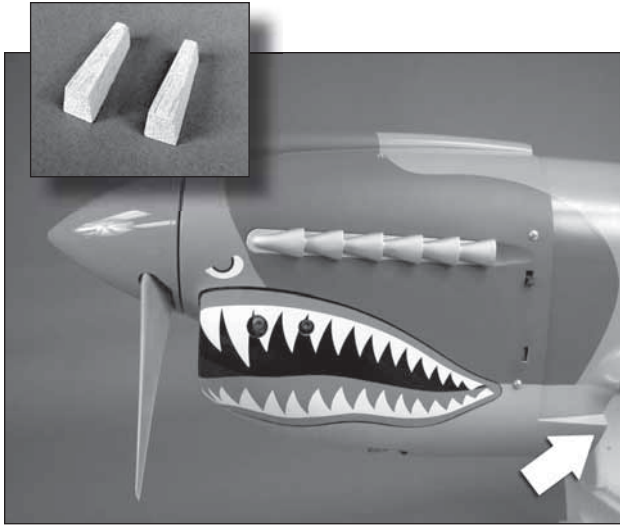

❑ 5. Be sure the cowl is installed before proceeding. Locate two angle cut blocks. Slide them between the cowl and the fuselage where shown. Look at the blocks to be sure they fit. If they don't, turn them over and re-insert them. Determine which side of each block will be glued to the fuselage. Remove the cowl.

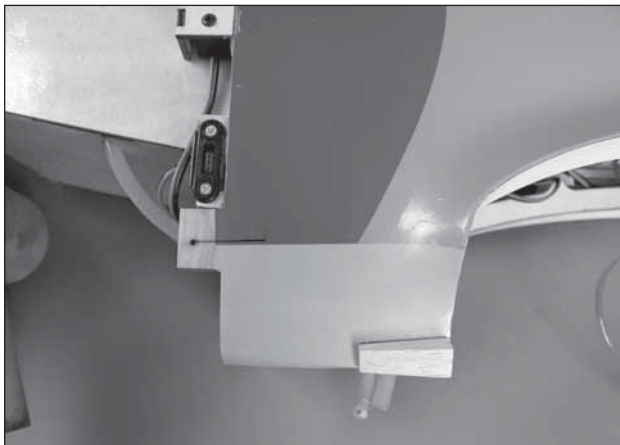

❑ 6. Place the block against the fuselage where shown. Mark the area and then cut the covering away from the fuselage using the same technique used for removing covering on the model in earlier steps. Glue the blocks in place on both sides of the fuselage. Fuel proof the blocks with paint or a light coat of thinned epoxy.

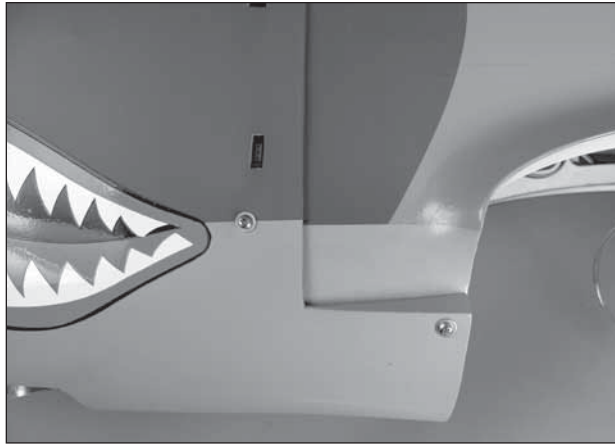

❑ 7. Re-install the cowl, securing it with all of the screws you installed in step 4. Drill a 3/32" [2.4mm] hole through the cowl and into the mounting block. Install a #4 x 1/2" [13mm] screw into the hole, securing the cowl. Do this for both blocks.

❑ 8. Install the prop to the engine. Install the spinner onto the backplate using the 5mm x 4" [102mm] spinner bolt.

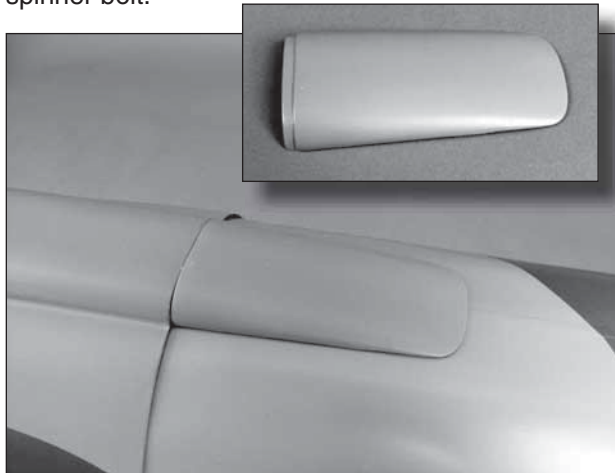

❑ 9. Locate the fiberglass cowl extension. Slide it in place under the cowl. Trace the outline of the extension onto the fuselage. Remove the extension. Cut the covering from the fuselage using the same technique described on page 16. Glue the extension in place on the fuselage.

INSTALL THE COCKPIT, PILOT AND CANOPY

We have provided a cockpit interior that, on its own, gives a very realistic look to the interior of the aircraft. With a little time and creative use of additional materials you can make a very detailed interior. Look through the following instructions to gain a better understanding of how the cockpit goes together. The installation shown here is for the basic cockpit interior. If you are going to add additional detail you may wish to make those additions before you assemble the interior. Added details can be created more easily before the cockpit is installed.

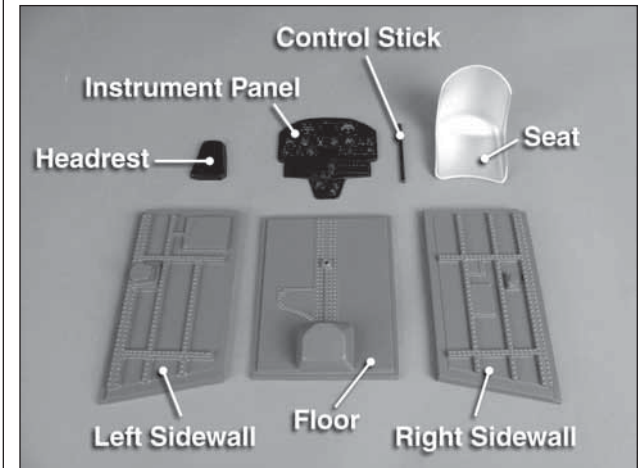

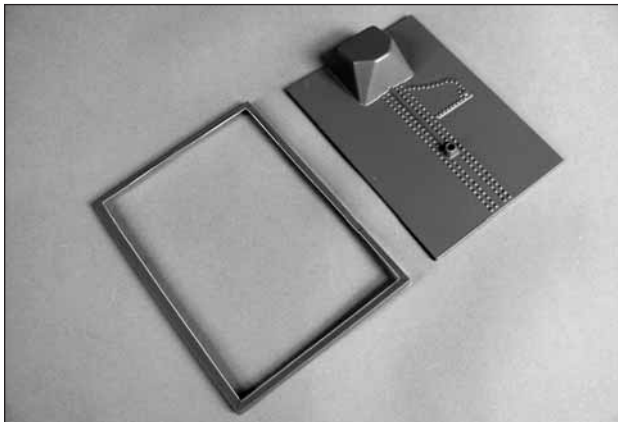
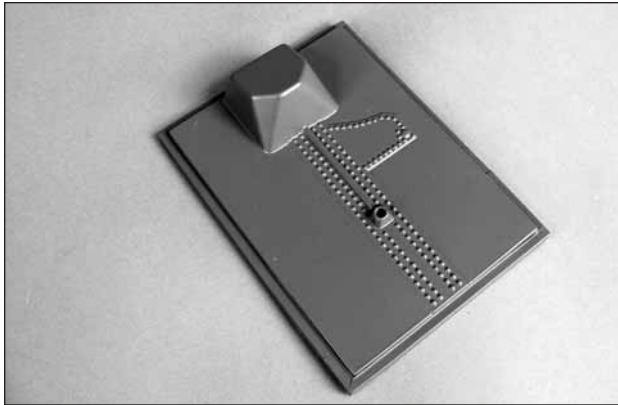

❑ 1. Cut the cockpit floor on the cut lines as shown. It is best to use a sharp hobby knife to do the cutting. Using a scissor can sometimes cause the plastic to crack at the corners.

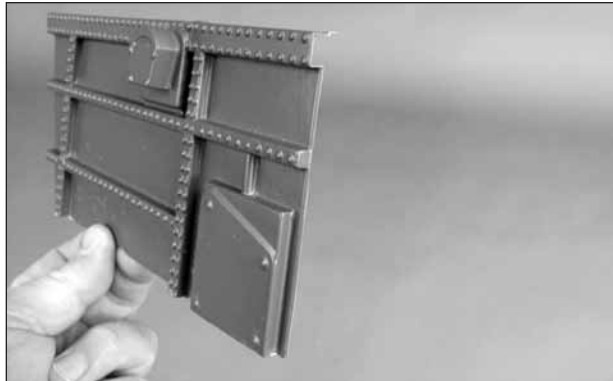
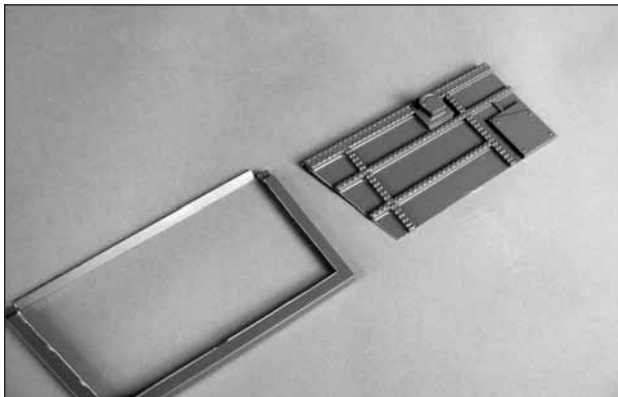

❑ 2. Cut the left and right sidewalls on the cut lines as shown.



❑ 3. Glue the cockpit floor into the fuselage followed by the two side walls. When the glue has dried glue the seat to the pedestal molded into the cockpit floor.



❑ 4. Install the two instrument panel decals to the panel. Complete the cockpit by gluing the instrument panel, control stick and headrest in place as shown.

❑ 5. A 1/5th scale pilot is correct for this model. If you will be installing a pilot, glue it in place now.

❑ 6. We installed the canopy using R/C Z 56. This flexible glue adheres well to MonoKote and dries completely clear. Glue the canopy to the fuselage Tape it in place until the glue has completely dried.

APPLY THE DECALS

Use the following instructions to apply the decals.

❑ 1. Use scissors or a sharp hobby knife to cut the decals from the sheet.

❑ 2. Be certain the model is clean and free from oily fingerprints and dust. Prepare a dishpan or small bucket with a mixture of liquid dish soap and warm water—about one teaspoon of soap per gallon of water. Submerge the decal in the soap and water and peel off the paper backing. **Note:** Even though the decals have a “sticky-back” and are not the water transfer type, submersing them in soap & water allows accurate positioning and reduces air bubbles underneath.

❑ 3. Position decal on the model where desired. Holding the decal down, use a paper towel to wipe most of the water away.

❑ 4. Use a piece of soft balsa or something similar to squeegee remaining water from under the decal. Apply the rest of the decals the same way.

Refer to these pictures and the pictures on the box to determine the location for the decals.

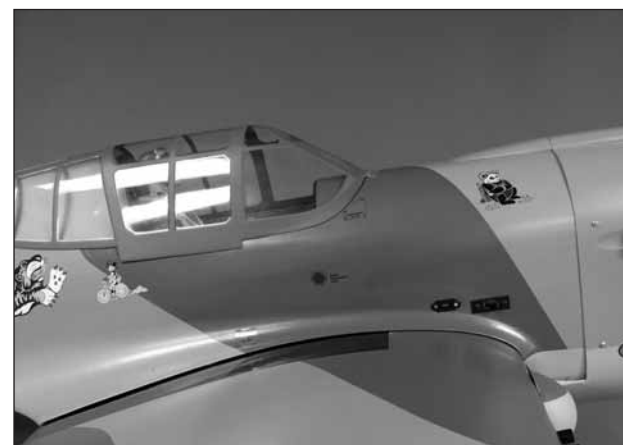
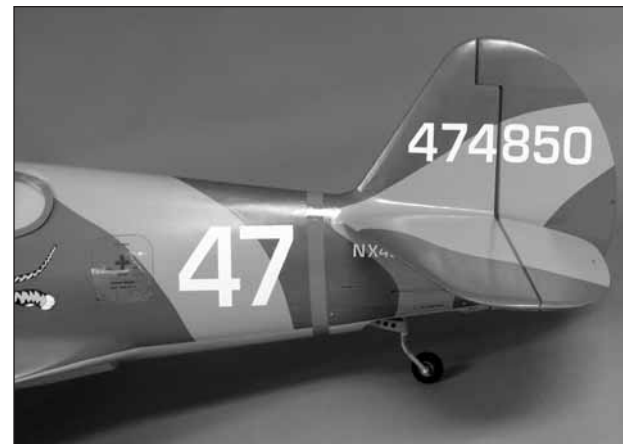
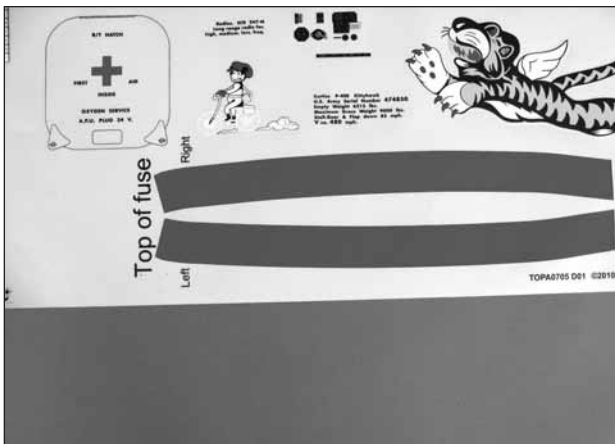

❑ 5. The red stripe around the back of the fuselage is applied in two pieces. The decal sheet clearly indicates which half to apply to each side of the fuselage. Be careful to apply the end of the stripe marked "Top of Fuselage", to the top of the fuselage.

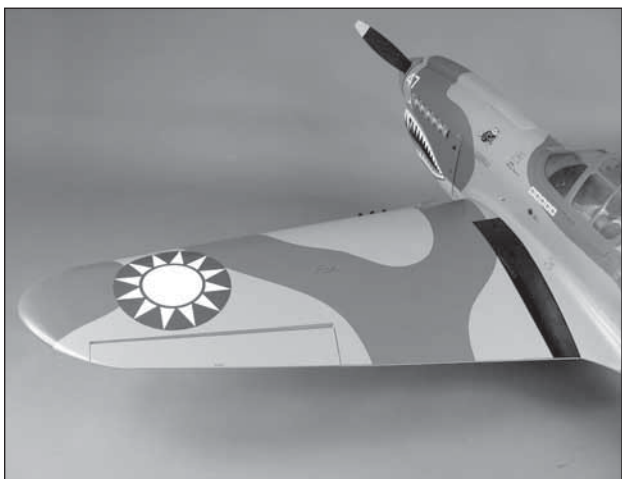

GET THE MODEL READY TO FLY

CHECK THE CONTROL DIRECTIONS

- ❑ 1. Turn on the transmitter and receiver and center the trims. If necessary, remove the servo arms from the servos and reposition them so they are centered. Reinstall the screws that hold on the servo arms.
- ❑ 2. With the transmitter and receiver still on, check all the control surfaces to see if they are centered. If necessary, adjust the clevises on the pushrods to center the control surfaces.

4-CHANNEL RADIO SETUP (STANDARD MODE 2)

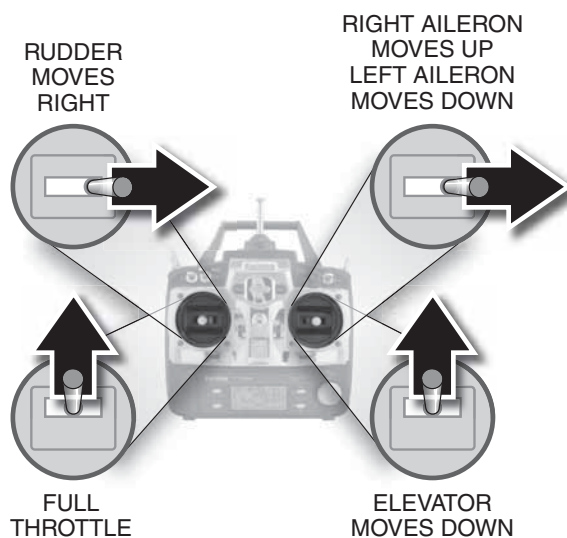

- ❑ 3. Make certain that the control surfaces and the carburetor respond in the correct direction as shown in the diagram. If any of the controls respond in the wrong direction, use the servo reversing in the transmitter to reverse the servos connected to those controls. Be certain the control surfaces have remained centered. Adjust if necessary.

SET THE CONTROL THROWS

To ensure a successful first flight, set up your P-40 according to the control throws specified in this manual. The throws have been determined through actual flight testing and accurate record-keeping allowing the model to perform in the manner in which it was intended. If, after you have become accustomed to the way the P-40 flies, you would like to change the throws to suit your taste, that is fine. However, too much control throw could make the model too responsive and difficult to control, so remember, "more is not always better."

- ❑ 1. Use a box or something similar to prop up the bottom of the fuselage so the horizontal stabilizer and wing will be level.

Measure the **high rate** elevator throw first...

- ❑ 2. Hold a ruler vertically on your workbench against the widest part (front to back) of the trailing edge of the elevator. Note the measurement on the ruler.



- ❑ 3. Move the elevator up with your transmitter and move the ruler forward so it will remain in contact with the trailing edge. The distance the elevator moves up from center is the "up" elevator throw. Measure the down elevator throw the same way.

- ❑ 4. If necessary, adjust the location of the pushrod on the servo arm or on the elevator horn, or program the ATVs in your transmitter to increase or decrease the throw according to the measurements in the control throws chart.

| These are the recommended control surface throws: | | | | |
|---|---------------|---------------|-------------|-------------|
| | HIGH RATE | | LOW RATE | |
| ELEVATOR | Up | Down | Up | Down |
| | 1" [25mm] | 1" [25mm] | 3/4" [19mm] | 3/4" [19mm] |
| | 13° | 13° | 10° | 10° |
| RUDDER | Right | Left | Right | Left |
| | 1-7/8" [48mm] | 1-7/8" [48mm] | 1" [25mm] | 1" [25mm] |
| | 18° | 18° | 9° | 9° |
| AILERONS | Up | Down | Up | Down |
| | 1" [25mm] | 1" [25mm] | 3/4" [19mm] | 3/4" [19mm] |
| | 18° | 18° | 13° | 13° |
| FLAPS | 2-1/2" [64mm] | | 36° | |

If your radio does not have dual rates, we recommend setting the throws at the high rate settings.

NOTE: The throws are measured at the **widest part** of the elevators, rudder and ailerons.

CHECK THE RETRACT OPERATION

- 1. Check the operation of the retractable landing gear. Be sure it is smooth, without any binding.
- 2. Adjust the rate that the gear moves up and down, following the instructions that came with the landing gear.

BALANCE THE MODEL (C.G.)

More than any other factor, the C.G. (center of gravity/ balance point) can have the greatest effect on how a model flies and could determine whether or not your first flight will be successful. If you value your model and wish to enjoy it for many flights, **DO NOT OVERLOOK THIS IMPORTANT PROCEDURE.** A model that is not properly balanced may be unstable and possibly unflyable.

At this stage the model should be in ready-to-fly condition with **all** of the components in place including the complete radio system, engine, muffler, propeller, spinner and pilot. The fuel tank should be empty.

- 1. If using a Great Planes C.G. Machine, set the rulers to 5.5" [140mm]. If not using a C.G. Machine, use a fine-point felt tip pen to mark lines on the top of wing on both sides of the fuselage 5.5" [140mm] back from the leading edge. Apply narrow (1/16" [1.6mm]) strips of tape over the lines so you will be able to feel them when lifting the model with your fingers.

This is where your model should balance for the first flights. Later, you may experiment by shifting the C.G. 5/16" [8mm] forward or 3/8" [9.5mm] back to change the flying characteristics. Moving the C.G. forward will improve the smoothness and stability, but the model will then be less aerobatic (which may be fine for less-experienced pilots). Moving the C.G. aft makes the model more maneuverable and aerobatic for experienced pilots. In any case, **start at the recommended balance point** and do not at any time balance the model outside the specified range.

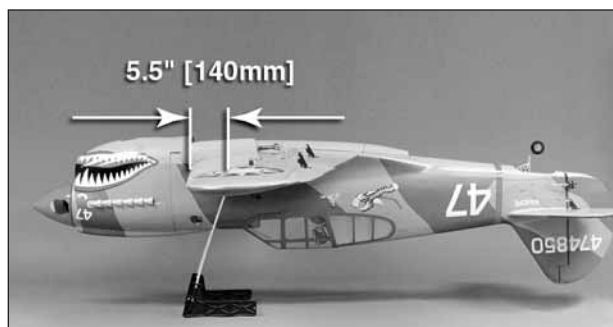

- 2. With the wing attached to the fuselage, all parts of the model installed (ready to fly) and an empty fuel tank, place the model upside-down on a Great Planes CG Machine, or lift it upside-down at the balance point you marked. The landing gear should be retracted into the wing when balancing the plane.

- 3. If the tail drops, the model is "tail heavy." If the nose drops, the model is "nose heavy." Use Great Planes "stick-on" lead (GPMQ4485) to balance the model. To find out how much weight is required, place incrementally increasing amounts of weight on the bottom of the fuselage over the location where it would be mounted inside until the model balances. A good place to add stick-on nose weight is to the firewall. Do not attach weight to the cowling—this will cause the mounting screws to open up the holes in the cowling. Once you have determined the amount of weight required, it can be permanently attached. If required, tail weight may be added by cutting open the bottom of the fuselage and gluing it permanently inside.

Note: If mounting weight were it may be exposed to fuel or exhaust, do not rely upon the adhesive on the back to permanently hold it in place. Over time, fuel and exhaust residue may soften the adhesive and cause the weight to fall off. Instead, permanently attach the weight with glue or screws.

- 4. **IMPORTANT:** If you found it necessary to add any weight, recheck the C.G. after the weight has been installed.

BALANCE THE MODEL Laterally

- 1. With the wing level, have an assistant help you lift the model by the engine propeller shaft and the bottom of the fuse under the TE of the fin. Do this several times.
- 2. If one wing always drops when you lift the model, it means that side is heavy. Balance the airplane by adding weight to the other wing tip. **An airplane that has been laterally balanced will track better in loops and other maneuvers.**

PREFLIGHT

IDENTIFY YOUR MODEL

No matter if you fly at an AMA sanctioned R/C club site or if you fly somewhere on your own, you should always have your name, address, telephone number and AMA number on or inside your model. It is **required** at all AMA R/C club flying sites and AMA sanctioned flying events. Fill out the identification tag on page 39 and place it on or inside your model.

CHARGE THE BATTERIES

Follow the battery charging instructions that came with your radio control system and ignition system to charge the batteries. You should always charge your transmitter and receiver batteries the night before you go flying, and at other times as recommended by the radio manufacturer.

CAUTION: Unless the instructions that came with your radio system state differently, the **initial** charge on **new** transmitter and receiver batteries should be done for 15 hours **using the slow-charger that came with the radio system.** This will “condition” the batteries so that the next charge may be done using the fast-charger of your choice. If the initial charge is done with a fast-charger the batteries may not reach their full capacity and you may be flying with batteries that are only partially charged.

BALANCE PROPELLERS

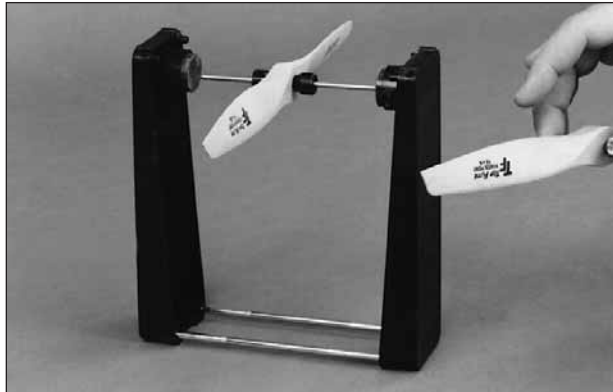

Carefully balance your propeller and spare propellers before you fly. An unbalanced prop can be the single most significant cause of vibration that can damage your model. Not only will engine mounting screws and bolts loosen, possibly with disastrous effect, but vibration may also damage your radio receiver and battery. Vibration can also cause your fuel to foam, which will, in turn, cause your engine to run hot or quit.

We use a Top Flite Precision Magnetic Prop Balancer™ (TOPQ5700) in the workshop and keep a Great Planes Fingertip Prop Balancer (GPMQ5000) in our flight box.

GROUND CHECK AND RANGE CHECK

Run the engine for a few minutes to make sure it idles reliably, transitions smoothly and maintains full power indefinitely. Afterward, shut the engine off and inspect the model closely, making sure all fasteners, pushrods and connections have remained tight and the hinges are secure. Always ground check the operational range of your radio before the first flight of the day following the manufacturer's instructions that came with your radio. This should be done once with the engine off and once with the engine running at various speeds. If the control surfaces do not respond correctly, **do not fly!** Find and correct the problem first. Look for loose servo connections or broken wires, corroded wires on old servo connectors, poor solder joints in your battery pack or a defective cell, or a damaged receiver crystal from a previous crash.

ENGINE SAFETY PRECAUTIONS

Failure to follow these safety precautions may result in severe injury to yourself and others.

Keep all engine fuel in a safe place, away from high heat, sparks or flames, as fuel is very flammable. Do not smoke near the engine or fuel; and remember that engine exhaust gives off a great deal of deadly carbon monoxide. Therefore **do not run the engine in a closed room or garage.**

Get help from an experienced pilot when learning to operate engines.

Use safety glasses when starting or running engines.

Do not run the engine in an area of loose gravel or sand; the propeller may throw such material in your face or eyes.

Keep your face and body as well as all spectators away from the plane of rotation of the propeller as you start and run the engine.

Keep these items away from the prop: loose clothing, shirt sleeves, ties, scarfs, long hair or loose objects such as pencils or screwdrivers that may fall out of shirt or jacket pockets into the prop.

Use a “chicken stick” or electric starter to start the engine. Do not use your fingers to flip the propeller. Make certain the glow plug clip or connector is secure so that it will not pop off or otherwise get into the running propeller.

Make all engine adjustments from behind the rotating propeller.

The engine gets hot! Do not touch it during or right after operation. Make sure fuel lines are in good condition so fuel will not leak onto a hot engine, causing a fire.

To stop a gasoline powered engine an on/off switch should be connected to the engine coil. Do not throw anything into the propeller of a running engine.

AMA SAFETY CODE (excerpts)

Read and abide by the following excerpts from the Academy of Model Aeronautics Safety Code. For the complete Safety Code refer to *Model Aviation* magazine, the AMA Web site or the Code that came with your AMA license.

GENERAL

1) I will not fly my model aircraft in sanctioned events, air shows, or model flying demonstrations until it has been proven to be airworthy by having been previously, successfully flight tested.

2) I will not fly my model aircraft higher than approximately 400 feet within 3 miles of an airport without notifying the airport operator. I will give right-of-way and avoid flying in the proximity of full-scale aircraft. Where necessary, an observer shall be utilized to supervise flying to avoid having models fly in the proximity of full-scale aircraft.

3) Where established, I will abide by the safety rules for the flying site I use, and I will not willfully and deliberately fly my models in a careless, reckless and/or dangerous manner.

5) I will not fly my model unless it is identified with my name and address or AMA number, on or in the model. Note: This does not apply to models while being flown indoors.

7) I will not operate models with pyrotechnics (any device that explodes, burns, or propels a projectile of any kind).

RADIO CONTROL

1) I will have completed a successful radio equipment ground check before the first flight of a new or repaired model.

2) I will not fly my model aircraft in the presence of spectators until I become a qualified flier, unless assisted by an experienced helper.

3) At all flying sites a straight or curved line(s) must be established in front of which all flying takes place with the other side for spectators. Only personnel involved with flying the aircraft are allowed at or in the front of the flight line. Intentional flying behind the flight line is prohibited.

4) I will operate my model using only radio control frequencies currently allowed by the Federal Communications Commission.

5) **I will not knowingly operate my model within three miles of any pre-existing flying site except in accordance with the frequency sharing agreement listed** [in the complete AMA Safety Code].

9) Under no circumstances may a pilot or other person touch a powered model in flight; **nor should any part of the model other than the landing gear, intentionally touch the ground, except while landing.**

CHECK LIST

During the last few moments of preparation your mind may be elsewhere anticipating the excitement of the first flight. Because of this, you may be more likely to overlook certain checks and procedures that should be performed before the model is flown. To help avoid this, a check list is provided to make sure these important areas are not overlooked. Many are covered in the instruction manual, so where appropriate, refer to the manual for complete instructions. Be sure to check the items off as they are completed (that's why it's called a *check list!*).

1. Fuelproof all areas exposed to fuel or exhaust residue such as the cowl ring, cowl mounting blocks, wing saddle area, etc.

2. Check the C.G. according to the measurements provided in the manual.

3. Be certain the battery and receiver are securely mounted in the fuselage. Simply stuffing them into place with foam rubber is not sufficient.

4. Extend your receiver antenna and make sure it has a strain relief inside the fuselage to keep tension off the solder joint inside the receiver.

5. Balance your model *laterally* as explained in the instructions.

6. Use threadlocking compound to secure critical fasteners such as the set screws that hold the wheel axles to the struts, screws that hold the carburetor arm (if applicable), screw-lock pushrod connectors, etc.

7. Add a drop of oil to the axles so the wheels will turn freely.

8. Make sure all hinges are **securely** glued in place.

9. Reinforce holes for wood screws with thin CA where appropriate (servo mounting screws, cowl mounting screws, etc.).

10. Confirm that all controls operate in the correct direction and the throws are set up according to the manual.

11. Make sure there are silicone retainers on all the clevises and that all servo arms are secured to the servos with the screws included with your radio.

12. Secure connections between servo wires and Y-connectors or servo extensions, and the connection between your battery pack and the on/off switch with vinyl tape, heat shrink tubing or special clips suitable for that purpose.

13. Make sure any servo extension cords you may have used do not interfere with other systems (servo arms, pushrods, etc.).

14. Secure the pressure tap (if used) to the muffler with high temp RTV silicone, thread locking compound or J.B. Weld.

15. Make sure the fuel lines are connected and are not kinked.

16. Balance your propeller (and spare propellers).

- 17. Tighten the propeller nut and spinner.
- 18. Place your name, address, AMA number and telephone number on or inside your model.
- 19. Cycle your receiver battery pack (if necessary) and make sure it is fully charged.
- 20. If you wish to photograph your model, do so before your first flight.
- 21. Range check your radio when you get to the flying field.
- 22. Be sure to fill the air tank.

FLYING

The P-40 does not possess the self-recovery characteristics of a primary R/C trainer and should be flown only by experienced R/C pilots.

FUEL MIXTURE ADJUSTMENTS

A fully cowled engine may run at a higher temperature than an un-cowled engine. For this reason, the fuel mixture should be richened so the engine runs at about 200 rpm below peak speed. By running the engine slightly rich, you will help prevent dead-stick landings caused by overheating.

CAUTION (THIS APPLIES TO ALL R/C AIRPLANES): If, while flying, you notice an alarming or unusual sound such as a low-pitched “buzz,” this may indicate control surface *flutter*. Flutter occurs when a control surface (such as an aileron or elevator) or a flying surface (such as a wing or stab) rapidly vibrates up and down (thus causing the noise). In extreme cases, if not detected immediately, flutter can actually cause the control surface to detach or the flying surface to fail, thus causing loss of control followed by an impending crash. The best thing to do when flutter is detected is to slow the model **immediately** by reducing power, then land as soon as safely possible. Identify which surface fluttered (so the problem may be resolved) by checking all the servo grommets for deterioration or signs of vibration. Make certain all pushrod linkages are secure and free of play. If it fluttered once, under similar circumstances it will probably flutter again unless the problem is fixed. Some things which can cause flutter are; Excessive hinge gap; Not mounting control horns solidly; Poor fit of clevis pin in horn; Side-play of wire pushrods caused by large bends; Excessive free play in servo gears; Insecure servo mounting; and one of the most prevalent causes of flutter; Flying an over-powered model at excessive speeds.

TAKEOFF

Before you get ready to take off, see how the model handles on the ground by doing a few practice runs at **low speeds** on the runway. Hold “up” elevator to keep the tail wheel on the ground. If necessary, adjust the tail wheel so the model will roll straight down the runway. If you need to calm your nerves before the maiden flight, shut the engine down and bring the model back into the pits. Top off the fuel, then check all fasteners and control linkages for peace of mind.

The P-40 has a narrow landing gear stance. Sometimes this can make ground handling a little tricky. Taking off directly into the wind makes ground handling relatively easy. We would recommend that whenever possible you take off and land into the wind. Taking off in a cross wind or landing cross wind you will need to be quick on

the rudder and may need to use ailerons to help keep the wing level during the take off or landing roll out.

When you’re ready, point the model straight down the runway, hold a bit of up elevator to keep the tail on the ground to maintain tail wheel steering, then gradually advance the throttle. As the model gains speed decrease up elevator allowing the tail to come off the ground. One of the most important things to remember with a tail dragger is to always be ready to apply **right** rudder to counteract engine torque. Gain as much speed as your runway and flying site will practically allow before gently applying up elevator, lifting the model into the air. At this moment it is likely that you will need to apply more right rudder to counteract engine torque. Be smooth on the elevator stick, allowing the model to establish a **gentle** climb to a safe altitude before turning into the traffic pattern.

FLIGHT

For reassurance and to keep an eye on other traffic, it is a good idea to have an assistant on the flight line with you. Tell him to remind you to throttle back once the plane gets to a comfortable altitude. While full throttle is usually desirable for takeoff, most models fly more smoothly at reduced speeds.

Take it easy with the P-40 for the first few flights, gradually getting acquainted with it as you gain confidence. Adjust the trims to maintain straight and level flight. After flying around for a while, and while still at a safe altitude with plenty of fuel, practice slow flight and execute practice landing approaches by reducing the throttle to see how the model handles at slower speeds. Add power to see how she climbs as well. Continue to fly around, executing various maneuvers and making mental notes (or having your assistant write them down) of what trim or C.G. changes may be required to fine tune the model so it flies the way you like. Mind your fuel level, but use this first flight to become familiar with your model before landing.

The P-40 is a very solid flying airplane. It will perform all of the typical maneuvers a WWII fighter was capable of. Loops, rolls and hammerheads are performed as

you would expect. With the landing gear retracted, there is nothing more impressive than a high speed fly by to show off the airplane to all of those watching. The airplane has a wide flight envelope. When the landing gear is retracted and the throttle fully open the airplane is fast. With the flaps deployed the airplane flies very slow, yet remains stable. When you deploy the flaps, expect it to balloon a bit. It is not severe but watch for it. We found that if you mix in 2 degrees of down elevator when the flaps are fully deployed that the ballooning was eliminated. We recommend you spend some time flying with the flaps deployed, flying at slower speeds.

LANDING

To initiate a landing approach, lower the throttle while on the downwind leg. Allow the nose of the model to pitch downward to gradually bleed off altitude. Continue to lose altitude, but maintain airspeed by keeping the nose down as you turn onto the crosswind leg. In the crosswind leg deploy the flaps. Make your final turn toward the runway (into the wind) keeping the nose down to maintain airspeed and control. Level the attitude when the model reaches the runway threshold, modulating the throttle as necessary to maintain your glide path and airspeed. If you are going to overshoot, smoothly advance the throttle (always ready on the right rudder to counteract torque) and climb out to make another attempt. When you're ready to make your landing flare and the model is a foot or so off the deck, smoothly increase up elevator until it gently touches down. Once the model is on the runway and has lost flying speed, hold up elevator to place the tail on the ground, regaining tail wheel control.

If you are not accustomed to an airplane with flaps, you will discover that landings are slightly different. A typical model without flaps will generally initiate a landing approach with a gradual reduction in altitude so that on the final approach you will be at a fairly low altitude and will drive the airplane to the runway. The P-40 lands best if you make your final approach at about 100 feet (30 meters) as you approach the end of the runway. Gradually reduce your speed, point the nose towards the end of the runway maintaining a steady

descent. Level the airplane about three feet (1 meter) above the runway and allow the plane to touch down on the main gear and roll out until the tail naturally settles onto the runway.

One final note about flying your model. Have a goal or flight plan in mind for **every** flight. This can be learning a new maneuver(s), improving a maneuver(s) you already know, or learning how the model behaves in certain conditions (such as on high or low rates). This is not necessarily to improve your skills (*though it is never a bad idea!*), but more importantly so you do not surprise yourself by impulsively attempting a maneuver and suddenly finding that you've run out of time, altitude or airspeed. Every maneuver should be deliberate, not impulsive. For example, if you're going to do a loop, check your altitude, mind the wind direction (anticipating rudder corrections that will be required to maintain heading), remember to throttle back at the top, and make certain you are on the desired rates (high/

low rates). A flight plan greatly reduces the chances of crashing your model just because of poor planning and impulsive moves. **Remember to think.**

Have a ball! But always stay in control and fly in a safe manner.

GOOD LUCK AND GREAT FLYING!

| | |
|------------------------|---------|
| This model belongs to: | _____ |
| | Name |
| | _____ |
| | Address |
| | _____ |
| City, State, Zip | |
| _____ | |
| Phone Number | |
| _____ | |
| AMA Number | |



