



To see our entire product line including spare parts, go to www.revell.com/spindrive



Loop Set

Safety Precautions:

Warning: Do not modify or alter this unit. Changes or modifications to this unit not expressly approved by the party responsible for compliance could void the user's authority to operate the equipment.

- Keep hands, hair and loose clothing away from the moving parts.
 - Parental guidance is recommended.
 - Keep these instructions for future reference.
 - Follow the operating instructions exactly.
- Care and Maintenance:**
- Wipe the track gently with a clean, damp cloth.
 - Keep the set away from direct heat.
 - Do not submerge the set into water. This could damage the electronic assemblies.

Note Specifically for Adults:

- Regularly examine all parts of the set for damage. If any is found, do not use the toy again until the damage has been repaired.
- This set is not intended for children under 8 years old.

LOOP ASSEMBLY

NOTE: Use the drawing on other side for reference.

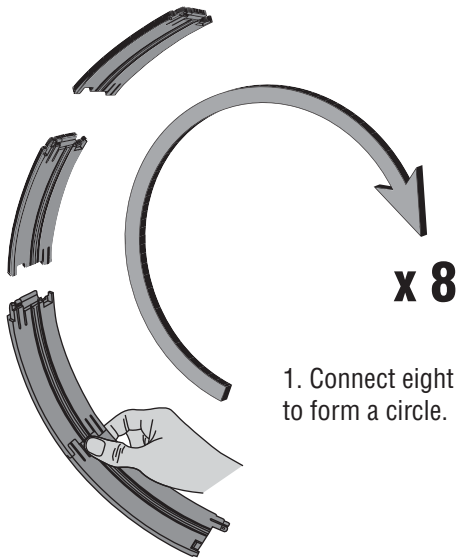

1. Connect eight loop track sections to form a circle.

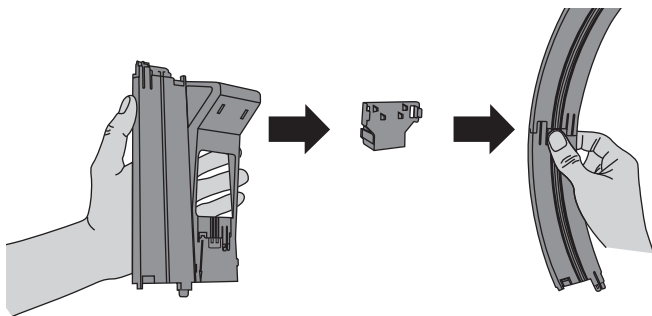

2. Mount one end of the circle to the female connector on the "A" loop base and the other to the male connector on the "B" loop base. Secure the loop to the loop base using the loop supports.

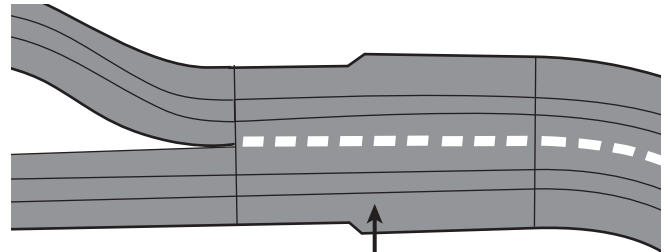

LOOP ADAPTER TRACK

3. Note the orientation of the loop adapter tracks that connect the single lanes to the double track.

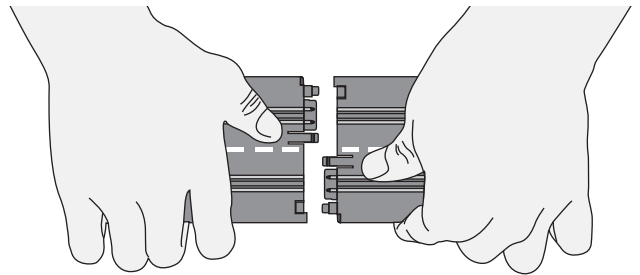

TIP! Connect by inserting the pins on one section of track into matching holes on the next. To disconnect, push down the two locking tabs and pull apart.

WARNING:
CHOKING HAZARD
— Small parts.
Not for children under 3 years of age.



"This product is in compliance with the essential requirements and other relevant provisions of Directive 1999/5/EC."



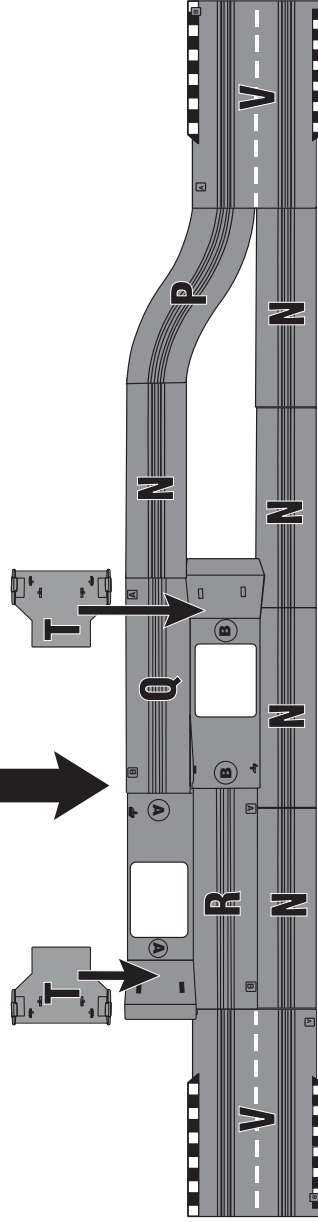
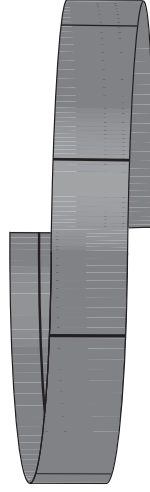
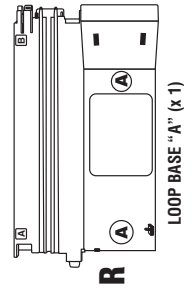
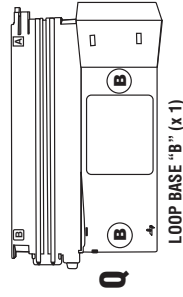
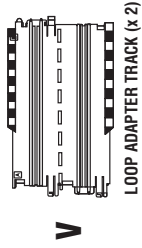
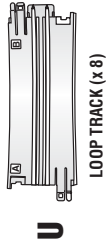
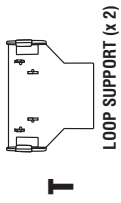

In the event your SPIN DRIVE Slot Car Set requires repairs or replacement, **please do not return product to the place of purchase.**

Our Hobby Services department is always happy to help you. All it takes is a single toll-free phone call!

Please contact us at:

1-866-HOBBICO (462-2426)

9 a.m.-5 p.m. Central, Mon.-Fri.

Hobby Services

3002 N. Apollo Drive, Suite 1

Champaign, IL 61822

Attn: Service Department