

VUSION

HOUSERACER



RISE™
explore-rise.com

INSTRUCTION MANUAL

WARNING

Please read and understand this manual, the operation and all safety aspects required for the safe operation of the product. Before use, if you feel that this product is not for you, please return it to the place of purchase.

Manual Specifications and Description Changes

The instruction manual, warranties, and other associated documentation are subject to change without notice. Hobbico assumes no responsibility for inadvertent errors to this manual.

INTRODUCTION

Thank you for purchasing the VUSION HOUSE RACER. We want the time you spend with your new R/C quadcopter to be fun and successful so please read the entire manual before beginning setup. If for any reason you think this R/C model is not for you, return it to the dealer immediately. Your dealer cannot accept returns on any model after final assembly.

For the latest technical updates or manual corrections for the VUSION HOUSE RACER please visit the RISE web site at www.explore-rise.com. If there is any new technical information, changes or important updates to this model a “tech notice” box will appear on the page. Click the “tech notice” box to learn more.

SAFETY PRECAUTIONS



Failure to follow these safety precautions may result in injury to yourself and others.

- Keep your face and body as well as all spectators away from the rotating plane of the blades whenever the battery is connected. Keep loose clothing, shirt sleeves, ties, scarfs, long hair or loose objects such as pencils or screwdrivers that may fall out of shirt or jacket pockets away from the rotors. The spinning blades of a model quadcopter can cause serious injury. When choosing a flying site for your VUSION HOUSE RACER, stay clear of obstacles, trees and power lines. **AVOID** flying in or near crowded areas. **DO NOT** fly close to people or pets. Maintain a safe distance from the quadcopter.
- Your VUSION HOUSE RACER should not be considered a toy. Because of its performance capabilities, the VUSION HOUSE RACER, if not operated correctly, could cause injury to you or spectators and damage to property.
- **DO NOT** alter or modify the model. Doing so may result in an unsafe or unflyable model.
- When and if repairs are necessary you must correctly install all components so that the model operates properly on the ground and in the air. Please check the operation of the model before every flight to insure that all equipment is operating and that the model has remained structurally sound. Be sure to check the propellers before each flight. Replace them if they show any signs of wear or fatigue.

KNOW BEFORE YOU FLY

As a new owner of an unmanned aircraft system (UAS), you are responsible for the operation of this vehicle and the safety of those around you. Please contact your local authorities to find out the latest rules and regulations.



Federal Aviation Administration
faa.gov/uas

FCC License

Operation of the VUSION HOUSE RACER does not require that the pilot have a Technician's license (HAM) from the FCC. If you would like more information, please visit the following link.

http://wireless.fcc.gov/services/index.htm?job=licensing_2&id=amateur

AMA

We urge you to join the AMA (Academy of Model Aeronautics) and a local R/C club. The AMA is the governing body of model aviation and membership is required to fly at AMA clubs. Though joining the AMA provides many benefits, one of the primary reasons to join is liability protection. Coverage is not limited to flying at contests or on the club field. It even applies to flying at public demonstrations and air shows. Failure to comply with the Safety Code may endanger insurance coverage. Additionally, training programs and instructors are available at AMA club sites to help you get started the right way. There are over 2,500 AMA chartered clubs across the country. Contact the AMA at the address or toll-free phone number that follows.



Academy of Model Aeronautics
5151 East Memorial Drive
Muncie, IN 47302-9252

Tele. (800) 435-9262
Fax (765) 741-0057

Or via the Internet at: www.modelaircraft.org

IMPORTANT: Two of the most important things you can do to preserve the radio controlled aircraft hobby are to avoid flying near full-scale aircraft and avoid flying near or over groups of people.

BATTERY WARNINGS

- **ALWAYS** unplug your battery from either the charger or quadcopter after use. **NEVER** store your quadcopter with the battery plugged into the quadcopter.
- **DO NOT** attempt to charge your battery if it becomes swollen or hot.
- It is best to store your batteries in a cool, dry location at 1/2 charge (3.8V). Storing a fully discharged battery may cause irreversible damage to the battery.
- **NEVER** disassemble, puncture or modify the battery pack in any way.
- **NEVER** allow the battery temperature to exceed 150° F [65° C].
- If your battery begins to swell or "puff" during charge or discharge or becomes damaged in any way, stop using it.

WARRANTY

RISE™ guarantees this kit to be free from defects in both material and workmanship at the date of purchase. This warranty does not cover any component parts damaged by use or modification. In no case shall RISE's liability exceed the

original cost of the purchased kit. Further, RISE reserves the right to change or modify this warranty without notice. In that RISE has no control over the final assembly or material used for final assembly, no liability shall be assumed nor accepted for any damage resulting from the use by the user of the final user-assembled product. By the act of using the user assembled product, the user accepts all resulting liability. If the buyer is not prepared to accept the liability associated with the use of this product, the buyer is advised to return this kit immediately in new and unused condition to the place of purchase.

To make a warranty claim, send the defective part or item to Hobby Services at this address.

Hobby Services

3002 N. Apollo Dr., Suite 1
Champaign, IL 61822 USA

217-398-8970 ext#6

productsupport@hobbyservices.com

Include a letter stating your name, return shipping address, as much contact information as possible (daytime telephone number, fax number, e-mail address), a detailed description of the problem and a photocopy of the purchase receipt. Upon receipt of the package the problem will be evaluated as quickly as possible.

CONTENTS

FPV RTF Version (RISE0207)

- RISE Vusion House Racer Quadcopter
- 2.4GHz 6-Channel Transmitter
- Extra Props
- FPV Goggle with Monitor
- Monitor Antenna
- Goggle Foam Liner
- 650mAh 1S LiPo
- USB LiPo Charger
- USB Charge Cable for the Monitor
- Wall Guards
- Screwdriver
- Instruction Manual

FPV-R Version (RISE0208)

- RISE Vusion House Racer Quadcopter
- 650mAh 1S LiPo
- USB LiPo Charger
- Extra Props
- Wall Guards
- Instruction Manual



FEATURES

- Entry Level 120 class indoor racing quad
- Ready to Fly, no building required
- Wall Guards to increase stability
- Flip Button
- Flight Controller is pre-programmed with two stability modes and a rate mode
- 600TVL FPV Camera
- 25mW VTX

DIMENSIONS

Size: 120 mm (4.7 in) diagonally motor to motor

Width: 165 mm (6.5 in)

Length: 165 mm (6.5 in)

Height: 52 mm (2.0 in)

Prop: 58 mm (2.3 in)

Empty Weight: 51.7g (1.82 oz.) without battery

SETUP

The VUSION HOUSE RACER is completely assembled. If you have the FPV RTF version, please read the manual for the FPV monitor before setting up and flying the House Racer.

Battery Charging

Plug charger into USB port or AC adapter (DIDP1125 not included) as shown and connect the battery. The red LED will flash slowly while the battery is charging. The LED will be steady when the battery is fully charged.

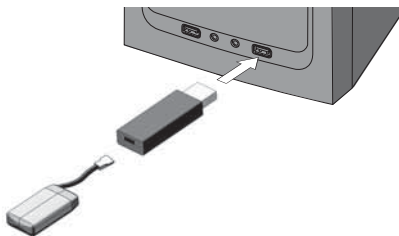

- **NEVER** leave the battery unattended while charging.
- **DO NOT** allow the USB port to power down while the charger is connected to the battery.
- **ALWAYS** unplug the charger from the USB port and the battery when charging is complete.
- The battery connector will only fit in one way.
- For best results use a USB source that is 1 amp or greater.

Battery Installation

Slide the battery into the battery tray on the bottom of the frame.

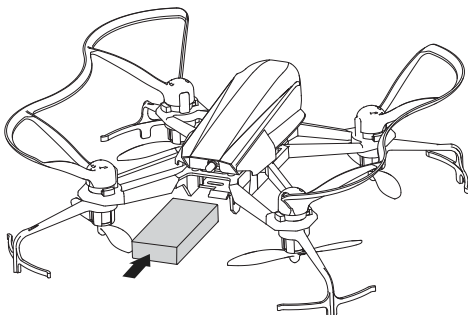

Wall Guard Installation

The House Racer has wall guards to help prevent it from flipping over when it makes contact with other objects. To install, push them onto the tops of the motors.

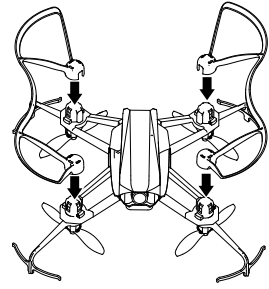

Radio System

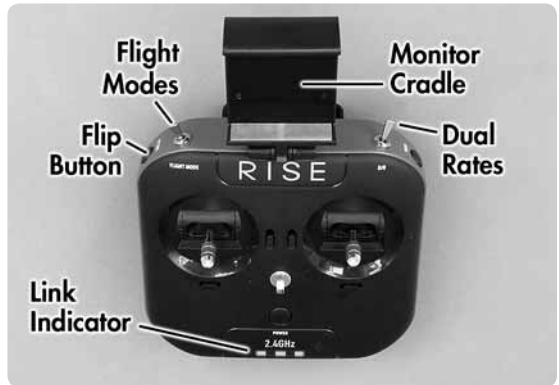
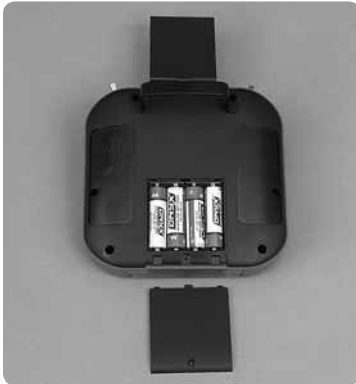

Remove the screw from the battery door. Insert 4 AA batteries in the battery compartment in the back of the transmitter.

NOTE: Always turn the transmitter on first.

FLYING

1. Turn on the transmitter and immediately connect the battery to the House Racer while the Link Indicator is flashing.
2. The Link Indicator will only flash for 5 seconds. If it stops flashing before the battery is connected, leave the battery connected to the quad and turn the transmitter off and back on to complete the link between the House Racer and the controller.
3. Set the quad on a flat surface for 10 seconds before arming the motors.

Status LED

Rapid Flash – No signal is being received from the transmitter.

Steady – With a single beep from the House Racer, the flight controller is linked with the transmitter.

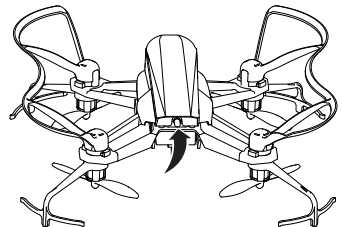

Medium Flash – With slow beeping from the House Racer, flight battery is almost depleted, land immediately.

Slow Flash – With slow beeping from House Racer, lost signal from controller (lost model beacon).

Controls

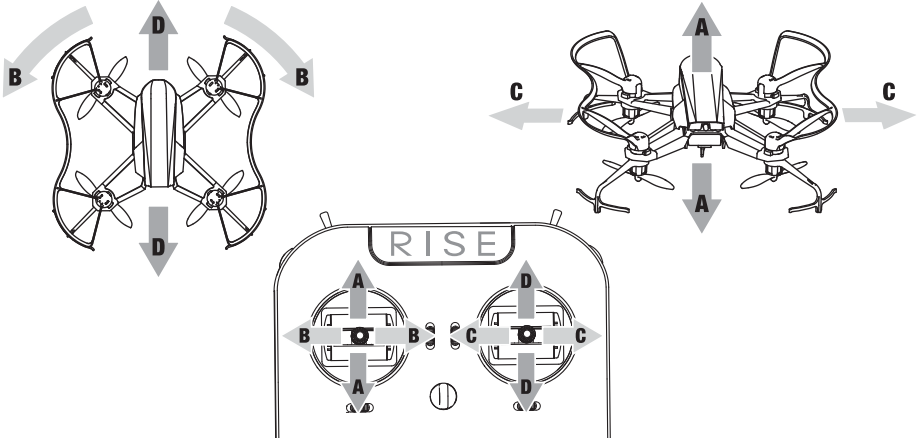

Sensor Calibration

1. **Calibrate the sensors before the first flight.** Turn on the transmitter. Center all the trim adjustments. To center the trim settings, hold down one side of the trim button until you hear a long beep. If the controller stops beeping, release the trim button and hold down the other side.
2. Plug in the House Racer and place it on a level surface.
3. Hold the right stick in its lower right corner.
4. Move the left stick **down** and to the right. When the LEDs on the House Racer start to flash, release both sticks. The LEDs will stop flashing when the calibration is complete.



Motor Arming

While the throttle is at its lowest setting, hold the yaw control to the right to arm the motors. Holding the yaw control to the left while the throttle is at its lowest setting will disarm the motors. The motors will also shut off if the throttle is at its lowest setting for more than 3 seconds.

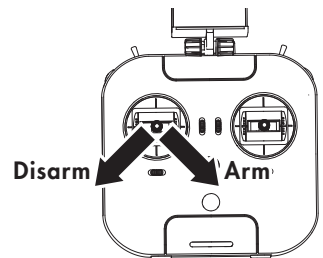

Flight Modes

The Vusion has 3 flight modes.

Mode 1 – This mode has autolevel, mild roll rates and limited tilt angles. Ideal for the pilot that is moving up from an entry level quadcopter.

FLIGHT MODES	Switch Position	Stability Mode	Tilt Angle	Roll Rate
Mode 1	Away	Stability	30	Low
Mode 2	Middle	Stability	45	Medium
Mode 3	Forward	Rate	360	High

Mode 2 – This mode still has autolevel, but has higher roll rates and higher control sensitivity. This mode is for the more experienced pilot.

Mode 3 – This mode (rate mode) has no limits on tilt and faster roll rates. The quad will not autolevel in this mode. This mode offers the most maneuverability and the ability to manually roll and flip, but requires the pilot to be able to control the attitude of the quadcopter at all times.

It normally takes a week or two of practice to learn to fly rate mode. Start by flying Line of Sight (no FPV) until you can comfortably control the quad. When you are comfortable making a manual flip, you should be ready to fly FPV in this mode.

Takeoff and Landing

Turn on the transmitter and connect the flight battery to the VUSION HOUSE RACER. Place the quadcopter on a level surface and let it sit for 10 seconds to let the flight controller set up the gyros.

To take off, arm the motors and advance the throttle at a moderate speed until the House Racer is at least 3 feet above the ground.

To land, hover the Vusion over the landing spot and slowly reduce the throttle. When the quadcopter is on the ground, disarm the motors.

IMPORTANT! Always unplug the battery as soon as you land.
Recharge before next use.

Auto-Flip

The House Racer can auto-flip when in Flight Mode 2.

1. Press the button on the left side of the controller.
2. Move the right stick in the desired flip direction.
3. Release the stick and button as soon as the flip starts so the controller is ready for use when the flip is completed.

FPV

The House Racer has a built in FPV camera and 40 channel VTX that transmits on the A, B, E, F and R bands.

FPV FREQUENCIES

BAND	1	2	3	4	5	6	7	8
A	5865	5845	5825	5805	5785	5765	5745	5725
B	5733	5752	5771	5790	5809	5828	5847	5866
E	5705	5685	5665	5645	5885	5905	5925	5945
F	5740	5760	5780	5800	5820	5840	5860	5880
R	5658	5695	5732	5769	5806	5843	5880	5917

1. Power up the House Racer.
2. Attach the FPV monitor antenna and turn on the monitor.
3. If the monitor is not displaying a signal from the House Racer, hold the "B" button on the monitor for 2 seconds and release it. The monitor will scan all the channels and lock onto the closest signal.
4. Place the monitor in the cradle on the transmitter or inside the goggle.

If the VTX channel must be changed, hold the camera button for a second to change the band. A quick tap on the button will change the channel.

The LED will display a letter for the band and a number for the channel that is selected.

Lines and static on the feed from the FPV camera are normal and will be more frequent as the House Racer gets farther from the pilot. The typical FPV range is 50 to 75 yards depending on how close sources of interference like Wi-Fi routers are to the flying area. If you have access to large open area to fly, replacing the antenna on the monitor with a circular polarized antenna like the Tactic FPV Cloverleaf Antenna (TACZ5305) will increase the FPV range.

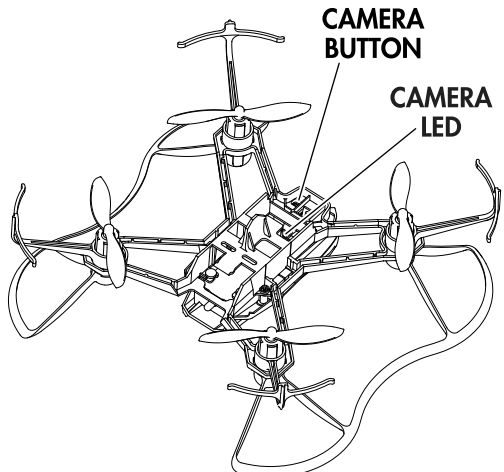

Flying FPV is more difficult than normally (Line of Sight) because it is difficult to determine altitude with just the camera.

Practice with a spotter so they can provide warnings and assist with locating the quad when it crashes. If possible, fly in an open area with grass.

Stay low until you can control the House Racer's height without assistance.

When you are comfortable flying in an open area, practice flying a pre-set course.

FAILSAFE / BEACON

The House Racer will autoland and start beeping when the signal from the transmitter is lost. This feature can be used as a beacon to help locate the quadcopter when it has crashed. Simply turn off the transmitter.

BATTERIES

The VUSION HOUSE RACER uses a 650mAh single cell LiPo. Typical flight time is 5 to 7 minutes depending on the flying style. Always unplug the battery after your flight!

The flight controller does have a low voltage cutoff to protect the LiPo from damage. The rear LED will flash and the House Racer will start beeping when the battery voltage drops to 3.4V. You should land the quadcopter as soon as possible when you hear or see the alarm to avoid damaging the battery. The House Racer will autoland when the battery voltage gets below 3.2V.

The flight battery should always be recharged before it is stored.

WARNING: Your battery life will be reduced and the battery can be damaged any time the battery voltage drops below 3.0V. Charging a battery that is damaged in any way can pose a fire hazard.

MAINTENANCE

Propeller Installation

Each arm and propeller on the House Racer is marked with the letter "A" or "B" and an arrow indicating proper rotation. The propeller must be installed on an arm with the same letter or the quadcopter will not be able to fly.

Carefully pry the damaged propeller off of the motor with a flat blade screwdriver.

Install the new propeller on the motor shaft and push it up as far as possible. Place the bottom of the propeller on a flat surface and push down on the arm. You will feel the propeller "pop" into place when it is completely installed on the motor shaft.

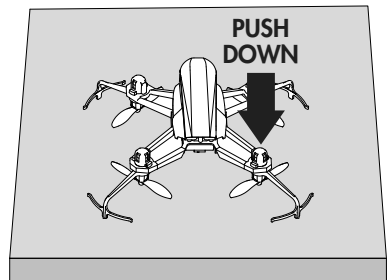
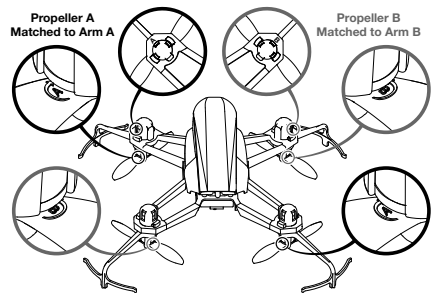

Link Transmitter

The House Racer can link to any nearby SLT transmitter or AnyLink. Always turn on your transmitter and place it close to the House Racer before connecting the flight battery. The House Racer will be beep and its status LED will be steady when it is linked to your transmitter.

If you are using the House Racer/Vusion controller, please refer to the procedure on page 6 in the FLYING section.

If you are using an SLT transmitter like the Tactic TTX650 or an AnyLink adapter, please make sure that your channel and switch settings match the following tables.

NOTE: Spektrum and JR radios should have the channels reversed.

CHANNEL ASSIGNMENTS				
Channel	Direction	End Points	Dual Rates	Expo
Aileron	normal	100/100	70/100	-30/-15
Elevator	normal	100/100	70/100	-30/-15
Throttle	normal	100/100		
Rudder	normal	100/100	70/100	-30/-15
Gear	normal	100/100		
AUX	normal	100/100		

SWITCH ASSIGNMENTS - Ch 6		
AUX	100%	Stability 1
AUX	0%	Stability 2
AUX	-100%	Rate

SWITCH ASSIGNMENTS - Ch 5		
Gear	-100%	Normal
Gear	100%	Flip

1. Turn off the transmitter and unplug the battery from the House Racer.
2. Turn on your transmitter.
3. Connect the battery to the House Racer.

After a few seconds, the status LED should be steady and the House Racer should beep once to indicate that it is linked to the controller.

NOTE: Always turn on the controller **before** connecting the battery to the House Racer.

Replacing a Motor

Removing a motor on the House Racer is very easy.

1. Unplug the motor wire connector from the flight controller with a small flat blade screwdriver.
2. Pull the motor wire from the arm.
3. Remove the propeller and prop guard.
4. Twist the motor cap to unlock it from the arm and remove it.
5. Push the motor up and out of the motor housing.

Before installing the new motor, make sure the wire colors are the same as on the old motor.

BATTERY PRECAUTIONS

The VUSION HOUSE RACER uses a lithium polymer (LiPo) battery. Follow these precautions to ensure safe and trouble-free operation.

- ALWAYS disconnect the battery from the quadcopter when not in use.
- Do not attempt to use this charger with NiCd or NiMH battery packs.
- Do not attempt to use a damaged battery.
- This product contains a LiPo battery that must be recycled or disposed of properly.
- Do not leave the charger unattended while charging. Disconnect the battery and unplug the charger immediately if either becomes hot! However, it is normal for the charger to get warm.
- Disconnect the battery from the charger and carefully move the battery to a fireproof location if the battery begins to swell or smoke!
- Never allow the battery temperature to exceed 140° F [60° C].
- Do not attempt to charge a battery if it is swollen or hot.
- Do not place the charger or any battery on a flammable surface or near combustible materials while in use.
- Never disassemble or modify pack wiring in any way or puncture cells.
- Never charge inside a vehicle.
- Always disconnect the battery and unplug the charger when not in use.
- Land your model immediately when the LEDs flash to indicate that the battery power is low. Recharge the battery before attempting another flight. A dangerous situation can occur when attempting to recharge an over-discharged battery!
- ALWAYS keep a supply of sand accessible when charging. Dumping sand on the battery will extinguish a LiPo chemical fire.
- ALWAYS KEEP OUT OF REACH OF CHILDREN

For additional information about recycling rechargeable batteries in the US and to locate a local collection point, please visit the Call2 Recycle website at <http://www.call2recycle.org/>

CAUTION: RISK OF EXPLOSION IF BATTERY IS REPLACD BY AN INCORRECT TYPE. DISPOSE OF USED BATTERIES ACCORDING TO THE INSTRUCTIONS.

FCC IC PRECAUTIONS

IC RSS Warning

This device complies with Industry Canada licence-exempt RSS standard(s). Operation is subject to the following two conditions: (1) this device may not cause interference, and (2) this device must accept any interference, including interference that may cause undesired operation of the device.

IC Radiation Exposure Statement

This equipment complies with IC RF radiation exposure limits set forth for an uncontrolled environment. This transmitter must not be co-located or operating in conjunction with any other antenna or transmitter.

FCC Radiation Exposure Statement

This device complies with part 15.249 of the FCC rules. Changes or modifications not expressly approved by Tactic will void the user's authority to operate this Tx. Operation is subject to the following two conditions:

- (1) This device may not cause harmful interference.
- (2) This device must accept any interference received, including interference that may cause undesired operation.

NOTE: This equipment has been tested and found to comply with the limits for a Class B digital device, pursuant to part 15 of the FCC Rules. These limits are designed to provide reasonable protection against harmful interference in a residential installation. This equipment generates uses and can radiate radio frequency energy and, if not installed and used in accordance with the instructions, may cause harmful interference to radio communications. However, there is no guarantee that interference will not occur in a particular installation. If this equipment does cause harmful interference to radio or television reception, which can be determined by turning the equipment off and on, the user is encouraged to try to correct the interference by one or more of the following measures:

- Reorient or relocate the receiving antenna.
- Increase the separation between the equipment and receiver.
- Connect the equipment into an outlet on a circuit different from that to which the receiver is connected.
- Consult the dealer or an experienced radio/TV technician for help
- This equipment should be installed and operated with minimum distance 20cm between the radiator and your body.

RISE J2000 Transmitter FCC ID: IYFJ2000

RISE 25mW VTx FCC ID: IYF2051

CE COMPLIANCE INFORMATION FOR THE EUROPEAN UNION

Instructions for Disposal of Waste Equipment by Private Users in the European Union

Correct Disposal of this product. This symbol on the product or packaging indicates that this product should not be disposed with other household wastes throughout the EU. To prevent possible



harm to the environment or human health from uncontrolled waste disposal, recycle it responsibly to promote the sustainable reuse of material resources. For more information about where to recycle this product, please contact your local city office, household waste disposal service or the location where the product was purchased.

Declaration of Conformity

Product: RISE 2.4GHz 6-Channel Tx Rx

Item number: RISJ2000 J2000

Equipment class: 1

J2000 transmitter: The objects of the declaration described here are in conformity with the requirements of the specifications listed below, following the provisions of the European 2006/95/EC Low Voltage Directive:

EN 60950-1:2013 Safety

The objects of the declaration described here are in conformity with the requirements of the specifications listed below, following the provisions of the European R&TTE directive 1999/5/EC:

EN300 328 V1.9.1.

Technical requirements for radio equipment

ETSI EN 300 328 V1.9.1 (2015-02); ETSI EN 301 489-1 V1.9.2 (2011-09); ETSI EN 301 489-3 V1.6.1 (2013-08); EN 62479:2010 General EMC requirements for radio equipment

Product: RISE 5.8GHz 25mW VTx

Technical requirements for radio equipment

ETSI EN 300 440-2 V1.4.1 (2010-08); ETSI EN 301 489-1 V1.9.2 (2011-09); ETSI EN 301 489-3 V1.6.1 (2013-08); EN 62479:2010 General EMC requirements for radio equipment

Hobbico, Inc.

2904 Research Road
Champaign, IL USA 61822



SPARE PARTS

Part #	Description
1	RISE2050 Canopy
2	RISE2051 Camera Board & Antenna
3	RISE2052 Camera Case
4	RISE2053 Screw Set (6)
5	RISE2054 Motor Cap (4)
6	RISE2055 Main Motor CW L/F, R/R (2)
14	RISE2056 Main Motor CCW R/F, L/R (2)
7	RISE2057 Prop Guards (4)
8	RISE2058 Main Frame
9	RISE2059 Props (4)
10	RISE2060 Control Board w/ Dampers
11	RISE2061 Dampers (4)
12	RISE2062 Wall Guards (2)
13	RISP2065 650 mAh LiPo Battery
	RISP2066 USB Charger
	RISJ2000 Transmitter 6-channel
	TACZ1003 MicroUSB Charge Cord

Goggle Parts

TACZ5200	FPV-G1 Goggles w/o Monitor
TACZ5610	FPV-G1 Head Strap
TACZ5612	FPV-G1 Face Plate Foam

FPV Monitor Parts & Accessories

TACZ5160	FPV-RM2 40ch 5.8 GHz Monitor
TACZ1010	4G Class 10 Micro Memory Card
TACZ5300	FPV 5.8 GHz RP-SMA Tx Antenna Short 110 mm 3dBi
TACZ5305	FPV 5.8 GHz Cloverleaf Antenna 3dBi
TACZ5600	FPV-RM2 Sun Shield
TACZ5602	FPV-RM2 Tripod Mount

Other Optional Parts & Accessories

TACZ5604	USB Micro SD Card Reader
TACJ2650	TTX650 6-channel SLT Computer Transmitter

OPTIONAL RACING GATE SYSTEM



Checkered Flag Gate RISP0003



Elevated Gate RISP0005



Pylon Gate RISP0004



Arch Gate RISP0006



LED Ring Gate* RISP0007



Ring Gate* RISP0002

* The Ring Gates come with genuine 3M™ Command™ strips so they can be mounted on a wall or ceiling.

Command™ and 3M™ are trademarks of 3M, Inc.

HOUSE RACER EXPLODED VIEW

