



Nine Eagles®

Bravo SX

NE R/C 320A Helicopter

Instruction Manual



INDOOR AND OUTDOOR FLYING

NOTHING FLIES LIKE NINE EAGLES

■ 320010827

To ensure safe use, please read this manual thoroughly before flying the helicopter.

Safety Protection Advantage:

Bravo Sx can bind with transmitter before the helicopter keep 3 seconds quiet state.

Catalogue

Introduction	1
Warning and FCC Information.....	3
Specification.....	6
Product List.....	7
Exploded View.....	8
Transmitter Control Identification.....	12
How to fly.....	15
Operate Test.....	17
Choosing a Flying Area.....	20
Flight Training	20
Notify Items.....	22

Introduction

Bravo Sx is Nine Eagles latest 2.4GHz 4-channel micro single blade helicopter developed by ourselves. It is small, light weight and can be flying indoor and outdoor. It has excellent control functions and advanced balance operation system. Easy operation, stable flight. It is the best choice for Single Blade Beginners to get into!

Patent Introduction

BALANCE SYSTEM FOR REMOTE CONTROL HELICOPTER

1. Invention patent No: 200710170488.2
2. Utility Model Patent No: 200720076261.7

CONTROL SYSTEM FOR SINGLE BLADE REMOTE CONTROL HELICOPTER

1. Invention patent No: 200810036355.0
2. Utility Model Patent No: 20082005752 8.2

PCT patent of "SINGLE ROTOR MODEL HELICOPTER WITH IMPROVED STABILITY BEHAVIOR".
PCT No is: WO/2009/062407

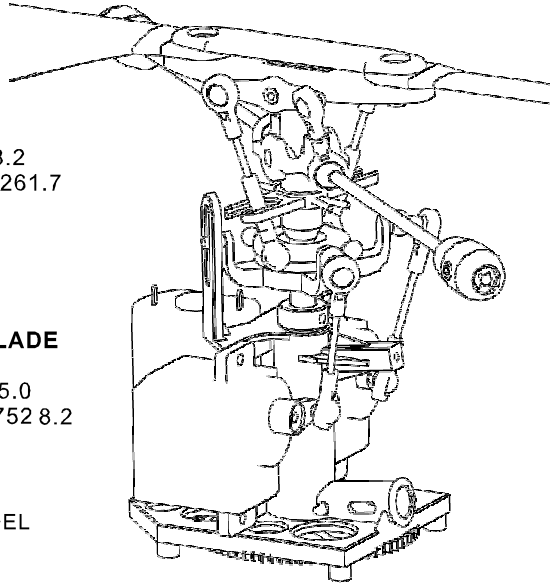

AEROMODELLING TRANSMITTER: ALLOW MODE 1 AND MODE 2 CONVERTIBLE ONLY BY ANTENNA

1. Invention patent No; 200810202731.9
2. Utility Model Patent No: 200820155365.1
3. USA Patent 12/554,309

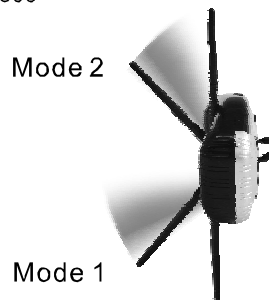

RECHARGEABLE BATTERIES OF AEROMODELLING: THE TWO POLAR OF BATTERY BINDING WITH BATTERY AND AEROMODELLING

Utility Model Patent No: 200920067262.4,



Warning and FCC Information

■ *Warning and FCC Information*

The Nine Eagles® NE R/C320 A(Bravo Sx) is not a toy. Children under 14 years old are strictly forbidden from flying this helicopter.

You must fly this helicopter safely.

When flying or preparing the helicopter for flight you should strictly adhere to the instructions. Ensure that yours and other people's hands, and face are kept away from the rotating parts.

Always use the helicopter indoors or outdoors.

Always unplug the helicopter battery before turning off the transmitter when the helicopter is stopped.

Helicopter uses a lithium polymer battery. Always adhere to operating instructions for the lithium polymer battery to avoid accidents such as combustion or explosion.

Always use a genuine Nine Eagles® charger and power adaptor designed for this helicopter.

Always unplug the charger and adapter from the electrical outlet after completion of each charge.

Never overcharge the battery, avoid use in direct sunlight or near fire. Ensure the battery is kept dry.

Never store or transport the battery with metal objects.

Never disassemble the battery.

Never use wet hands when in contact with the charger, battery or power adaptor.

When you fly the helicopter, keep distance from other electrical equipment, magnetic objects, wireless devices. etc, to avoid interference and accidents.

This device complies with part 15 of the FCC rules. Operation is subject to the following two conditions:

- 1) This device may not cause harmful interference, and
- 2) This device must accept any interference received, including interference that may cause undesired operation.

NOTE: This equipment has been tested and found to comply with the limits for a Class B digital device, pursuant to part 15 of the FCC rules. These limits are designed to provide reasonable protection against harmful interference in a residential installation. This equipment generates, uses and can radiate radio frequency energy and, if not installed and used in accordance with the instructions, may cause harmful interference to radio communication. However, there is no guarantee that interference will not occur in a particular installation. If this equipment does cause harmful interference to radio or television reception, which can be determined by turning the equipment off and on, the user is encouraged to try to correct the interference by one or more of the following measures:

- 1) Reorient or relocate the receiving antenna.
- 2) Increase the separation between the equipment and receiver.
- 3) Connect the equipment into an outlet on a circuit different from that to which the receiver is connected.
- 4) Consult the dealer or an experienced radio/TV technician for help.

■ **Instructions for Disposal of WEEE by Users in the European Union**



This product must not be disposed of with other waste. Instead, it is the user's responsibility to dispose of their waste equipment by handing it over to a designated collection point for the recycling of waste electrical and electronic equipment. The separate collection and recycling of your waste equipment at the time of disposal will help to conserve natural resources and ensure that it is recycled in a manner that protects human health and the environment. For more information about where you can drop off your waste equipment for recycling, please contact your local city office, your household waste disposal service or where you purchased the product

■ **Li-Po Battery Safety Guidelines**



Lithium Polymer batteries are significantly more volatile than alkaline or NiCd/NiMH batteries used in RC applications. All manufacturer's instructions and warnings must be followed closely. Mishandling of LiPo batteries can result in fire. Always follow the manufacturer's instructions when disposing of Lithium Polymer batteries.

If you are unsure of how to charge the battery included with this product, please seek the advice of your local hobby shop.

WARNING

Charging and discharging the batteries has the potential for fire, serious injury to persons and damage to property. The user of this battery agrees to accept responsibility for all such risks. Nine Eagles[®], its affiliates, distributors, and retail partners can not control the use, application, charging or installation of this product and shall not be held responsible for any accident, injury to persons, or damage to property resulting from the use of this product. Read all safety guidelines, charging instructions, and battery disposal instructions before using batteries. Store battery packs out of the reach of children and pets. Children under the age of 18 must be supervised by a responsible adult. Children under 14 years of age should not be permitted to use this product under any circumstances. This product contains chemicals known to the State of California to cause Cancer, Birth Defects and other Reproductive Harm.

LI-PO BATTERY WARRANTY

This product is warranted against defects in original material and workmanship only. No term warranty is offered with this product. In no case shall Nine Eagles[™] liability be greater than the actual retail purchase price of this product.

SPECIFIC SAFETY GUIDELINES

1. Store in a fire proof container and charge on an open fire proof surface.
2. Charge in a protected area devoid of combustibles. Never leave the charging process unattended.
3. In the event of damage carefully remove the battery to a safe place to observe for at least half an hour. Damaged batteries are likely to explode. Never attempt to charge a damaged battery, no matter how slight the damage. Dispose of damaged batteries as the instructions below.
4. Only use the Nine Eagles balanced charger designed for this battery. Never use

chargers designed for Ni-CD batteries. If the batteries show any sign of swelling, remove them to a safe place outside as they could erupt into flames.

- 5.MOST IMPORTANT – Never plug in a battery and leave to charge overnight. Serious fires have resulted from this practice.
- 6.Do not attempt to make your own battery packs from individual cells.

If the battery pack involved in a crash or is otherwise damaged

- 1.Remove the pack from the model.
- 2.Inspect the pack for damage to the wiring or connections
- 3.If necessary, disassemble the pack and dispose of any damaged cells

Disposal of Li-PO batteries

- 1.Put the pack in a safe open area and connect a moderate resistance across the cell terminals until the cell is completely discharged.
CAUTION: The pack may get extremely hot during the discharge
- 2.Puncture the plastic envelope and immerse in salt water for several hours.
- 3.Place in your regular rubbish bin.

Specification

Model No: NE R/C 320A
Rotor Diameter: 190mm
Overall Length: 229mm
Weight: 33g
Power System: Motor X 2pcs
Battery: 1-cell 3.7V 150mAh Li-PO

Product List

Description	QTY
Bravo Sx	1
2.4GHZ Transmitter	1
Li-Po Battery	1
AA Battery	4
Screwdriver	1

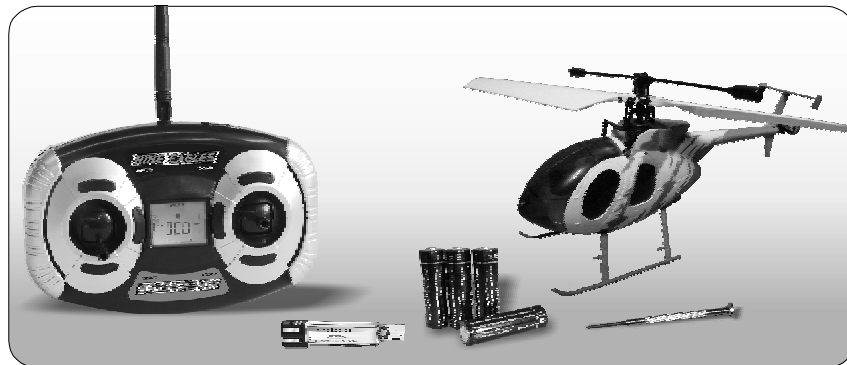

Warrant: *NineEagles guarantees all the helicopters have been strictly inspected, tested before export from factory. Please contact your local distributor to get the technology support to purchase the spare parts and replacement. We have the detail explorer drawing to help you identify the broken spare parts.*

Exploded View

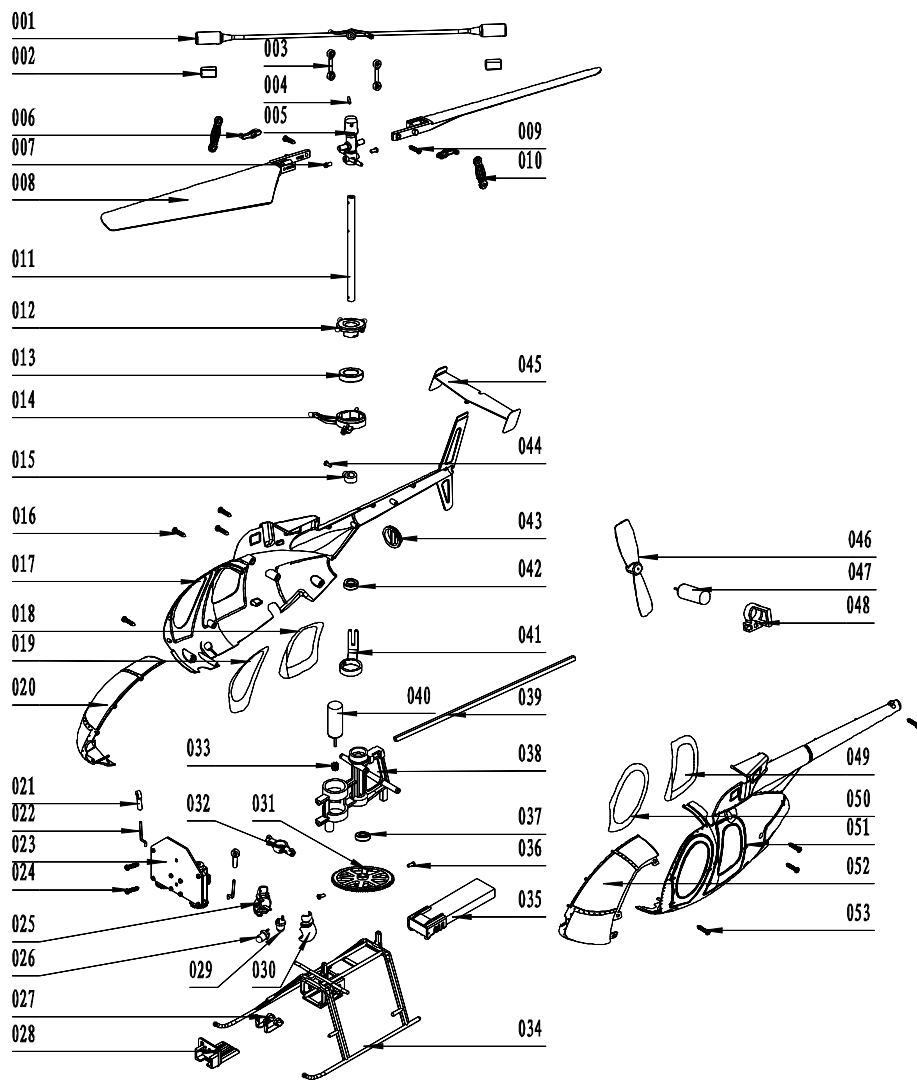

NOTICE: If you need buy some spare parts replaced during flying, please order according to the color page.

■ Exploded View Parts Listing

NO	STOCK NO	NAME	UNIT	QTY
	NE402320001A	Cabin Set		
051		Right Cabinet	PCS/SET	
017		Left Cabinet	PCS/SET	
052		Left Hood	PCS/SET	
020		Right Hood	PCS/SET	
050		Left Front Window	PCS/SET	
019		Right Front Window	PCS/SET	
049		Left Rear Window	PCS/SET	
018		Right Rear Window	PCS/SET	
043		Nozzle	PCS/SET	
045		Horizontal Tail	PCS/SET	
	NE4260015	Rotor Blade Set		
008		Rotor Blade	PCS/SET	
	NE4260003	Fly Bar Set		
001		Fly Bar	PCS/SET	
002		Weight Block	PCS/SET	
		Fixed Pin Balance Bar Set		
004		Fixed Pin Balance Bar	PCS/SET	
		Main Shaft Set		
011		Main Shaft	PCS/SET	
005		Rotor Blade Head	PCS/SET	
015		Outside Shaft Fixed Ring	PCS/SET	
044		Screw PM1.2x2.5	PCS/SET	
	NE4210007	Swashplate Set		
012		Upper Swashplate	PCS/SET	

NO	STOCK NO	NAME	UNIT	QTY
014		Lower Swashplate	PCS/SET	
013		Bearing	PCS/SET	
	NE402320007A	Main Frane Set	PCS/SET	
038		Bearing Housing	PCS/SET	
041		Outer Shaft	PCS/SET	
031	NE10126004006	Main Gear	PCS/SET	
	NE402320008A	Ball Linkage Rod Set		
003		Upper Ball Linkage Rod	PCS/SET	
010		Middle Ball Linkage Rod	PCS/SET	
021		Lower Connecting Plastic Set	PCS/SET	
006		Mixed Rockers Set	PCS/SET	
022		Push and Pull Wire	PCS/SET	
	NE402320009A	Tail Set	PCS/SET	
039		Tail Rod	PCS/SET	
048		Tail Motor Holder	PCS/SET	
047		Tail Motor	PCS/SET	
046	NE10126004007	Propeller	PCS/SET	
	NE402320011A	Landing Skid Mount Set		
034		Landing Skid	PCS/SET	
027		Battery Needle 2	PCS/SET	
028		Power Switch Mounting Plate	PCS/SET	
	NE4260009	Bearing Set		
037/042		Bearing	PCS/SET	

NO	STOCK NO	NAME	UNIT	QTY
	NE4260010	Screw Set	PCS/SET	
007/004		Screw PM1.2x2.5	PCS/SET	
009/024		Screw ST1.3x5PA	PCS/SET	
016/036/053		Screw PM1.2x3.5PA	PCS/SET	
041	NE4312009	LED Set		
025		Connector Plug		
032		Fixed Mount	PCS/SET	
030		Connector Box		
029		Blue LED	PCS/SET	
026		White LED	PCS/SET	
	NE402320013A	Motor Set		
040		0820Motor	PCS/SET	
033		Motor and Gear	PCS/SET	
035	NE411927001A	Battery Set		
023	NE407631001A	Recover Set		

Transmitter Control Identification

When the transmitter is MODE1:

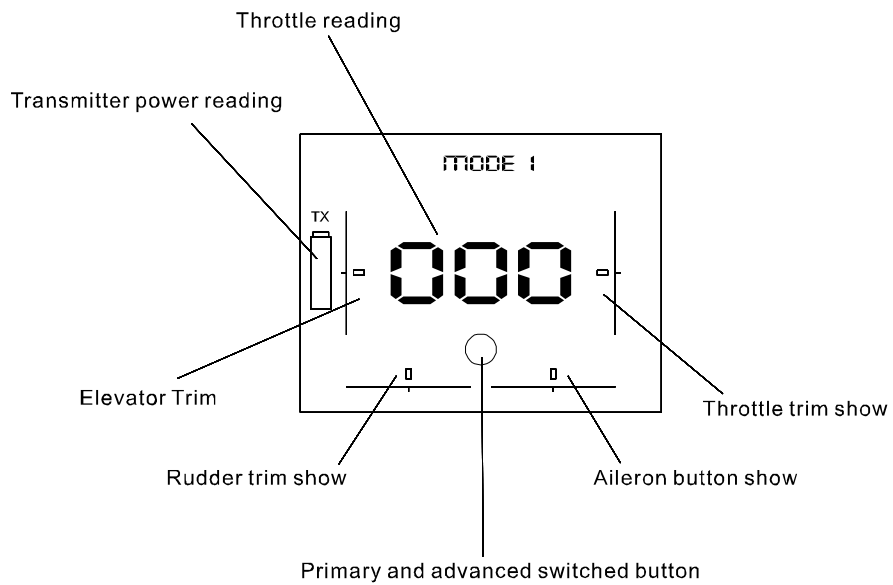
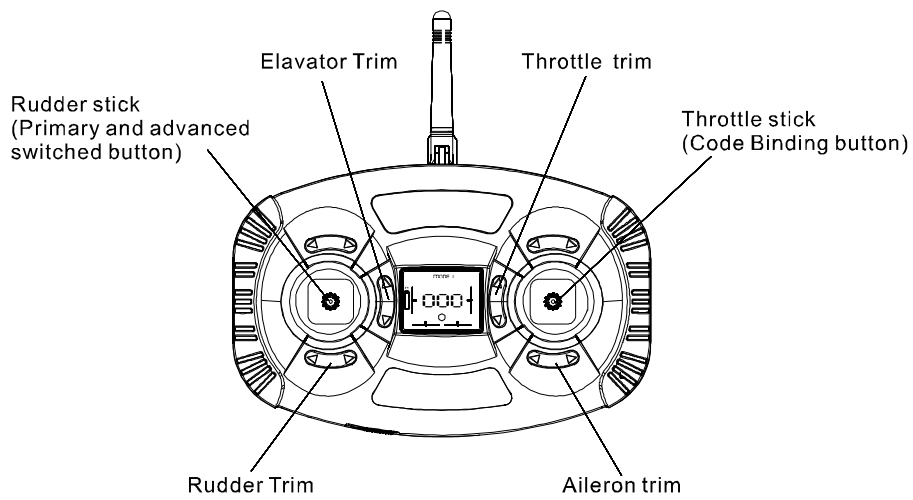

When the transmitter is MODE2:

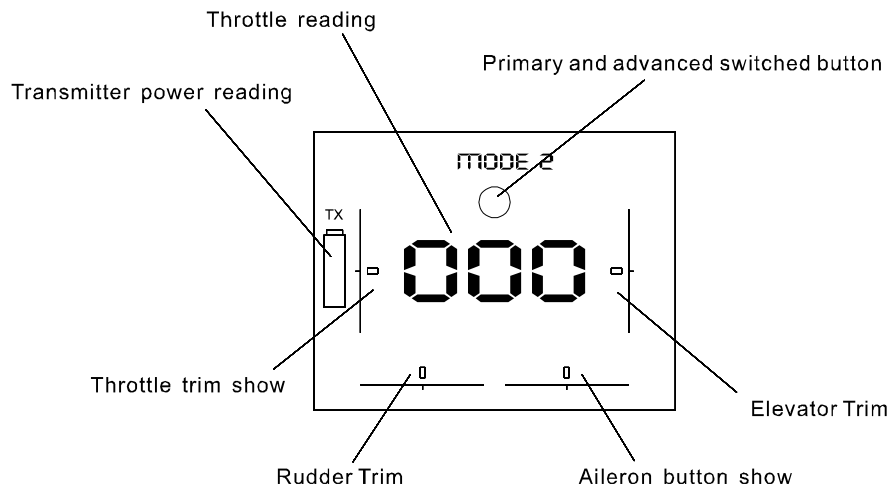
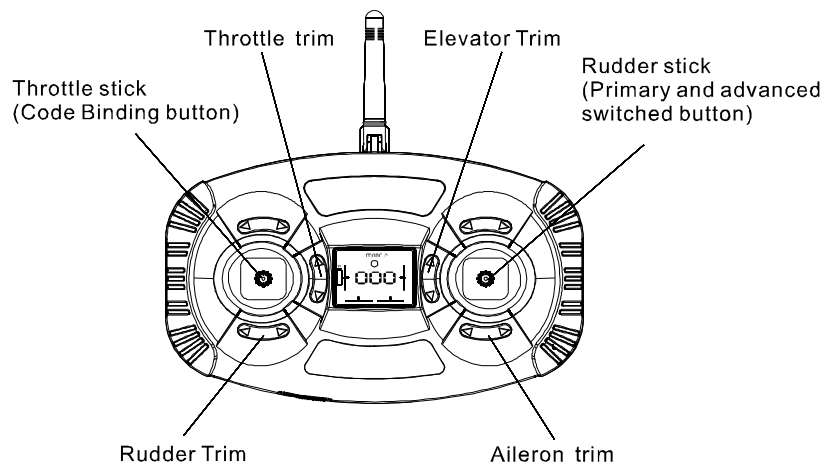

■ Set up the Primary and Advanced Control Switch

We have set up the primary and advanced control model to meet the different fans requirement.

1. Turn on the transmitter
2. Press the button to change mode between primary and advanced.

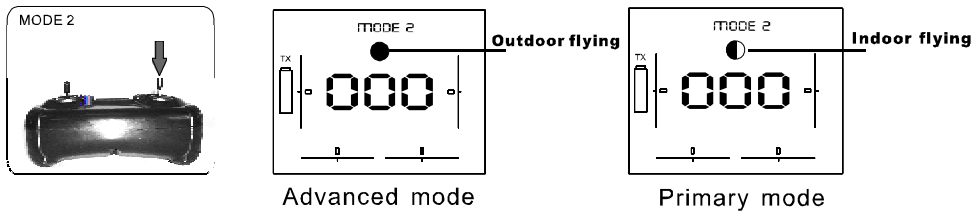

Note: *This throttle curve in the low rate mode is also different than it is in the high rate mode. This makes it much smoother and easier to control the throttle when in the low rate mode.*

The advanced mode is suitable for the experienced pilot. We suggest you choose the primary mode when you first flight the helicopter.

■ Transmitter Mode Switch Function

In order to meet the different customer requirement, we use the transmitter with the mode switch function.

Please go ahead the following process to switch the mode from Mode2 to Mode1 :

1. Turn off the transmitter.
2. Turn off the fixed nut on the antenna and clip.(PICTURE 1)
3. Reverse the antenna 90 degree , circumrotate the antenna shaft 180 degree,then make the antenna to cling another side of transmitter.(PICTURE 2)



PICTURE 1

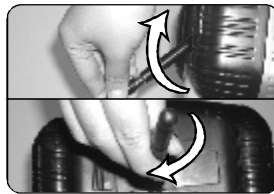

PICTURE 2



PICTURE 3

4. Re-install the nut and the fix clip on the antenna.(PICTURE 3)
5. Turn on the transmitter and to be the mode1 operation check.

■ **Battery Charging**

A. Ensure the transmitter contain batteries with enough power.

B. Take off the battery box cover of transmitter.



C. Slide the Li-PO battery into the slot on the transmitter until you make the connection successfully ,then turn on the power of transmitter, the indicative green light on the charger will solid green.

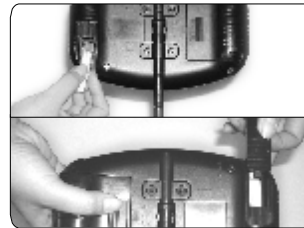

D. When the battery is fully charged , the green light will go out entirely.

How to Fly

1. Take off the transmitter cover
2. Install four AA batteries in the transmitter
3. Turn on the power , check whether there is any content on LCD.
4. Slide the li-po battery into the battery slot on frame of helicopter. Please slide the battery according to the arrow direction

Start process:

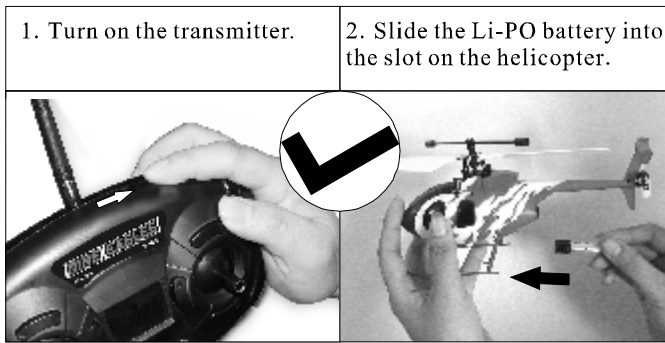

Right operation

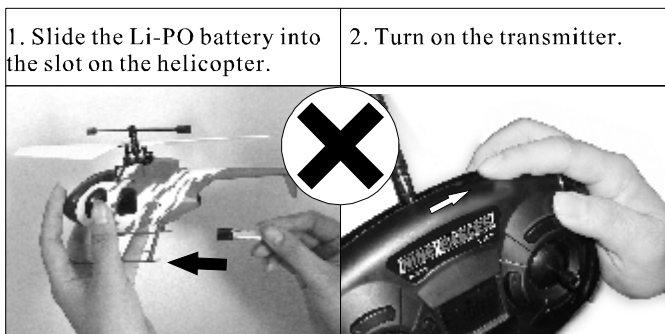

Wrong operation

Set the throttle stick on the lowest position, No touching the sticks when turn on the power, The transmitter has the automatic calibration function to guarantee the helicopter is on the best status.

Warning: Failure to comply with any of the instruction of this manual to mis-operation ,it could lead to unnecessary injury .

■ Helicopter and transmitter binding

We have bind the helicopter and transmitter before export the cargos from factory. If you need re-bind the code ,please take the following step.

1. Press the binding button and do not loose your finger, At the same time, turn on transmitter power, Then LCD glitter while the transmitter beeps.

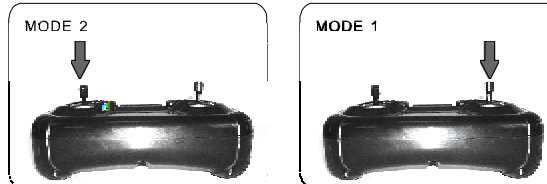

2. Slide the Li-PO battery into helicopter, then waiting for the end of binding.

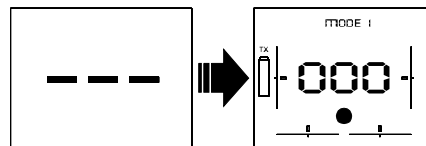

3. After binding successfully, LCD of transmitter stops glitter, and the transmitter enter into the normal operation.

Note: You can't bind the transmitter and receiver until the throttle set up on the zero graduation and the green light solid green. If the LED light flashes, please set up the throttle to zero graduation then the Helicopter can normally bind.

Safety Protection Advantage:

Bravo Sx can bind with transmitter before the helicopter keep 3 seconds quiet state.

Operate Test

Trim adjustments

Before your first flight, make sure your trim levers are in the middle position excluding the throttle trim. The throttle trim is required to always be at the lowest or the helicopter blades won't stop spinning when the throttle stick is pulled all the way back.

NOTE: The helicopter has a built in throttle fail safe. The helicopter rotors will not turn ON during initial power up unless the trim tab is below center and the throttle stick is all the way back.

(In Mode 2)

Throttle Trim Adjustment

If your rotors start to spin without adding any throttle or if they do not spin when you do add throttle, your throttle trim needs to be adjusted. If the rotor start to spin without any throttle, slide the throttle trim lever down until they stop. If they do not spin, even when you add throttle, please push the throttle trim lever until the blades start spinning



Yaw(Rudder) Trim Adjustment

If while hovering, your Helicopter's nose begins to rotate when no yaw control input is being added, you will need to adjust the yaw trim. If nose rotates to the left, push the yaw trim lever to the right until it stops. If nose rotates to the right push the yaw trim lever to the left until it stops.



Pitch(Elevator) Trim Adjustment

If while hovering, your Helicopter begins to move forward or back when no pitch control input is being added, you will need to adjust the forward/back pitch trim lever. If it moves forward, push the pitch trim lever down until it stops. If it moves backward, push the pitch trim lever up until it stops.













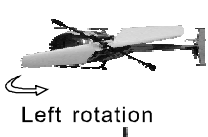





















Roll(Aileron) Trim Adjustment

If your Helicopter begins to move left or right when no roll control is being added, you will need to adjust the roll trim lever. If it moves left, push the roll trim lever to the right until it stops. If it moves right, push the roll trim lever to the left until it stops.



■ Operation skills

Mode 1			
Throttle	Rudder	Elevator	Aileron
 up 	 Left rotation 	 Forwards 	 Right movement 
 down 	 Right rotation 	 Backwards 	 Left movement 

Mode 2			
	Rudder	Elevator	Aileron
 up 	 Left rotation 	 Forwards 	 Right movement 
 down 	 Right rotation 	 Backwards 	 Left movement 

Choosing a Flying Area

When you are ready for your first flight, you will want to select a relatively open indoor area that is free of people and obstructions. And while it is possible for experienced pilots to fly the Bravo Sx in relatively small indoor areas and outdoor as well with great success due to its size and controll ability, we strongly recommend it fly without any object area.

Once you have properly trimmed your helicopter and become familiar with its handling and capabilities, you will be able to fly in other smaller or open areas.

Flight Training

■ *Operation Procedures*

1. Place the Helicopter in the middle of the room, you should always stand approximately 2m (6ft) from the helicopter and behind the tail. Make sure the helicopter and transmitter have been set up and adjusted in accordance with this handbook. Switch the Transmitter on, connect the battery, and check once more that the servos are operating correctly before proceeding.
2. Now you are ready to start learning to fly. The control diagrams on the front few pages can help you trim and fly the helicopter.
3. Initially you do not need to worry about how to operate your Helicopter skillfully. Through practice, you will become more confident operating the controls and adjusting the throttle. When your fingers respond to the movements of the helicopter spontaneously, you are ready for more advanced flying. Please note the direction described here if you are facing the tail of the helicopter.
4. Push the throttle up gradually until the Helicopter starts to become light and then carefully move the throttle stick further until it lifts off. Observing the helicopter's response, correct any movement if necessary. Don't fly too high, keep its height above the floor at about 0.5m (1.6ft). If there is any instability, shaking, or if the helicopter is out of control, please land at once. The only thing

hat helps at this stage is to practice and then practice some more.

5. Take off from the Ground. The helicopter can take off after trimming. Push the throttle stick up, the rotating speed will increase. Push the throttle stick up firmly before the helicopter takes off the ground. When the helicopter takes off, slow down the speed and keep the helicopter about 0.5 meters high above ground. Observe how the helicopter is moving and trim it until it is at its best.

6. The beginner should concentrate their effects on vertical control and the direction control. First, you should control the throttle stick. After the helicopter takes off, slowly push the stick up or down. And control the sticks to keep the tail facing you.

7. Do not fly the lower 0.3 meters high above the ground, because the airflow under the rotating blades may cause the ground effect and affect normal flying and operation.

8. After you have learned how to take off and hover the helicopter, it is better to learn other movements in safe conditions.

■ Practice

Frog jump(control the power immediately after taking off),

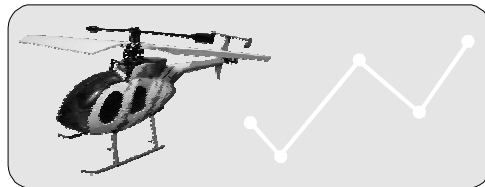

- ▲ Extend the time of the frog jump
- ▲ Hover around the tail
- ▲ Learn the right/left, forward/backward flying
- ▲ 360 degree rotation circle flying
- ▲ Box pattern practice

1) With the tail towards you, fly the Helicopter in a box pattern. Slide the helicopter sideways, forwards and backwards instead of turning the helicopter.

2) Repeat the box pattern facing the side of the helicopter.

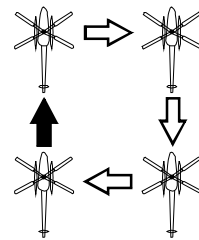

Pilot
1) Box Pattern

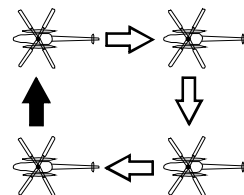

Pilot
2) Box Pattern

3) Repeat the box pattern with the front of the helicopter facing you.

▲ "8" shape flying

▲ Flight route flying

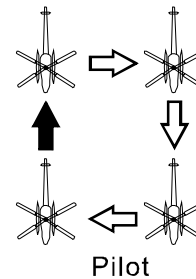

3) Box Pattern

Notify Items

- 1). Please stop flying when you feel the battery is running low. This is indicated by poor response from the Helicopter .
- 2). Always unplug the helicopter battery immediately and then turn off the transmitter when you are finished flying.
- 3).When the helicopter has crash some objection ,please loose the throttle ASAP to avoid some damage (please check the spare parts ASAP when the crash happened. You can purchase the spare parts from the Nine Eagles local distributor when you change the broken spare parts).
- 4). If you do not use the helicopter for a long time ,please keep 50% power of the Li-PO Battery ,and take the batteries out of the transmitter.

NOTHING FLIES LIKE NINE EAGLES

SHANGHAI NINE EAGLES ELECTRONIC TECHNOLOGY CO.,LTD

Factory : MaLu industrial zone. Jia Ding district.
shanghai. 201801 PR. China

Tel: 0086-21-52919366

Fax: 0086-21-52919361

<http://www.nineeagle.com>

E-mail: sales@nineeagle.com

