

Staudacher S600

Building Instructions

Before starting to build, we urge you to read through these instructions while reviewing the plans. They contain some important building sequence as well as instructions and warnings concerning the assembly and use of this model. At least read what we have to say and then make your own determination. It will save you some time. We expect that you have had building experience so, every minute detail is not covered. However the instructions and plans together will allow you to produce a first class model.

WING CONSTRUCTION

1. Remove the foam cores from their packing and inspect them. Hold up a panel and view it from the front leading edge. Notice that one surface is flat and the other is tapered. Lay a square on one surface. If the root is square to it, that's the top. Mark each panel once you have identified the top surface. Handle the cores carefully because of the sharp trailing edge. **Do not throw away the core packing shells.** They will be needed during the construction of the wing.

2. Sand the surfaces of the core lightly, if necessary, with 220 grit paper to remove any ridges and irregularities you might find. Do not over-sand.



3. Locate and install the fiber spar tube in each wing core. Spread a thin coat of epoxy or white glue around the periphery and length where it comes in contact with the foam. Insert into the core with a twisting motion. Slip W2 over the end, with proper orientation before the tube is completely inserted against the wall of the cut out. Use epoxy to secure W2 to the foam and tube. Wipe off the excess glue around the exit point at the wing root allowing it to extend 3/16" minimum. It is important this area be free of glue so that W1 can be installed over the fiber tube. Allow the glue to cure thoroughly before continuing on with further construction. **Note: when working on a wing panel, always make sure it is resting in a packing to prevent warping.**

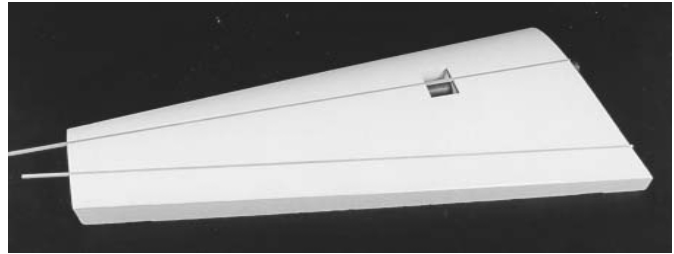

4. Locate the 8 - 1/4" sq. hardwood spars and glue them in the spar slots with epoxy or white glue. Make sure they are seated in the groove and flush with the top surface. If groove is too deep apply Balsa Magic on top of spar to make it flush with foam. It is easily sanded after it cures. We cannot control the tolerance on the hardwood strips. Work with the core in the packing to prevent warping.



5. Find W3 and W3A and epoxy them on the forward edge of the spar and against the tube in the square cut out area. W3A, on the bottom, has a slight taper so trial fit it first before gluing in.

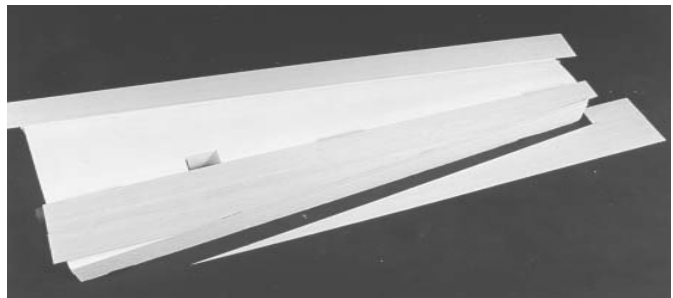

6. Locate 4 - 3/32" x 4" x 48" balsa sheet. True up the edges on one side taking off the minimum of balsa, using a long straightedge. Now do the other three. Next find 8 - 3/32" x 3" x 48" sheets and true up the edges with a long straight edge. Edge glue two sheets together making up 4 skins. It is best to use white glue here. It sands easier. Block sand each of the skins on one side. It's easier at this time. Place the edge of one skin on the centerline of the forward spar. Tape it in place. Using the core leading edge as a guide, offset a line 1/4" from it to obtain the configuration required for the skin. Now cut this out as

Staudacher S600

shown in the photo. Trim off a length from the sharp pointed end to fill in the small piece required near the wing root. Save the rest for scrap when needed.

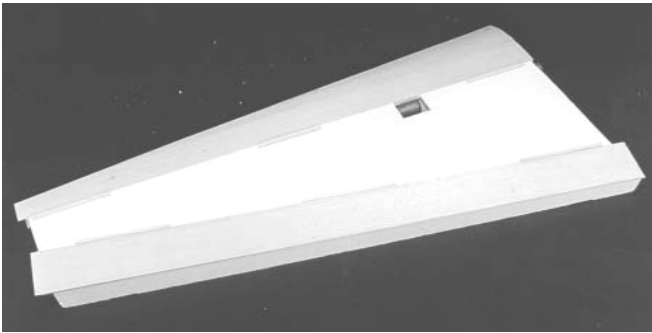

7. We recommend using epoxy to glue on the skins. A good epoxy like: Hobbypoxy II, Smooth 'N' Easy, Zap 30-min epoxy and etc. Thin it with 91% isopropyl alcohol to a paintable mixture, not thick. Place a core in the packing. Apply thinned epoxy to the unsanded side of the balsa sheet skins. Locate the trailing edge skin edge on the centerline of the aft spar and the leading edge skin on the centerline of the forward spar. Tape them in place to keep them from slipping out of place. Now flip the whole mess over and apply the skin to the opposite side as stated above. Align the mating packing and place on a flat surface.



8. Check the packing and core for alignment and place a heavy board on it to distribute the weight. One-gallon plastic zip bags, doubled, filled with sand make excellent weights. Allow to cure over night before removing.

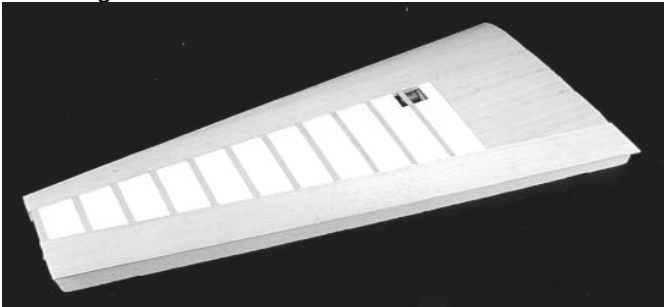

Building Instructions

9. Find the 4 - 3/32" x 3"x 42" sheets. One sheet is required for each side of each panel. Measure out 10" from the root, on the forward spar, and strike a line perpendicular to the spar. Apply the sheeting to this line, starting from the leading edge. Use some of the scrap 3/32" sheet from the leading edge skin trim to fill in the small area left. Use thinned epoxy and hold in place with sandbags or pins. Next locate the 3/32" x 3/8" balsa sticks for rib capping simulation. Cut and fit them at 3" intervals. Use white glue and pin them at both ends until dry.



10. Trim and sand the leading edge sheeting flush with the foam core. Locate and install the 3/8" x 1-3/8" x 48" leading edge. Use white glue and masking tape to hold it in place.

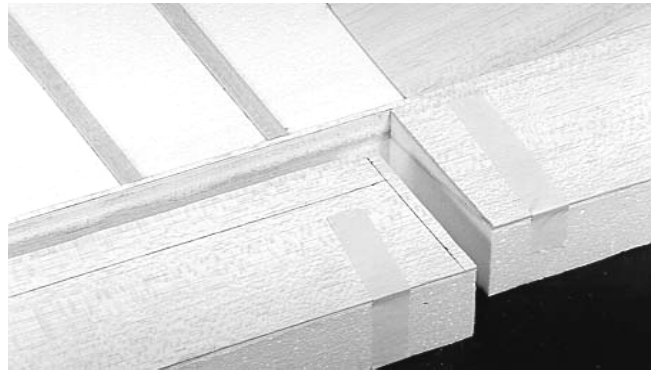

11. Place the foam core in a packing and **tape it in place**. Strike a line at the aft edge of the rear spars on the trailing edge. Measure in 33" from the tip and draw a line perpendicular to the forward spar. Use a band saw if possible, to cut out the aileron. Leave the aileron taped to the packing and remove 7/8" from the leading edge and 1/4" from the inboard end.

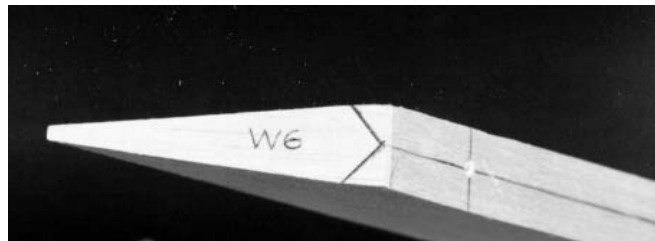

Staudacher S600

12. Cap the aileron leading edge with a 1/2" x 7/8" x 36" balsa stick. Use white glue and tape to hold it. When cured, trim and sand the ends flush with the foam. Also plane and sand the top and bottom flush with the sheeting. Locate (2) W6 and glue one on each end. Sand flush when cured. Locate the four hinge holes, 2" from each end and equally spaced there after. The Robart hole locator is an excellent choice for finding the center and drilling the hole (3/16"). Mark the bevel, 40 degrees, on the end and saw with band saw. The angles can be planed and sanded if no band saw is available.

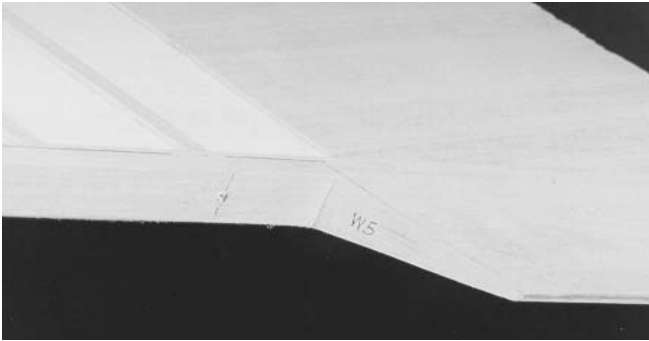

13. Locate W5 and glue in place on the aileron inset inboard end. Cap trailing edge of wing with a 3/8" x 1-1/8" x 36" balsa stick. Use white glue and tape in place. Plane and sand top, bottom, and tip end flush with surfaces. Locate hinge hole centers from the aileron. Note: be careful when planing and sanding the wing trailing edge. You have little surface to work with and it is very easy to damage the capping.



14. Glue on W4 with white glue and tape in place. Sand flush with mating surfaces. Plane and sand the leading edge to the configuration shown on the plans.

Building Instructions

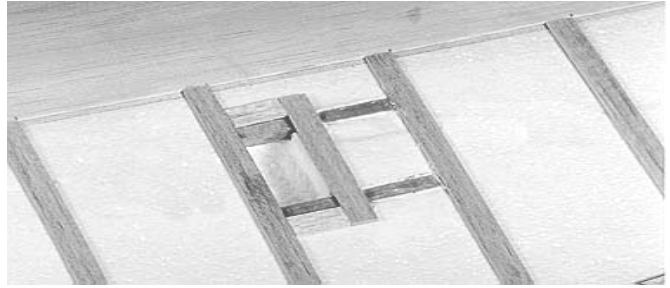

15. Locate the servo well, on the bottom side, in the fifth rib bay from the wing root against the capping and 1" in from the spar. Layout the servo well, 7/8" x 2-5/16", with a ball point pen. Cut around the out side line with a sharp razor. Then use a flat blade screwdriver to dig out the foam to the bottom of the razor cut. Cut and dig some more until the servo fits below the foam surface. Locate the 1/4" sq. hardwood servo rails. Inset these into the foam, flush with the surface, and epoxy in place. Trim the servo opening with 3/32" x 3/8" balsa.

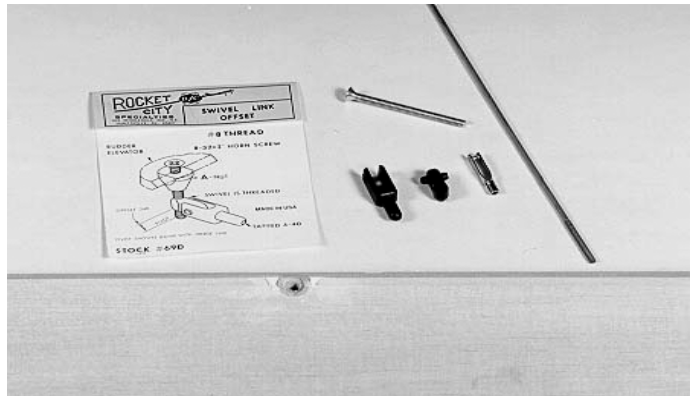

16. With the servo located in the well and the aileron temporarily installed with hinges, mark the point where the pushrod will align with it. Using a drill press and a 1/2" Forstner bit, drill a hole 1/2" back from the leading edge. Make sure the aileron is level, use the packing. Cut off a piece of 1/2" dowel to the required length. Now drill a #19 (.166) hole down through the center of the dowel. Epoxy the dowel in place and sand flush when cured. Countersink the hole on the topside of the aileron to fit the screw head. A 5/16" bit will work. Now run an 8-32 tap down through the hole. We recommend using Rocket City hardware. It's strong and has never failed us.

Staudacher S600

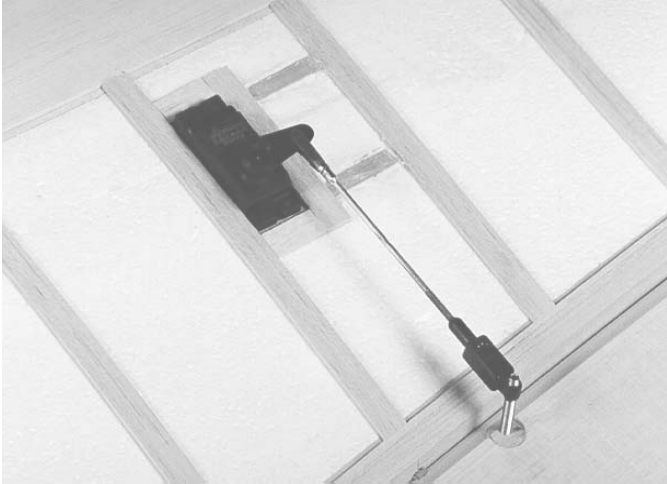

17. Servo mounted and hooked up to the aileron. Access hole for servo lead will be put in later.

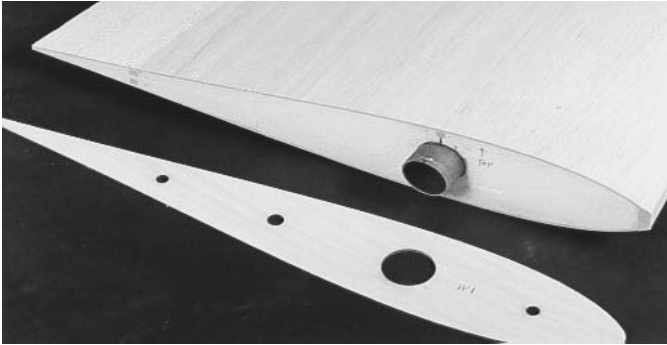

18. Sand off the sheeting at the wing root flush with the foam. Do not sand away much of the foam and change the angle. **Do not install W1** until the fuselage is complete and the wing is fitted to it on the spar. Now build the other wing panel as described above. Rough sand them and set aside for your friends to admire.

FIN/RUDDER CONSTRUCTION

Before starting construction, it is best to gather up all the material needed to build the tail parts. Locate FN1, RUD1, RUD2, RUD3, STB1, STB2 and E1, located on the laser cut 3/16" balsa sheet 5. There are two of these sheets. Finally locate (5) – 1/4" x 3/8" x 36", (4) – 3/8" x 3/4" x 36", (3) – 3/8" x 1" x 36" balsa sticks, short piece of 3/8" dowel and the FIN POST.

1. Lay full size plans on a flat surface and place wax paper over them. Laminate two **STB1's, RUD1's, RUD2's, and RUD3's**, using CA or white glue. Pin down the laminated STB1 and RUD1 on the plans. **Measure, cut and fit the 3/8" x 3/4" and 3/8" X 1"**

balsa sticks around the periphery of the fin and rudder. Pin down to hold them in place. Now glue in RUD2 and RUD3. The laser cut parts leave a charred surface

Building Instructions

and need a light sanding to adhere when glued. Do not take off so much that it changes the original configuration. Just a light touch will do it.

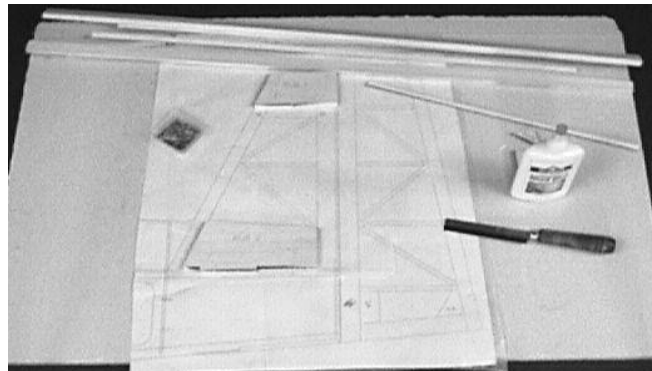

2. Measure, cut, and fit the 1/4" x 3/8" cross and diagonal ribs. Glue them in place with CA or white

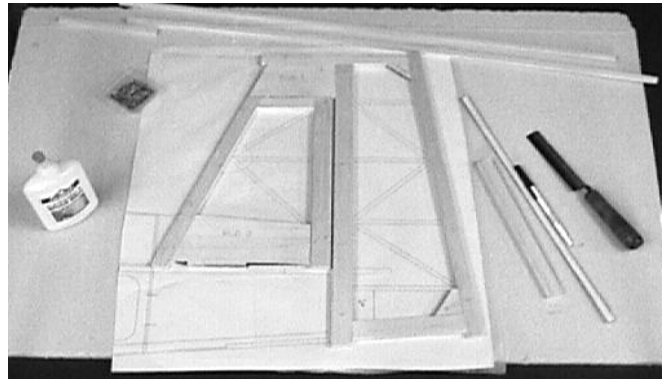

glue. Make good square, tight joints for better gluing surfaces. When a joint is not fitted properly, it takes more glue to secure it. This in turn adds more weight to the model and wastes glue. Spend a little time and make sure the joints fit properly.

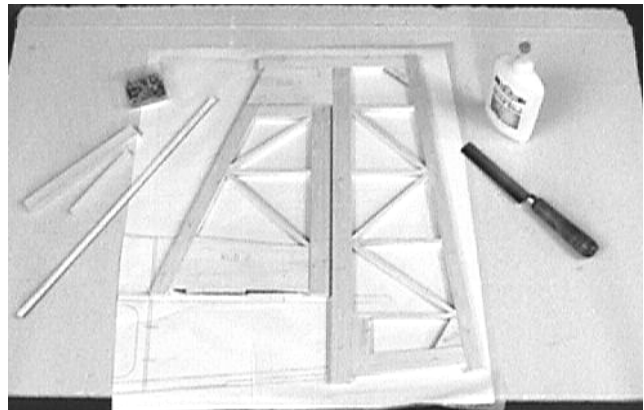

Staudacher S600

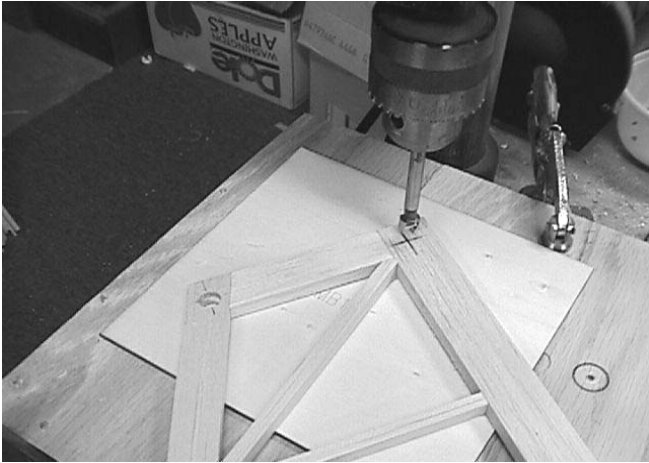

4. Locate the tail bracing hard points from the plans and drill a 3/8" hole, two places, with a Forstner drill bit. Use a backing to ensure a clean break through of the hole.
5. Using the 3/8" dowel, cut off two pieces slightly longer than the thickness of the fin. Epoxy these into the holes with 5-min epoxy. When cured, sand flush with surface on both sides.
6. Drill a 3/32" hole in the center of each dowel to accept a # 2 bolt required for the tail bracing bracket.
7. Lay aside for sanding, shaping, and hinging.

STAB/ELEVATOR CONSTRUCTION

1. Lay the full size plans on a flat surface and place wax paper over them. Laminate two STB1, STB2 and E1, located on the laser cut 3/16" balsa sheet 5 using CA or white glue.

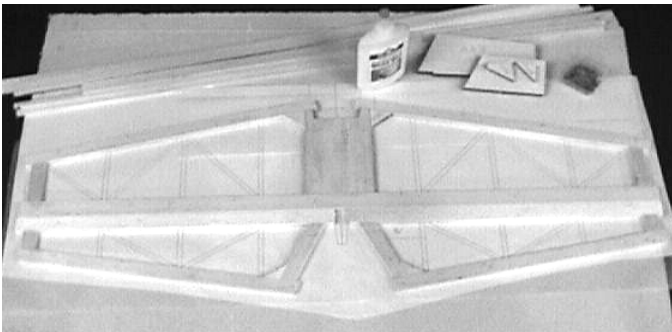

2. Pin down the laminated STB1 on the plans. Measure cut, and fit the 3/8" x 3/4" and 3/8" x 1" balsa sticks around the periphery of the stab and elevators. Pin down to hold them in place. Now glue in the two STB2 and E1.
3. Measure, cut, and fit the 1/4" x 3/8" cross and diagonal

Building Instructions

ribs. Glue them in place with CA or white glue. Make good square cuts assuring better glue joints.

4. When cured, lift the parts from the plans. Locate the tail bracing hard points from the plans and drill a 3/8" hole. 4 places, using a Forstner drill bit. Use a wood

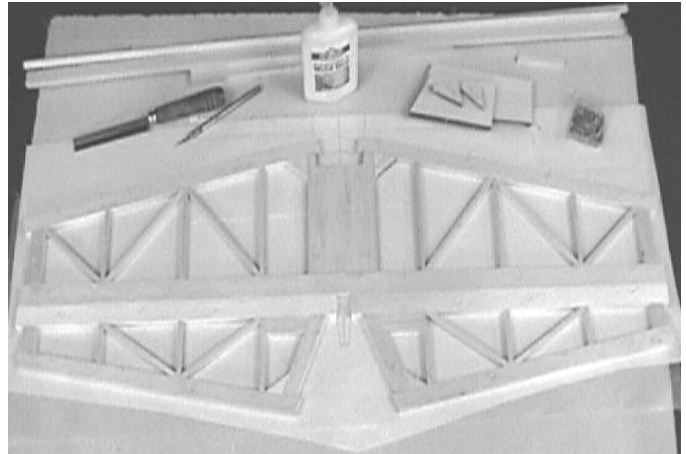

backing to promote a clean break through.

5. Using the 3/8" dowel, cut off four pieces slightly longer than the thickness of the stab. Epoxy these into the holes with 5-min epoxy. When cured, sand flush with surface on both sides.

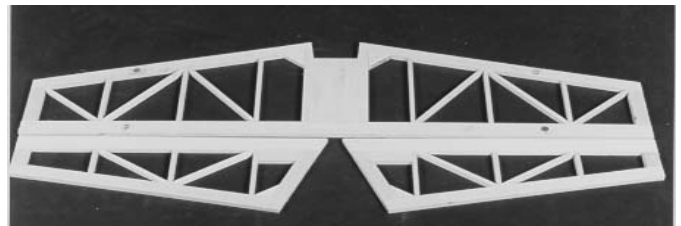
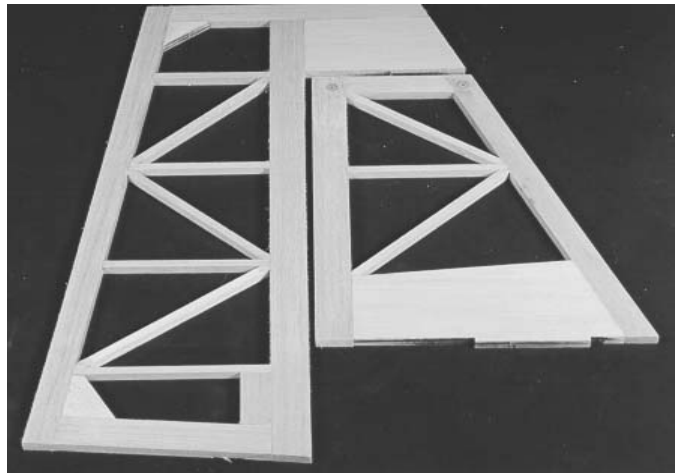

Completed tail parts ready for hinging. Locate the hinge positions as shown on the plans. Drill a 3/16" hole at each location using careful alignment between parts.

Staudacher S600

FUSELAGE CONSTRUCTION

Before starting to build the fuselage it is necessary to prepare the sides, doublers, and top former by removing the excess wood pieces from them. In the lightening holes in the sides, typically use a razor saw and cut one or two of the lands holding the piece in. Now give it a twist. Sand off the stubs flush with the edge.

The tabs and notches in the sides, doublers, and top former are CNC routed and the router bit leaves a small radius instead of a sharp corner. Use a flat file and square up the small radii in all the parts. It only takes a couple of strokes on each one.

Sand the edges to eliminate the fuzz. Determine the outside surface of each side. **Note: the sides are routed with two good sides out.** Lightly sand all the slots for the tabs. The bulkhead tabs go through the slots at a slight angle so it is necessary to give them a light sanding. A piece of hard 1/16" balsa or ply about 1-1/2" wide with 100 grit paper bonded to both sides works well for this application. Generally make sure the sides are well sanded and clean of fuzz. It will save you time later on.

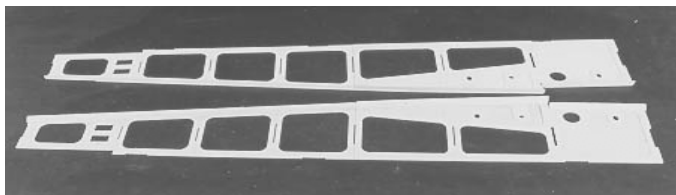

1. Lay the sides out on a flat surface, **opposite hand**, and bond the doublers in place. Align them using the fiber wing spar tube. The fiber tube may fit snug. A quick trip around it with a Dremel drum sander may be necessary. Apply 30-min thinned epoxy to one side of the doubler and align it. Weight it down until cured. Locate the 1/2" tri-stock. Glue a piece along the bottom edge of the side from the end of the doubler to the end of the fuselage. Next glue a piece from the end of the doubler to the landing gear mount notch. And finally, a piece along the top edge of the notch. Do both sides.

2. Lay the top former on a flat surface and pin it down. lit-ply sheet. Cut the micro lands to remove them from the sheet. They could split if you try to pop them out. Place each bulkhead in the slot centering it from side to side. Place wax paper under all the slots where bulkheads are to be inserted. Locate formers F5 thru F8 in the laser cut lite-ply sheet.

Building Instructions

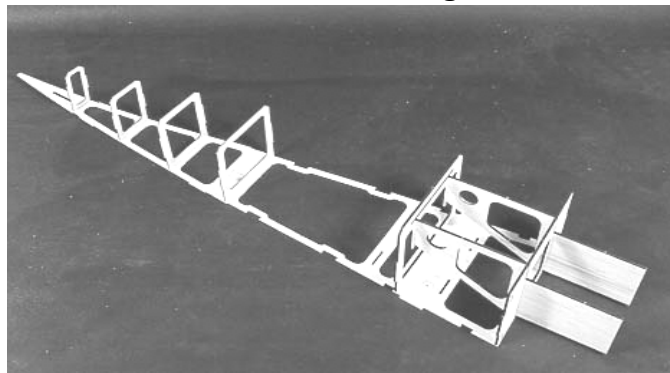

Tack glue, **only at the center**, with thick CA making sure they are all perpendicular. Locate F1, F3, and the two EM1's and remove them from the laser cut lit-ply sheet. Assemble them, in egg crate fashion, and place them in their respective slots. Tack glue F1 and F2 but let the two EM1's float. Make sure F1 is absolutely perpendicular. If you attempt to move the construction at this time to another location for more room to assemble the sides, handle it carefully. The structure is extremely weak between F3 and F5. Pick it up holding on to F5 and F1.

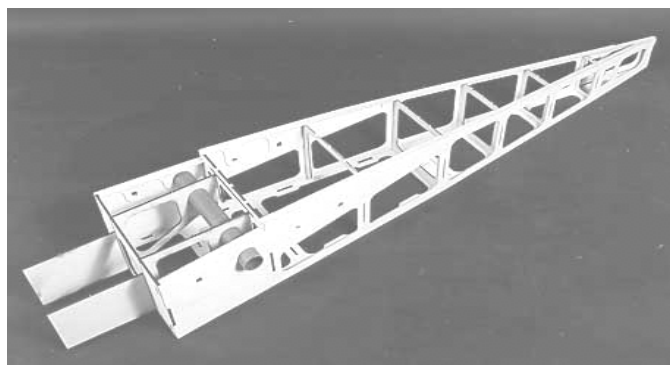

3. Trial fit one side to check assembly with bulkheads. Some sanding may be necessary to make the tabs insert into the slots because they go through at a slight angle. When satisfied with the fit tack glue each bulkhead to the side and the side to the top former in the middle of each side bay. Make sure the tabs are inserted completely into the slots. Now bring in the other side and trial fit as described above. **Don't forget to install F4!** Before tack gluing in place, slip the fiber wing spar tube through the wing spar hole to align the two EM1's with the sides. Here again it might be necessary to open up the holes in the two EM1's and the sides. The tube goes through the sides at an angle. Tack glue the side on. Glue in the fiber tube. Now load your glue gun with white glue and lay a fillet of glue around all the joints, and both sides of each bulkhead.

Staudacher S600

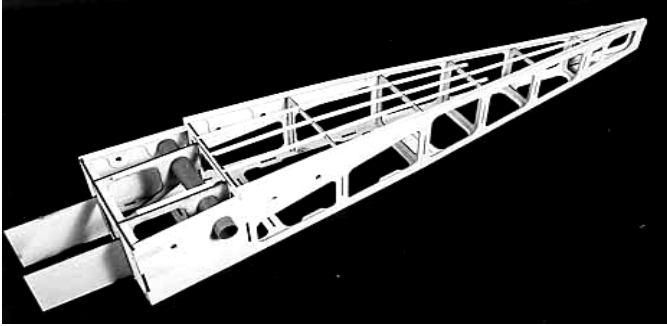

3. Locate the 48", 1/4" sq. balsa stringers. Install them, as shown in the photo, on the bottom of the fuselage. The long center stringer ends at bulkhead F8.

4. Cut several pieces of 1/2" tri-stock and glue them in as shown in the photo. Even though the long pieces glued on the inside of the EM1's are not glued in total to the landing gear mount, they act as stiffeners spreading the load and strengthening the engine mounts.

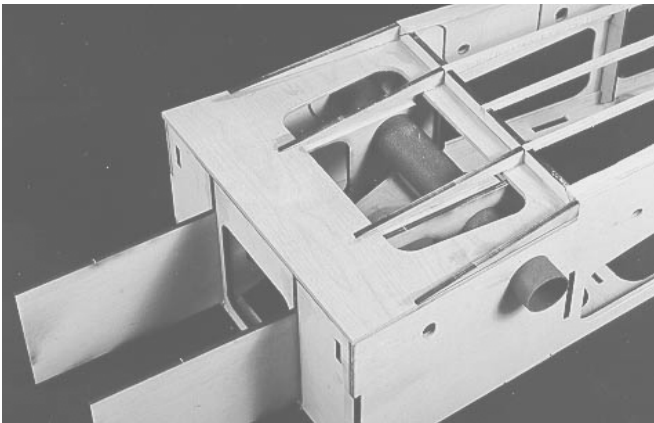
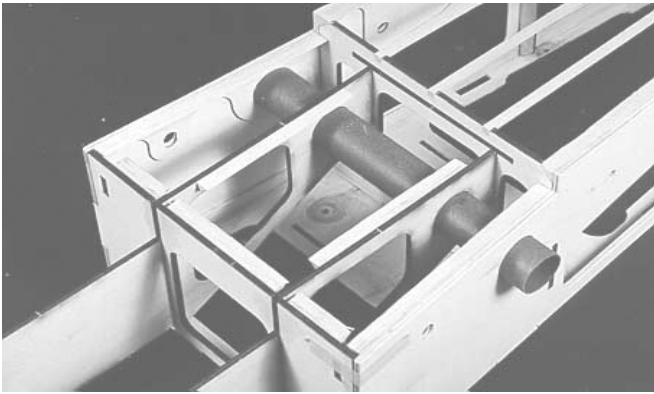

5. Find the landing gear mount LG1 and epoxy in place. Always trial fit first before gluing. Tape in place until cured. Cut out the four LG2's and epoxy them flush with the sides. Space the two center ones directly over the engine mounts.

Building Instructions

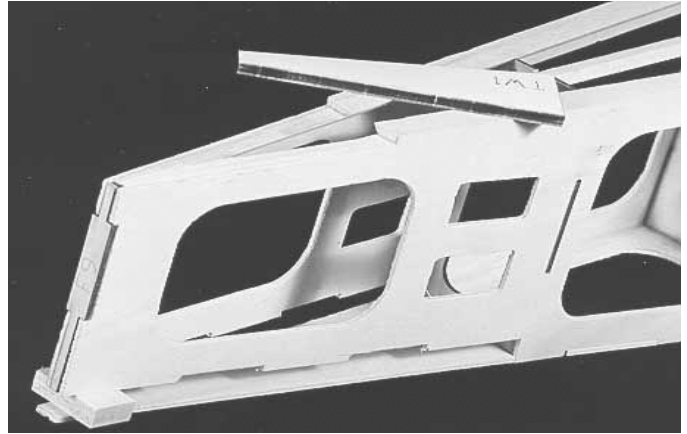

6. Notch out the 1/2" tri-stock flush to the edges of the fuselage sides. Glue in F9. Epoxy in TW1 and tape it in place until cured.

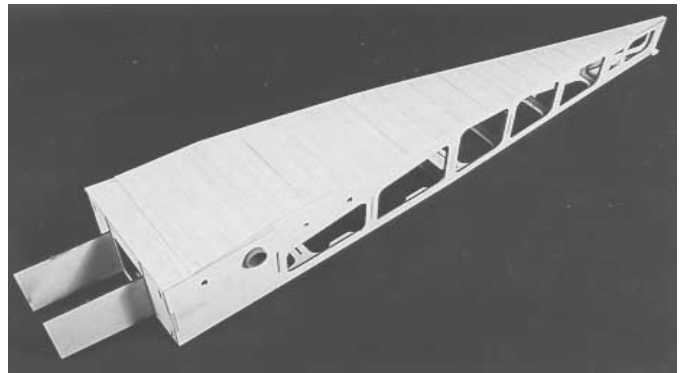

7. Sheet the entire bottom with 3/32" balsa sheet. Start at the forward edge of F3 and work back. Glue with thick CA. Now sheet the section over the landing gear mount.

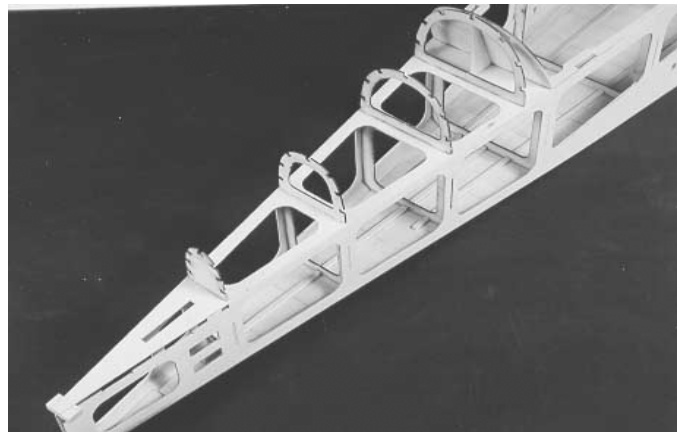

8. Cut out bulkheads F5A, F5B, F6A, F7A, F8A, and the brace from the laser cut sheet. Glue them into the slots provided centering them side to side.

Staudacher S600

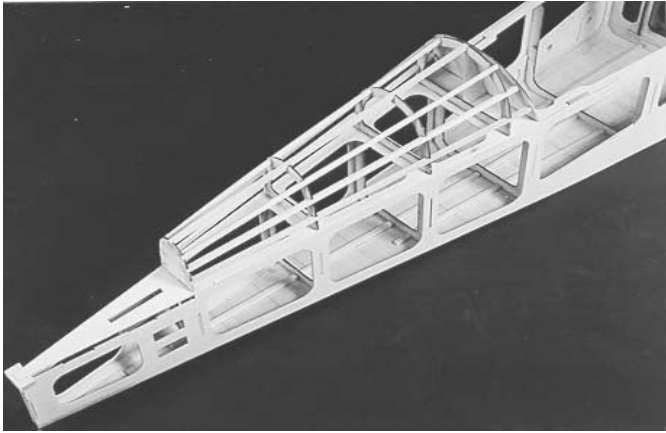

9. Glue in the 1/4" stringers starting with the top center one. Just butt the stringers against F5A and glue. After stringers are installed sand the edge of F5A to conform with the slope of the turtledeck.

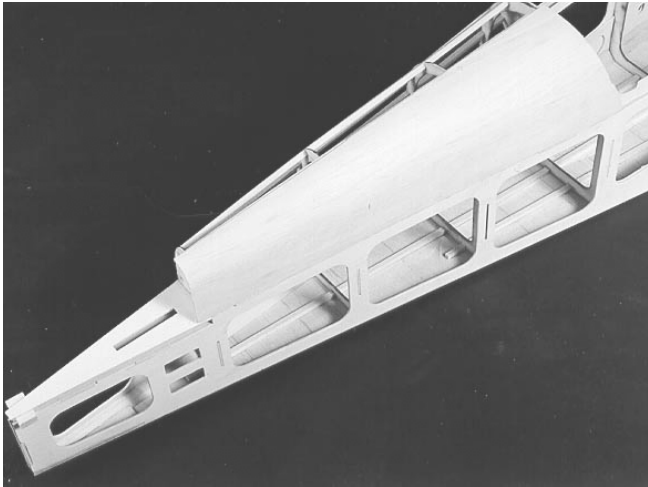

10. Locate two 3/32" x 3" x 48" balsa sheets and cut them in half. Edge glue two sheets together using thick CA. Now do the other two. Block sand both on one side. Add a small piece of sheet at the end near F5A, 1-1/2" x 5". Cut from the scrap piece removed from the wing leading edge. Edge glue one sheet against the formers to the top of the fuselage using thick CA. Mix ammonia with water and dampen sheet until it will form around curve. Apply thick CA on the stringers to the area to be glued. Form over and hold the sheet in place until cured. Sand both ends flush with the formers. Locate and install FT2 in the lower surface of the stab slot

11. Lay some wax paper over the edge of the forward section.. Find formers F1A, and F2 in the laser cut 1/4" lite-ply sheet. Locate them in their respective slots. Lightly tack glue F1A and F2 in place. **Note: make sure that both formers are square to top fuselage former and F1A is flush and in the same plane with F1.** Cut

Building Instructions

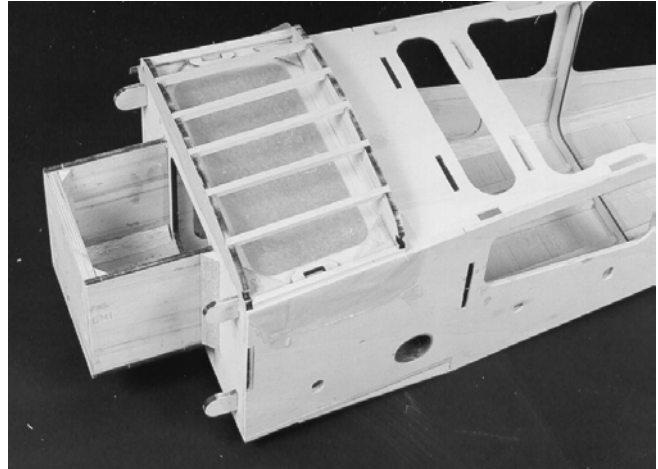

two 1/4" sq. hardwood rails and glue them in between F1A and F2 on each side. They should be offset from the sides by 3/32". Find two C5's and glue them to the rails, centered over the square hole in the top former. Next, glue in the C3 and C4 gussets. Use a 1/8" shim under each to locate them flush with the rail. Locate the 1/4"sq. balsa sticks and glue in the stringers. Sand the ends flush with the formers.

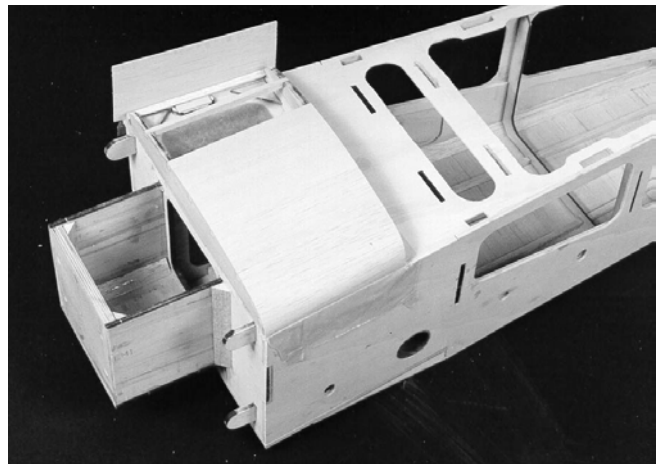

12. Select 3/32" sheet balsa that is straight grained to make the sharp bend on the sides. Make all the joints fall on a stringer. Cut a length of 3/32" x 3 sheet and glue it ,with thick CA, to rail flush with fuselage side. Mix ammonia with water and dampen sheet until it will form around curve. Apply thick CA on the stringers to the area to be glued. Form over and hold the sheet in place until cured. Make the sheet joints fall on a stringer for better support when gluing.

Staudacher S600

13. Cut out two C6 from the Laser cut 1/4" lite-ply sheet. Epoxy them into the slots on C5. Note: glue a scrap piece of 3/32" sheet on the top of each C5. This will allow C6 to be inserted at the proper depth.

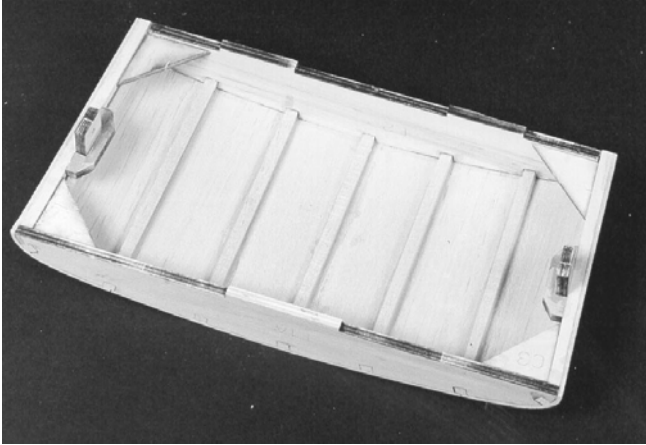

14. Locate the center of each C6 on the side of the fuselage with a mark. Add a piece of scrap 3/32" sheet shim to the outside face of each C6. Tape the hatch in place. Measure down 3/8" from the top of the fuselage side drill a #25 (.150) hole thru the side and C6. Remove hatch and drill out the #25 holes with a 3/16" drill. Install the blind nuts with the flange facing out. CA around each flange to retain. More shimming may be necessary to center the hatch.

CANOPY CONSTRUCTION

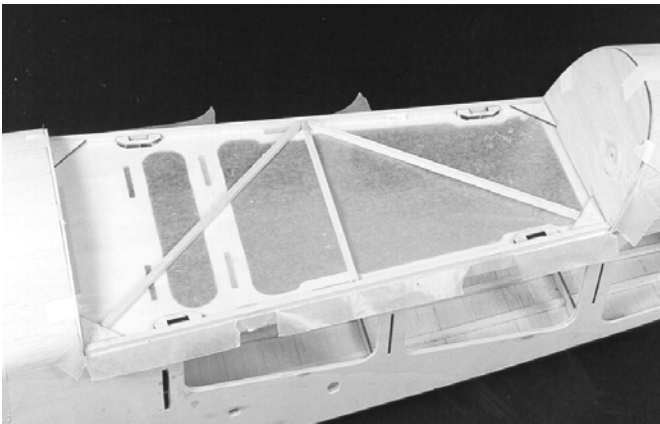

1. Tape C1 to F3A and C2 to F5A. Both formers should be offset in (smaller) slightly by approx .040. If not, make them conform. Lay down wax paper along the fuselage side rails. Cut, fit, and glue in two 1/4" sq. rails between C1 and C2. Inset them in from the fuselage side .040 to allow for canopy thickness Glue in the 1/4" sq. hardwood cross brace. Cut, fit, and glue in the 1/4" sq. balsa diagonals. Install the C3 and C4 gussets. A scrap piece of 1/8" sheet under each will bring them to the proper height. Locate the four C5. Glue in with the slot centered over the slot in the fuselage top.

Building Instructions

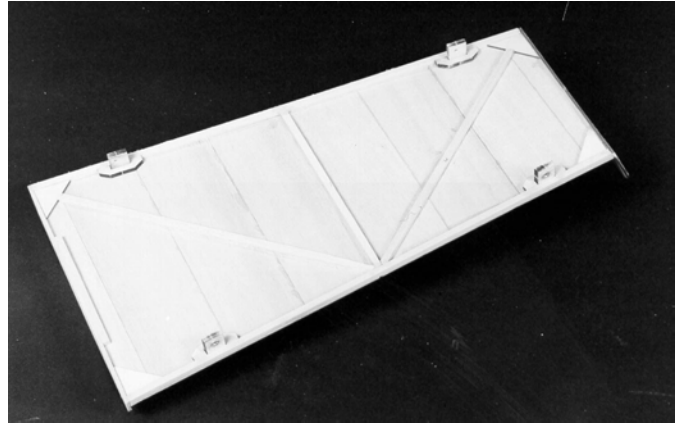

2. Sheet the top of the canopy base with 3/32" sheet. When cured, sand flush on both sides. Cut out four C6 from the laser cut 1/4" lit-ply sheet. Epoxy them into the slots on C5. Make sure they are aligned properly.



14. Locate the canopy and cut the ends out of it. **Do not remove more than the end pieces.** Mount the canopy base and tape it in place. Lay the canopy over the base and align. Now tape in place. Mark around the periphery of the base with a felt tip pen. Remove and trim off the excess. Re-mount the canopy. Of course it doesn't fit. Keep trimming until it does. This is hard to do so take your time and make sure of a good fit.

When satisfied with the fit, lay it aside and think about how you are going to finish the interior. **Note: when gluing on the canopy, make sure the base is mounted on the fuselage and the formers at both ends are lightly taped against their adjacent formers.** This is a requirement for a good fit. Locate, drill, and install the blind nuts as stated on page 9, step 14. When mounting the base to glue on the canopy, install all four hold down bolts

LANDING GEAR

Staudacher S600



1. Layout the holes to mount the landing gear noting the dimensions shown on the plans. Holes for the wheel pants retaining bolts will also have to be drilled. Locate these holes $\frac{3}{4}$ " from the axle hole on the centerline. Use a #28 drill to drill one hole in each strut.

WHEEL PANT CONSTRUCTION

1. Locate the wheel pants and pair them up. You will need to make a LH and RH. Lightly sand the edges with a flat sanding block. Tape the halves together, aligning the edges, and apply thin CA along the seam where possible. Remove tape and finish gluing.

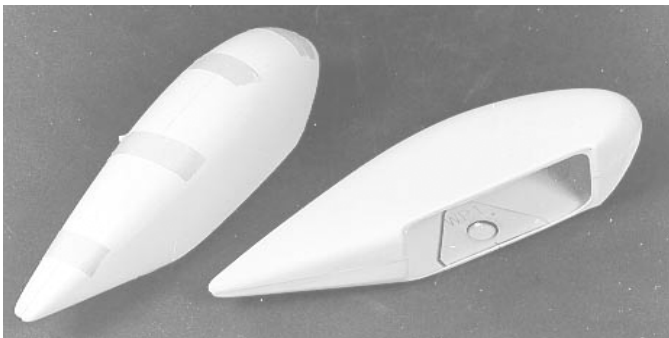

2. Cut out the opening in the bottom of the pant to allow clearance for the wheel. Use a Dremel Motor with a drum sander.

3. Cut a strip of 2 oz glass cloth approx. 1" wide, and place it on the seam on the inside of the pant. Using Ace Hardware General Cement, paint it in place with the cement dauber. Do both wheel pants.

4. pant. Now remove the plastic inside the hole in WP1. Note the se Locate the two WP1 and round off the bottom edge

Building Instructions

to fit the pant. Find the center of the wheel opening and thick CA in place. Remember to make a LH and RH ction of the wheel and pant on the plans as you proceed to the next step.

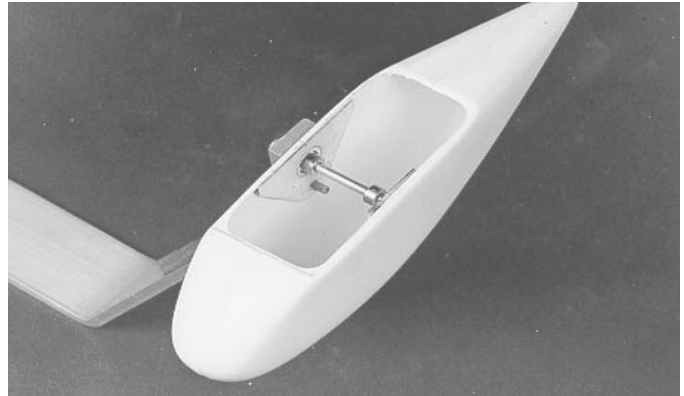

5. Locate the gear and install a wheel axle. Slide a wheel into the pant opening and slip the wheel and pant together on the axle. The hole in the pant should fit over the hex on the axle.



6. Mount the landing gear on the fuselage and block up the tail to flying position. Position the wheel pant so that it's level and match drill a $\frac{5}{32}$ " hole from the hole in the landing gear. Remove the wheel pant and install a 6-32 "All Thread" insert on the inside of the pant. Reassemble the pant and wheel with a WP2 mounted on the end of the axle. Secure with a 6-32 Soc. Hd. bolt with lock washer and plastic flat washer. Orient WP2 to fit against the side of the pant and thick CA in place. Note: when installing the pants after painting, use the wheel collars to space the wheels as shown on the plans.

COWL CONSTRUCTION

Staudacher S600

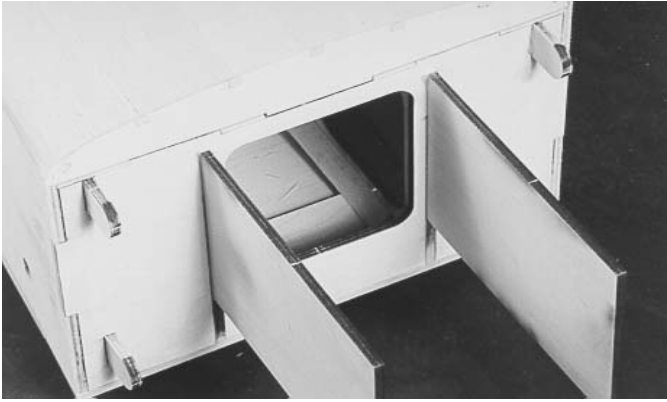

1. Find the four CW2 cowl retainers. Epoxy into the four square holes in F1, flush with the back surface. Before the epoxy is completely cured, slip the cowl ring over them to make sure of a snug fit.

2. Laminate four CW1 retainers together with thick CA. Square up the ends to eliminate the char from the laser cutter. Slip the cowl ring over the CW2 retainers and tape in place. Now epoxy a laminated CW1 next to each

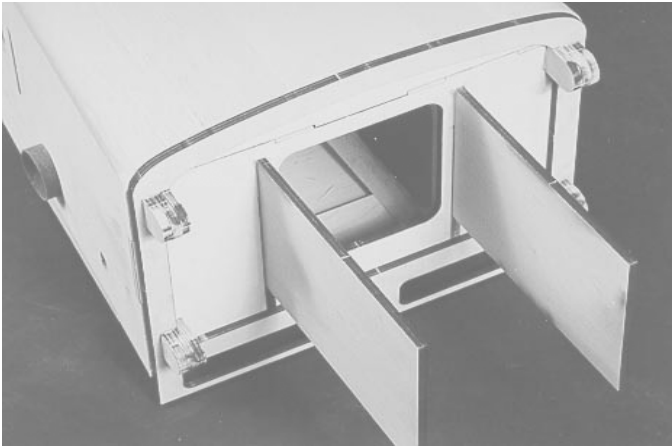

of the retainers. Apply epoxy to the outside edge of each CW1 so as not to glue them to CW2.

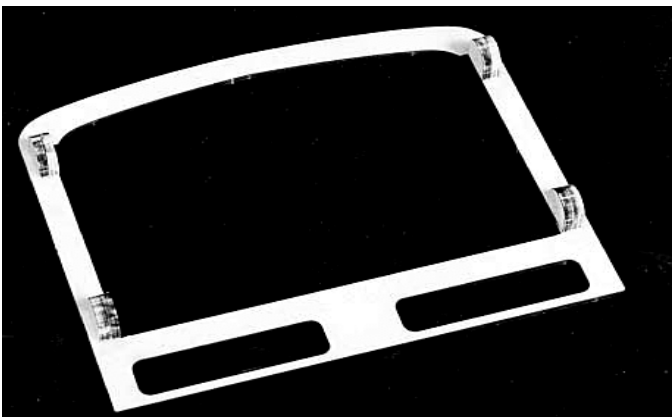

Building Instructions

3. Remove ring before epoxy has completely cured and then re-glue around the outside edges.

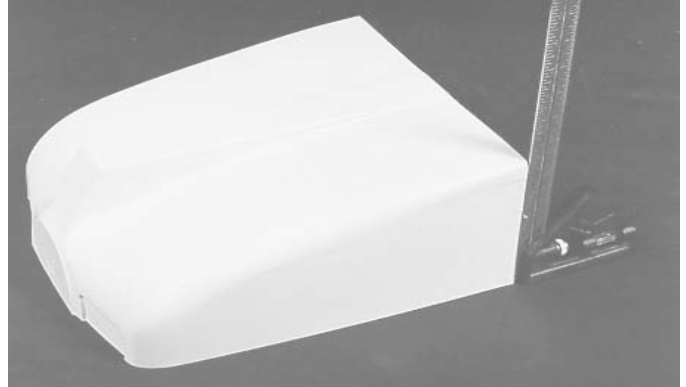

3. Locate the two cowl halves. Trim off the back edge of each 13-3/4" from the spinner ring. Best way to do this is, lay the cowl half on the floor next to a flat door. Position the spinner ring squarely against the door. Now measure from the door surface at various places around the cowl. Strike a line and trim to it. **The back edge must be square to the floor.** Now do the other one.



4. Place the cowl ring assy. on a flat surface with wax paper and pin or weight it down. Place the top cowl half over the ring holding it firmly against it. Thick CA glue it all the way around on the inside.

Staudacher S600



5. Glue in the cowl ring, CW5, with thick CA glue on the lower half cowl.

6. Lay the cowl, as assembled, on its side on a flat surface with wax paper. Place the lower half against the ring flush with the back edge. Work from the back. Glue it in the center. Make sure the ring in front is tucked inside the top half. Now glue the bottom half with thick CA glue all the way around. Bring the spinner ring together and glue it to the top half. Tack the front edges together all the way across the front. Cutting out the air

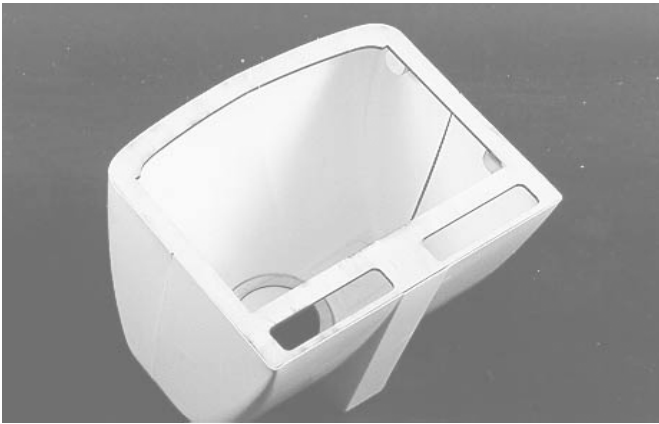

vent holes will make it easier to align. Lay the cowl on its side on a flat surface. Find CW4 and spread some thick CA on one side. Center it over the seam, inside, between the top and bottom cowl halves and against the cowl ring. Now, do the other side.

7. Apply Bondo to cover the seams on either side and in front. Clean up the air vent holes and the spinner ring hole. The large hole in the bottom is for carb and muffler pipes. Depending on the engine you use the configuration may change. The Former CW3, at the

Building Instructions

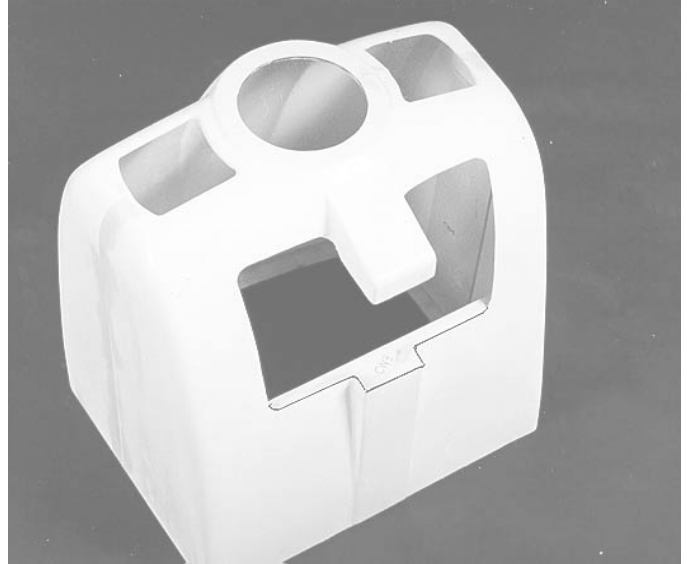

bottom is installed for added stiffness. In all cases please install it. Fiberglass the inside surface with 2 oz cloth using Ace General Cement. **Do not put on heavy coats.** When cured, give it a thin coat of epoxy. See plans for cowl mounting/securing info.

TAIL FILLET BLOCK CONSTRUCTION

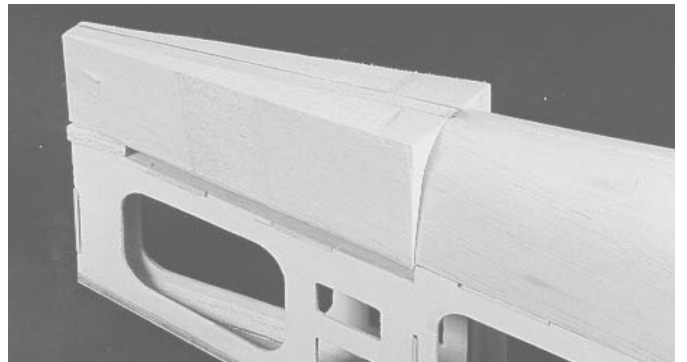

1. Locate the dummy fin and fillet parts on sheet 9. Laminate each with thick CA glue. Find the two large balsa blocks and trace the outline of the dummy fin on the surface of each and saw out. This will give you the profile required. Tack glue the parts together with the dummy fin in the center. Align the block on the **centerline** of the fuselage and mark the fuselage configuration on the bottom side. Saw to shape and tack glue on fuselage.

Staudacher S600

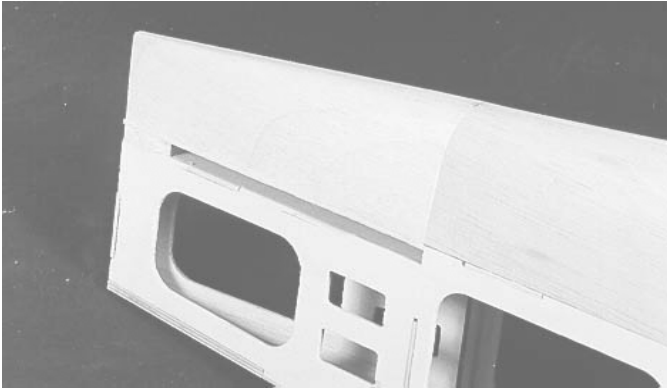

2. Shape the block to fit the fuselage. A small piece of 3/8" balsa tack glued in the stab slot will help hold things solid. When cured cut apart

3. Glue the Fin Post on the back edge of the fin. Slide the fin in place and tape the Fin Post to the back of the fuselage. Now fit the Fillet in place and glue with thick CA. When covering, cover the tail blocks separately leaving a 1/8" flange all around them. Then glue block in place and iron flange down with trim iron. This is a great method used to hide the joint between the parts.

Hinge the fin and rudder as stated in the Wing Construction section, step 12. Also hinge the elevators to the stab. If you are one to install many hinges,

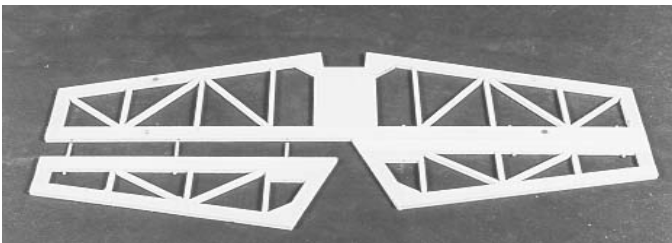
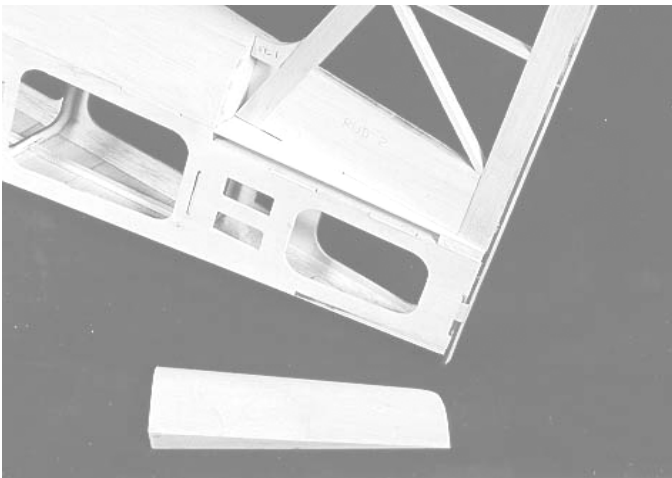

Building Instructions

then add more hinges. We have test flown this model with those shown with no adverse results. It's your choice. Use epoxy to install them.

GLUING ON W1 WING ROOT

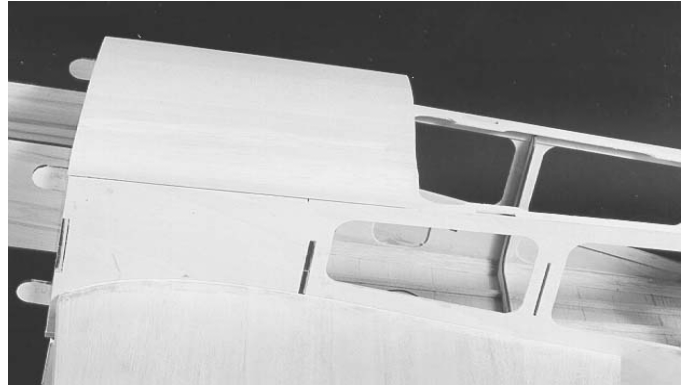

1. Place the aluminum wing spar in the fuselage. Make sure the sheeting and spars are flush with the foam wing root. Cut off the fiber spar tube so that it protrudes 1/8". Place the W1 root cap on the wing and slide the wing on to the spar up against the fuselage. Check the fit. It may not fit perfect all along the rib and wing. Apply epoxy where it does fit well against the wing. Now, pin W1 against the fuselage all around. Where there is a gap fill with a thick paste of micro balloons and epoxy. You have now custom fitted the wing to the fuselage. Do both wings. When cured, trim W1 flush with the wing sheeting.

GLUING IN THE ANTI-ROTATION PINS

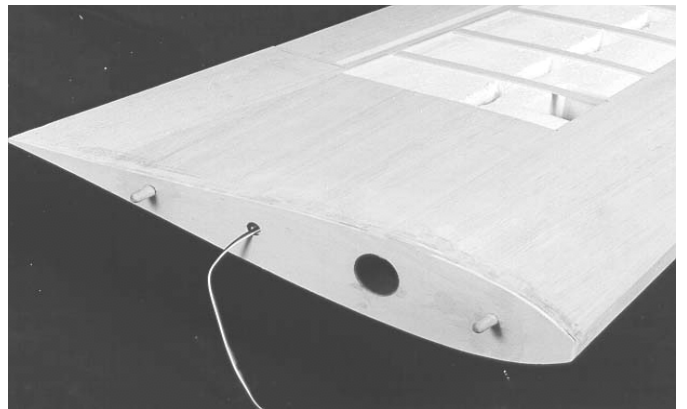

1. Locate the four 3/8" x 4" dowel. Round off one end and sharpen the other end. These dowels must go in parallel to the wing spar **not the end rib surface**. To ensure they go in at the right angle, drill a 3/8" hole in a 2" piece of 2 x 4 near one end. Cut a 5-degree angle on the opposite surface. This will be your drill guide.

Staudacher S600

2. Now drill the holes in foam holding the guide flat against W1. Make sure you have it orientated properly. Apply epoxy to the dowel, insert it in the hole leaving $\frac{3}{4}$ " extended. Carefully slip the gauge over the dowel to be ensure the angle is correct before the epoxy cures.

SETTING THE WING INCIDENCE



1. With the aluminum wing spar mounted in the fuselage, slide the horizontal stab into the slot at the tail. Block up the tail so the stab is level (in flying position). Carefully slide the wings on the spar and against the fuselage. Using a Robart Wing Incidence Indicator, zero out the wing and pin or tape it in place. Now locate a W7, and epoxy it in place over the $\frac{3}{8}$ " dowel taking care not to move the wing. When cured glue the other W7 in place over the forward wing dowel. **This is important and will adversely affect the flying of your model if both wings are not in the same plane or, have too much positive or negative incidence**



WING SERVO LEAD PASSAGE

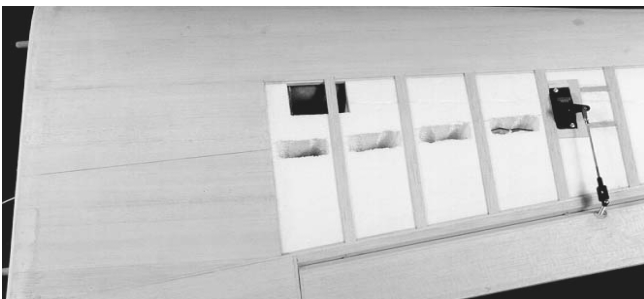

Building Instructions

1. It's a chilling thought to think you can push a stiff wire through the foam and have it end right at the servo well. To make this task easier, layout a line on the wing surface where you want it to go starting from the center of the $\frac{1}{2}$ " hole in W1. Cut out slots, through the foam, in each rib bay 1" wide. Using a piece of stiff music wire, force it through the foam from W1 to the first slot in the foam. Now enlarge the hole to approx. $\frac{1}{2}$ ". Use the stiff wire again to put holes through each joint until you reach the servo well. Now enlarge these holes. The beauty of this method is, you can see what you are doing, that is most of the time.

MOUNTING THE ENGINE

1. When mounting the engine you must first determine the distance from the engine-mounting surface to the spinner back plate. Subtract this from the cowl length. The difference, plus the clearance between spinner back plate and cowl, is the dimension needed to cut off the EM1 engine mounts. Use a square and strike a line on each one. Use a razor saw to trim them off.

2. Locate the $\frac{1}{2}$ " x 5" x 6" firewall and layout the engine mounting holes and install the $\frac{1}{4}$ -20 blind nuts. The distance from the top of the firewall to the thrust line is 2- $\frac{5}{8}$ ". If you decide to use side thrust, the engine should be shifted to the right side, facing it, approx .450 on the centerline to give a 3 degree offset. In this case the spinner will be centered in the ring but you will have to allow more distance between the cowl and the spinner backplate. Some fine shimming will be required

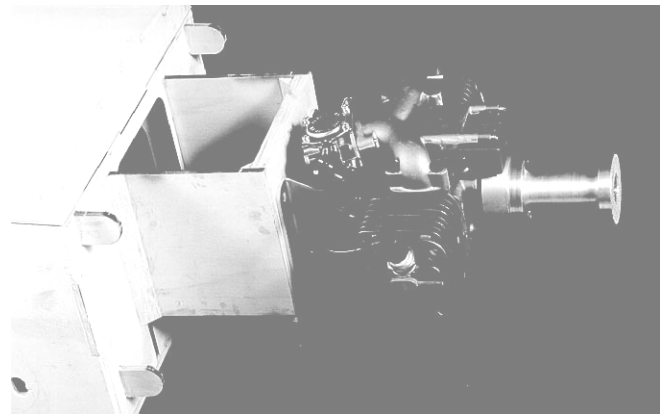

Staudacher S600

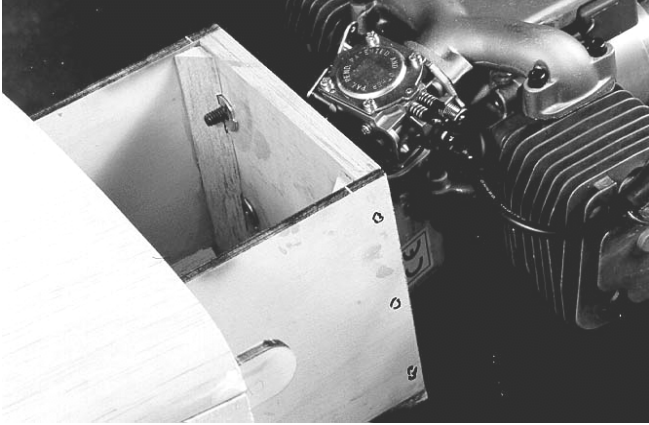

2. Epoxy in the firewall flush with the two EM1's. Cut ,fit, and epoxy in the 1/2" tri-stock bracing on the sides ends and bottom. Using the 1/8" dowel, cut 6 pins, 3/4" long and pin the sides to the firewall using epoxy. Locate the two MB1's, trim the length to fit, and epoxy them on the top and bottom of the motor box.

FILLER BLOCK

1. Behind the stab it will be necessary to fill in the slot with a filler block. Temporarily install the stab in the slot provided in the fuselage. Locate a scrap piece of 3/8" x 1" balsa, left over from building the tail parts, and trim to fit the open space. When installing the stab, after it has been covered, cover the edges of the filler block before epoxying it in place.

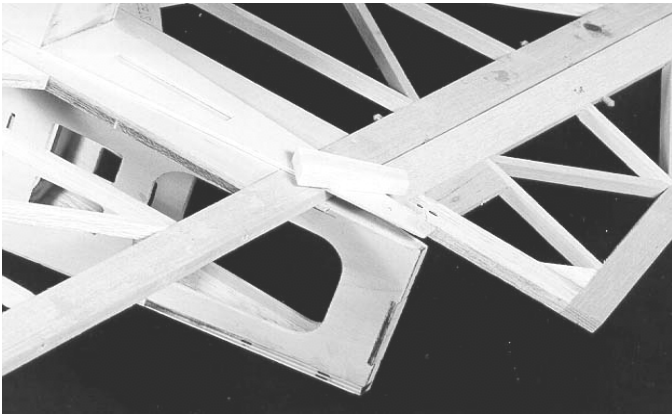

FINISHING AND RADIO INSTALLATION NOTES

1. We leave the covering and finishing up to you and what you have had experience with. In order to keep your Staudacher as light as possible we recommend you cover it with a film covering. Keep the paint down to a minimum, also heavy decals. With extra power up front you can cover it with Super Coverite or Super Shrink and paint it making the model more durable. But, expect it to weigh more. Keeping the model light will give you added performance with lesser power.

Building Instructions

2. Our prototype's were covered with UltraCote with cowl and wheel pants painted. In the interest of keeping your Staudacher as light as possible, you might consider covering it with one of the popular film coverings. We recommend using Fommla U. K&B Superpoxy, Hobbypoxy, Perfect Paint, Coverite 21st Century or MonoKote paint over the ABS plastic. Do not try to mix different paints and thinners together and by all means test a small piece first before using any other paint not listed.

3. Install the radio and batteries up forward. Wrap them in foam and tie them down to keep them from wandering around. You have plenty of room to shift them forward or aft to help offset any balance problems. The same for the fuel and smoke tank, if you decide to use one.

4. Make up the pushrods as shown on the plans. We have shown 4-40 threaded rods and hardware for stiffness. Use them for better control response. We recommend you install 70oz. servos or larger on all the control surfaces. A smaller servo can be used on the engine throttle. Install it where necessary to accommodate the engine of your choice.

PRE-FLIGHT NOTES

Before the first flight, and to ensure some longevity in your Staudacher, you will do well to check out a few things before heading to the flying field.

1. Balance the Staudacher at the indicated CG point shown on the plans with the fuel tank empty. Depending on your type of flying you may want to adjust it forward some.

2. Check the control surface travels. We have given you a starting point however, they need to be fine tuned to meet your flying needs.

3. Run the engine and check the idle. Have it ready so you don't encounter any problems at the field.

4. Turn on the radio with the engine running to make sure there are no intermittent glitches. Give it a good range check.

5. Check all hardware to be sure it is secure. There is nothing worse than losing an airplane on the first flight because of a lose nut or clevis.

Staudacher S600

7. Hopefully by now you are ready. We know you will be thrilled with your first flight and that it will be most successful. From now on - Happy Fly'in!

Jerry Smith

Building Instructions

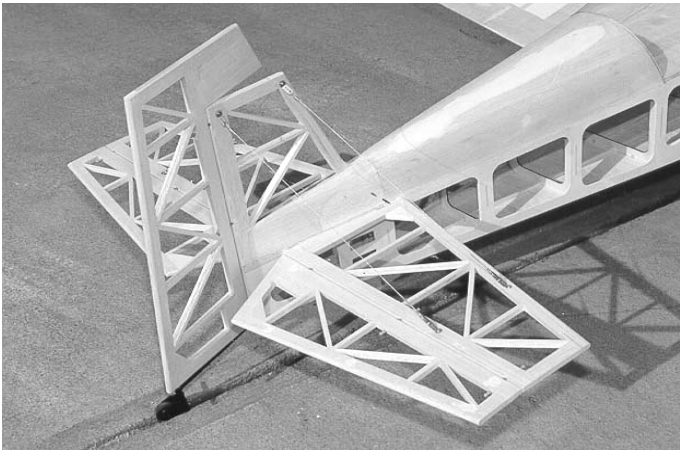
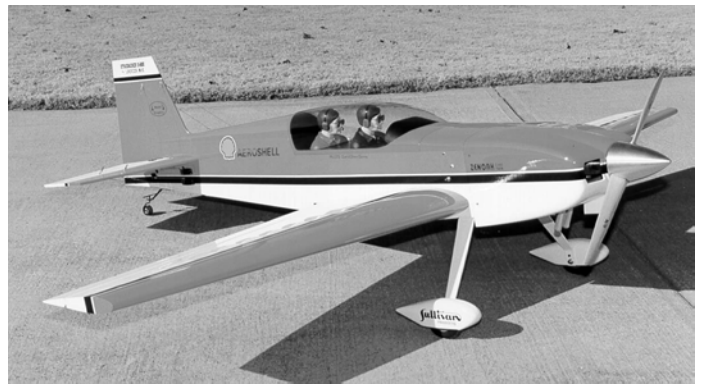

MATERIAL LIST

FUSELAGE

lc = Laser cut cnc = Router cut

1. FS1 (2) cnc, (fuselage side)
2. FT1 (1) cnc, (fuselage top)
3. FD1 (2) cnc, (fuselage side doubler)
4. LG1 (1) cnc (landing gear mount)
5. EM1 (2) lc, (engine mount)
6. MB1 (2) lc, (engine mount top and bottom)
7. F1 (1) lc, (fuselage bulkhead)
8. F3 (1) lc, (fuselage bulkhead)
9. F4 (1) lc, " "
10. F5 (1) lc, " "
11. F5A (1)lc, (fuselage former)
12. F5B (1) lc, (fuselage former)
13. F6 (1) lc, (fuselage bulkhead)
14. F6A (1) lc, (fuselage former)
15. F7 (1) lc, (fuselage bulkhead)
16. F7A (1) lc, (fuselage former)
17. F8 (1) lc, (fuselage bulkhead)
18. F8A (1) lc, (fuselage former)
19. F9 (1) lc, (fuselage bulkhead)
20. LG2 (4) lc, (landing gear mount former)
21. TW1 (1) lc, (tail wheel mount)
22. FT2 (1) lc, (tail end reinforcement)
23. BRACE lc, (1) (support for F5A)
24. FD2 (8) lc, (servo mount reinforcement)
25. Fuel tank mount (1) lc, (tank support)

WOOD STOCK

- (5) 1/4" X 1/4" X 48" balsa stick, (fuselage stringers, canopy base braces)
- (4) 3/32" x 3" x 48" balsa sheet, (fuselage bottom and turtledeck)
- (1) 3/32" x 3 x 36" balsa sheet, (fuselage bottom)
- (5) 1/2" x 36" tri-stock. (fuselage bottom rail, fwd. bracing)
- (1) 1/8" x 6" dowel, (firewall pinning material)
- (1) 1/2" x 5" x 6" A/C ply, (fire wall)

MISC.

- (1) 18" fiber tube, (wing spar support)
-

WING

Wing foam cores (LH and RH)

1. W1 (2) lc, (root wing rib)
2. W2 (2) lc, (wing spar support)
3. W3 (2) lc, (wing spar support)

4. W3A (2) lc, (wing spar support)
5. W4 (2) lc, (wing tip cap)
6. W5 (2) lc, (wing aileron inset cap)
7. W6 (4) lc, (aileron end cap)

WOOD STOCK

- (2) 3/8" x 1-3/8" x 48" balsa, (leading edge)
- (8) 3/32"x 3" x 48" balsa sheet, (leading edge)
- (8) 1/4" x 1/4" x 48" spruce , (wing spars)
- (4) 3/32" x 4" x 48" balsa sheet, (wing trailing edge)
- (2) 3/8" x 1-1/8" x 36" balsa, (wing trailing edge)
- (2) 1/2" x 7/8" x 36" balsa, (aileron leading edge)
- (4) 3/32" x 3" x 42" balsa sheet, (wing center section)
- (4) 3/8" x 4" hardwood dowel, (wing anti-rotation pin)
- (1) 1/2" x 6" hardwood dowel, (control horn)
- (9) 3/32 " x 3/8" x 36" balsa (wing capping)
- (1) 1/4" sq. x 16" spruce, (servo rails)

MISC

- (1) 1-1/2" x 36" OD aluminum wing spar with fiber tube
 - (2) foam wing cores (LH and RH)
-

TAIL

1. STB1 (2) lc, (fin base)
2. RUD1 (2) lc, (rudder tip)
3. RUD2 (2) lc, (gusset)
4. RUD3 (2) lc, (gusset)
5. STB2 (2) lc, (horizontal stab center)
6. STB3 (4) lc, (gusset)
7. E1 (4) lc, (gusset)
8. Dummy fin (2) lc, (used in place of fin between tail blocks to form fairings)
9. Fillet (2) lc, (fin fillet with fuselage)

WOOD STOCK

- (5) 1/4" X 3/8" X 36" balsa (cross and diagonal bracing)
 - (4) 3/8" x 3/4" x 36" balsa (Outline of stab, rud, and elev)
 - (3) 3/8" x 1" x 36" balsa (stab, rud., and elev. Leading edge)
 - (2) 1-1/4" x 3-1/4" x 9-1/2" balsa block (fin, fuselage fairing)
-

FORWARD HATCH

1. F1A (1) lc, (hatch former, front)
2. F2 (1) lc, (hatch former , back)
3. C3 (2) lc (gusset)

4. C4 (2) lc (gusset)
5. C5 (2) lc (retainer block reinforcement)
6. C6 (2) lc (retainer block)

WOOD STOCK

- (2) 1/4" x 1/4" x 48" balsa stick, (hatch stringers)
 - (1) 3/32" x 3" x 48" balsa sheet, (sheeting)
 - (1) 1/4" x 1/4" x 24" spruce, (hatch rails)
-

CANOPY

1. C1 (1) lc, (front former)
2. C2 (1) lc, (aft former)
3. C3 (2) lc, (gusset)
4. C4 (2) lc, (gusset)
5. C5 (4) lc, (retainer block reinforcement)
6. C6 (4) lc, (retainer block)

WOOD STOCK

- (2) 1/4" x 1/4" x 36" spruce, (canopy rail)
- (1) 1/4" x 1/4" x 12" spruce, (canopy cross brace)
- (2) 3/32" x 3" x 36" (canopy floor sheeting)

MISC.

1. canopy, clear plastic
-

COWL

1. Cowl ring (1) lc, (aft end former)
2. CW1 (8) lc, (cowl retainer block)
3. CW2 (4) lc, (cowl mounting block)
4. CW3 (1) lc, (cowl former)
5. CW4 (2) lc, (cowl side stiffner)
6. CW5 (1) lc, (nose ring)

MISC.

1. upper and lower cowl halves, ABS plastic
-

WHEEL PANT

1. WP1 (2) lc, (wheel pant reinforcement)
2. WP2 (2) lc, (wheel axle support)

MISC.

1. (2) pair wheel pant, ABS plastic.

2. (1) Aluminum landing gear

NOTES:

SUGGESTED HARDWARE LIST

GENERAL

1. 6 channel radio
2. engine – 3.7 to 5.0 cu/in.
3. Muffler – Indy # EXR07445 (Zenoah 445)
4. Fuel tank – 24 to 32 oz, Sullivan
5. Propeller – suitable size to fit engine
6. Fuel line
7. 4-1/2" spinner – TruTurn # TT-4052-B
8. covering, paint and trim – your choice
9. 4" wheels – DuBro # 400TL or Sullivan

FUSELAGE

1. prop extension – Robart Mfg.
2. 1/4-20 x 1" soc. hd. cap screw (7) (eng mount/landing gear)
3. 1/4" flat washer (7) (eng. mount/landing gear)
4. 1/4" lock washer (7) (eng. mount/landing gear)
5. 6-32 x 5/8" soc. Hd. cap screw (12) (cowl, canopy and hatch)
6. # 6 flat washer (14) (cowl canopy, hatch, pants)
7. # 6 lock washer (14) (cowl, canopy, hatch, pants)
8. #6 All Threads insert (6) (Ohio Superstar) cowl/wheel pants)
9. 3/16" axle (2) (DuBro #249) (landing gear)
10. 3/16" wheel collar (4) (DuBro #141) (landing gear)
11. # 6 blind nut (8) (canopy and hatch)
12. solder link,4-40 (4) (DuBro #305) (rudder/elevator)
13. Kwik-link with rod (4) (DuBro #306) (rudder and elevator control)
14. # 4 hex nut (4) (rudder and elevator control)
15. aileron connector (1) (DuBro # 103) (tailwheel cont)
16. solder link 2-56 (1) (DuBro # 109) (tailwheel cont)
17. threaded rod (1) (DuBro # 172) (tailwheel cont)
18. kwik-link (1) (DuBro # 304) (tailwheel cont)
19. # 2 hex nut (1) (tailwheel control)
20. tailwheel (L) (1) (Ohio superstar Inc.)

WING

1. kwik-link, 4-40 (2) (DuBro # 305) (aileron pushrod)
2. threaded rod (2) (DuBro # 144) (aileron pushrod)
3. swivel link offset (2) (Rocket City Specialties # 69D) (aileron pushrod)
4. Robart Super Hinge (8) (aileron hinging)
5. # 6-32 x 1-1/4" soc. hd. cap. screw (2) (wing retainer)

TAIL

1. large scale T style control horn (4) (DuBro #366)
2. tail brace wire kit (2) (Sullivan # S-546) (tail)
3. Robart Super Hinge (8) (rudder and elevator hinging)

Staudacher S300

WARNING! THIS IS NOT A TOY!

**THIS IS NOT A BEGINNERS
AIRPLANE**

This R/C kit and the model you will build from it is not a toy! It is capable of serious bodily harm and property damage. It is your responsibility, and yours alone - to build this kit correctly, properly install all R/C. components and flying gear (engine, tank, radio, pushrods, etc. and to test the model and fly it only with experienced, competent help, using common sense and in accordance with all safety standards as set forth in the Academy of Model Aeronautics Safety Code. It is suggested that you join the AMA and become properly insured before attempting to fly this model. If you are just starting R/C modeling, consult your local hobby dealer or write to the Academy of Model Aeronautics to find an experienced instructor in your area.

Write to : Academy of Model Aeronautics,
5151 Memorial Dr, Muncie, IN 47302

LIMITED WARRANTY

Lanier R/C is proud of the care and attention that goes into the manufacture of parts for its model kits. The company warrants that for a period of 30 days, it will replace, at the buyers request, any parts or material shown to the company's satisfaction to have been defective in workmanship or material at the time of purchase.

No other warranty of any kind, expressed or implied, is made with respect to the merchandise sold by the company. The buyer acknowledges and understands that he is purchasing only a component kit from which the buyer will himself construct a finished flying model airplane. The company is neither the manufacturer of such a flying model airplane, nor a seller of it. The buyer hereby assumes the risk and all liability for personal or property damage or injury arising out of the buyers use of the components or the finished flying model airplane, whenever any such damage or injury shall occur.

Any action brought forth against the company, based on the breach of the contract of sale to the buyer, or on any alleged warranty thereunder, must be brought within one year of the date of such sale, or there after be barred. This one year limitation is imposed by agreement of the parties as permitted by the laws of the state of Georgia.