

Heli-Max®

VOLTAGE

500 - 3D

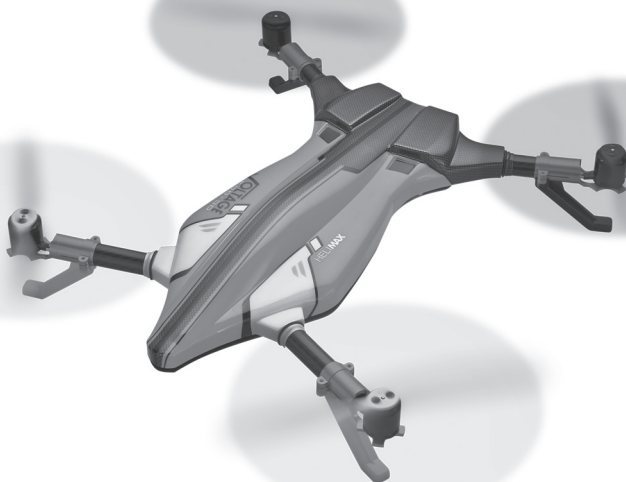

INSTRUCTION MANUAL

WARNING

Please fully read and understand this manual and the operation and all safety aspects required of you for the safe operation of this product. Before use, if you feel this product is not for you please return it to your place of purchase.

Heli-Max products are to be used by ages 14 and over.

Manual Specifications and Description Changes

The instruction manual, warranties and other associated documentation are subject to change without notice. Hobbico assumes no responsibility for inadvertent errors to this manual.

INTRODUCTION

Thank you for purchasing the Helimax® Voltage 500 3D. We want the time you spend with your new R/C quadcopter to be fun and successful, so please read the entire manual before beginning setup. If for any reason you think this R/C model is not for you, return it to the dealer immediately. Your dealer cannot accept returns on any model after final assembly.

FEATURES

- First 500-class reversing motor quad
- High visibility, easy orientation canopy
- Stability mode for safe 3D learning
- Long flight times are possible with 4S, 4,000 mAh batteries
- Efficient 8.9" 3D props provide the lift for incredible aerobatics
- Hybrid Carbon Fiber, G10, and machined aluminum frame
- Compatible with a wide range of 3 and 4S LiPo batteries
- Flight controller compatible with Futaba S.Bus, Standard PWM when used with S.Bus Encoder, JR XBUS, DSM2, DSMX and DSMJ radios
- 25 A reversing brushless speed controls
- 1400 kV brushless motors

CONTENTS

- Rx-R Voltage 500 3D
- Spare Props
- Hook & Loop Strip for the Battery

DIMENSIONS

Size: 500 mm (19.7 in) diagonally

Width: 380 mm (14.9 in)

Blade Length: 226 mm (8.9 in)

Weight: 907 g (32 oz) without battery

FLIGHT MODES

The Voltage 3D has two flight modes.

3D Mode – 3D Mode has no limits on the tilt angle and the quadcopter will not level itself in this mode.

Stability Mode – The Stability Mode will limit the quad to a maximum tilt angle of 45 degrees. When the stick is centered, the flight controller will level the quad. This mode makes the Voltage 3D easy to use by pilots that are just learning 3D. Experienced pilots would assign this mode to a momentary switch so the quad can be leveled quickly if they encounter a problem while practicing a 3D maneuver.

SETUP

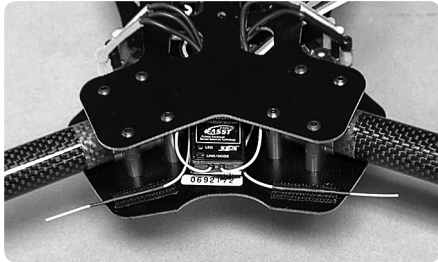
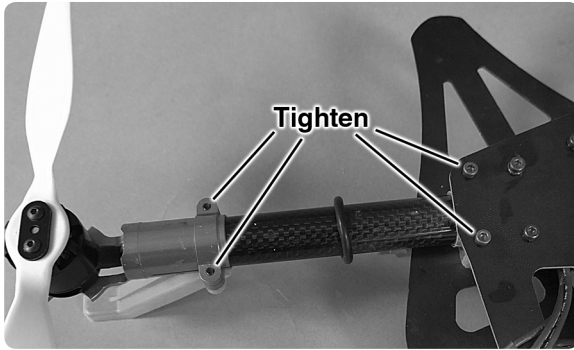

The Voltage 500 3D does not need any assembly. All the non-adjustable bolts have been set to the proper torque and have thread locking compound applied to keep them secure. The tension of bolts that clamp the booms should be checked before each flight by twisting each motor mount. If the boom is not tight, these bolts should be tightened.

Your transmitter should have at least 5 channels with a 3 position switch for channel 5. Channel 5 is used to disarm the motors and select the 3D or stability flight modes. The setup below is typical for most Futaba and Tactic transmitters.

Most Spektrum radios can use a similar setup by using the channel name and not reversing the throttle channel. A small receiver can be mounted on the top plate and still fit below the canopy. We recommend mounting the receiver at the back of the frame between the rear tube holders.

MODEL TYPE: Airplane

CHANNEL ASSIGNMENTS				
Channel	Direction	End Points	Dual Rates	Expo
Aileron	normal	100/100	80/100	-30/0
Elevator	normal	100/100	80/100	-30/0
Throttle	reverse	100/100		
Rudder	normal	100/100	80/100	-30/0
Gear	normal	100/100		

SWITCH ASSIGNMENTS - Ch 5		
Gear	-100%	Motors Disarmed
Gear	0%	3D mode
Gear	+100%	Attitude mode

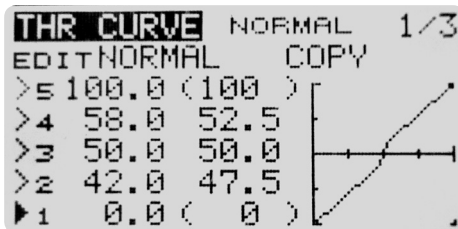

Make sure that your throttle curve is linear. The motor's transition time from forward to reverse can be reduced by setting points a few % above and below midstick, making the throttle curve as steep as possible between those points.

Before testing your setup, remove the props from the motors. Turn on the transmitter and connect the battery to the Voltage 500 3D. Use the LED codes on the Flight Controller to verify that Gear switch can select the Motor Disarm mode and the two flight modes.

Next, arm the motors by selecting one of the flight modes and advance the throttle so it is at or just above midstick. When the motors start to spin, hold the throttle until the motors speed up and slow down to idle. Now advance the throttle to speed up the motors and move the right stick in any direction. The motors on the opposite side of the quad will speed up so they can tilt the quadcopter in the desired direction. When you have made sure that the quad is responding to the controls correctly, move the Gear switch back to the Disarm position to stop the motors.

NOTE: If your transmitter has a Throttle Hold Gyro setting in the heli mode, setting the gyro to -100% on channel 5 will allow the throttle hold switch to disarm the motors. Setting the Idle-up and normal mode gyros to 0 and $+100\%$ on channel 5 will allow the idle-up switch to be used to select the 3D or Stability flight modes. Using the separate switch to arm and disarm the motors eliminates the possibility of shutting off the motors while changing flight modes.

FLIGHT CONTROLLER

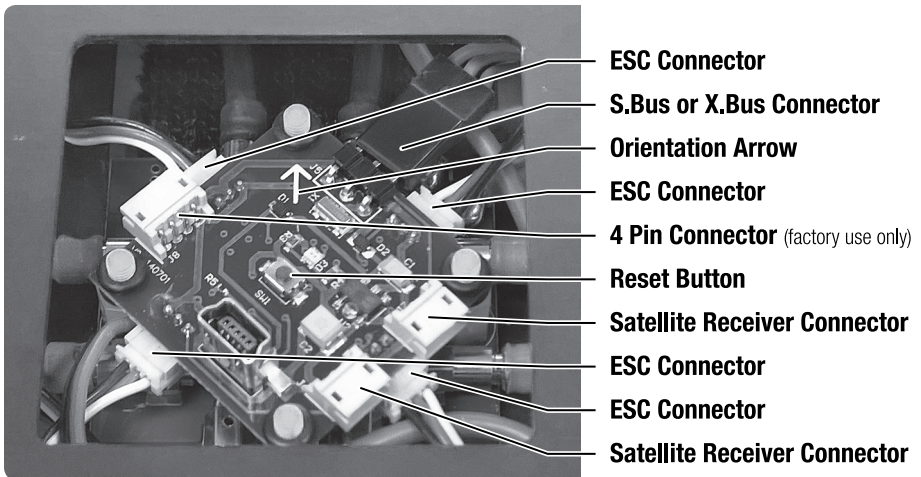

The Flight Controller (FC) has an orientation arrow that must point towards the front of the Voltage 500 3D.

ESC Connectors

There are 4 connectors for the speed controls located on the lower side of the FC.

Reset Button

The button in the center of the FC should be pressed to reset the FC if it locks up while uploading new firmware.

FLIGHT CONTROLLER LED CODES	
Color	Indicator
Red	Controller not receiving TX signal
Steady Green	Motors Disabled
Rapid Flashing Green	3D mode
Slow Flashing Green	Attitude mode

VOLTAGE 3D APP

The Voltage 500 3D has an app that can also be used to verify that the controls and switches are setup correctly. This app must be used to change the gyro settings in the flight controller. A mini USB cable (not included) will be needed to connect the Voltage 500 3D flight controller to your PC.

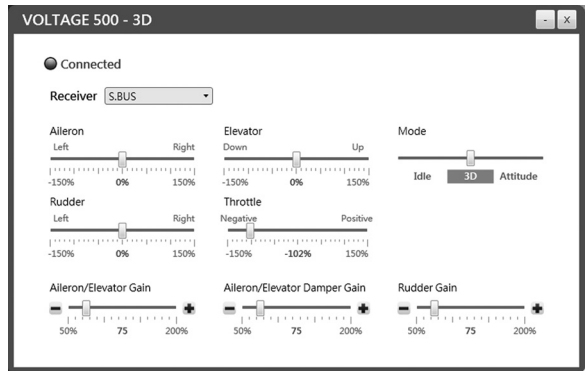

The latest version of the Voltage 3D app, the manual and the Windows USB driver can be found at www.helimax-rc.com

Download and unzip the driver files. Click on the Installer application to install the drivers on your computer.

Download the latest version of the Voltage 3D app and install it on your PC.

WARNING: Before using the app, remove the propellers from the motors. The motors can be armed and operated while the flight controller is connected to the Voltage 3D app.

Turn on the transmitter and connect a flight battery to the Voltage 500 3D. When you see a steady green LED, connect the USB cable to your computer and the USB port on the flight controller.

To test the setup, move each control stick in both directions to verify that the controller is receiving the signal on the proper channel and is moving in the correct direction. Also make sure that the switches for the motor disarm and flight modes are responding properly.

	FACTORY DEFAULT GYRO SETTINGS
Aileron/Elevator Gain	70
Aileron/Elevator Damping	65
Rudder Gain	70

These settings were tested with 3S and 4S batteries.

TIP: While removing the USB cable from the flight controller, push down on the controller to keep it from moving. If any of the o-rings on the mounting posts are lost, the controller may come loose in flight.

FAILSAFE

If your transmitter can set values for all the channels for failsafe, set channels 1-4 to a midstick value and set channel 5 to – 100% which will stop the motors. For transmitters that only set the failsafe on the throttle channel, set the throttle to 50%. (midstick)

Be sure to remove the props before testing the failsafe operation.

BATTERIES

The Voltage 3D can use a 3 cell or 4 cell LiPo between 2200mAh and 4000mAh. The flight time can be as long as 12 minutes with a large battery and a very mild flying style. The flight controller does not have a low voltage cutoff to protect the LiPo from damage. The LEDs on the bottom of the speed controls will start flashing when the battery is at 10.2V for a 3S battery and 13.6V for a 4S LiPo. For your first flight, set a timer for 3 minutes. If the LEDs are not flashing at the end of the flight, increase your flight time a few seconds. If the LEDs on the speed controls are flashing at the end of the flight, the timer setting should be reduced by at least 10 seconds to protect the battery.



WARNING: Your battery life will be shortened and the battery can be damaged any time the voltage drops below 3.25 V/cell. Charging a LiPo battery that is damaged in any way can pose a fire hazard.

We recommend using a voltage monitor/alarm that plugs into the battery's balance connector and will sound an alarm when the battery voltage gets low.

PROP INSTALLATION

There are 2 "A" props, one of each color. These props spin CCW.

There are 2 "B" props, one of each color. These props spin CW.

A little thread locking compound should be used on the screws that hold the props on the motor.

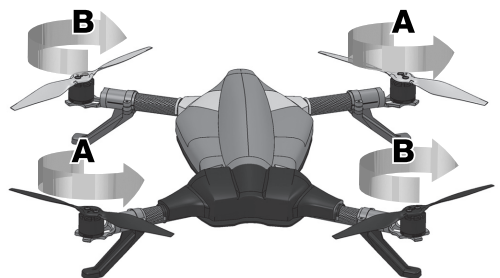

MOTOR ARMING

Set the transmitter so the motors are disarmed.

Place the Voltage 3D on a level surface and connect the battery. If the quad is not level when powered up, it may drift when the sticks are centered.

After the speed controls have chimed twice, pause, and then chime again, select the desired flight mode and arm the motors if the transmitter is using throttle hold.

Advance the throttle to just above midstick and wait for the motors to start spinning. When they speed up and slow down to idle, the Voltage 3D is ready to fly.

WARNING: If your transmitter is set up to use the same switch for disarming the motors and selecting the flight mode, be careful when switching from Stability Mode to 3D Mode while in flight. If the switch is moved to the motor disable position, the motors will stop.

TROUBLESHOOTING

Motors will not arm

Make sure that the throttle trim is centered and the throttle is at or just above midstick.

Check the throttle curve for offset. The throttle should be at 0 when the stick is centered.

Motors spin but the quadcopter will not take off

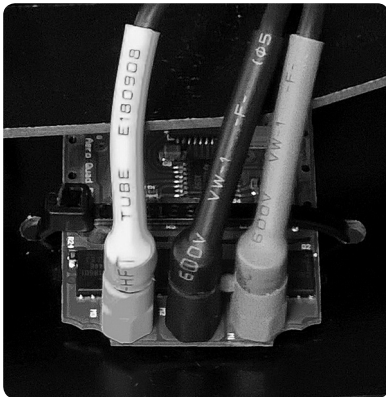

On the front left and rear right ESC, the colors on two of the wires will not match the sockets.

If parts have been replaced, check the motor wires on each ESC. The color of the wire should match the colors on the socket for the front right and rear left ESC.

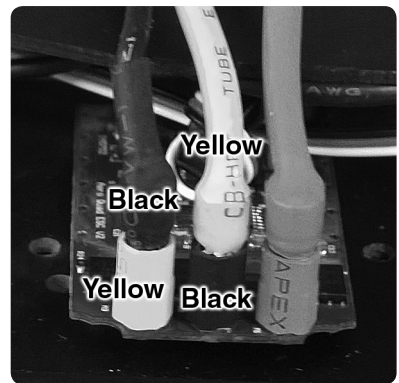

Make sure that the props are installed correctly and the motors are spinning in the correct direction. Please refer to the diagram in the Prop Install section.

SPARE PARTS

- 1 HMXE2402 Lower Frame
- 2 HMXE2401 Upper Frame
- 3 HMXE2403 CF Booms (4)
- 4 HMXG2405 Brushless Motor
- 5 HMXE2407 8.9" 3D Prop Set (4)
- 6 HMXM2410 Voltage 500 3D Flight Controller Set
- 7 HMXE2412 CNC Tube Holder 19 mm
- 8 HMXE2413 Voltage 500 3D Red Body
- 17 HMXE2422 Voltage 500 3D Clear Body
- 9 HMXE2416 Landing Gear Red
- 10 HMXE2417 Landing Gear Black
- 11 HMXE2418 Motor Mount
- 12 HMXM2414 Voltage 500 3D ESC
- 13 HMXE2419 Screw Set
- 14 HMXE2415 O-ring Set
- 15 HMXE2420 Prop Bolts
- 16 HMXE2421 Velcro Battery Strap
- HMXE2411 Sbus Encoder Cable

EXPLODED VIEW

