

Heli-Max™



INSTRUCTION MANUAL



Rotor Span: 20.75 in [528mm]

Height: 8.125 in [206mm]

Length: 23 in [584mm]

Weight: 16.5 oz [468g]

Radio: 5-Channel FM with 3 micro servos and Receiver with built-in ESCs and Gyro

Motor: 380 Brushed motor

WARRANTY

Heli-Max™ guarantees this kit to be free from defects in both material and workmanship at the date of purchase. This warranty does not cover any component parts damaged by use or modification. **In no case shall Heli-Max's liability exceed the original cost of the purchased kit.** Further, Heli-Max reserves the right to change or modify this warranty without notice.

In that Heli-Max has no control over the final assembly or material used for final assembly, no liability shall be assumed nor accepted for any damage resulting from the use by the user of the final user-assembled product. By the act of using the user-assembled product, the user accepts all resulting liability.

If the buyer is not prepared to accept the liability associated with the use of this product, the buyer is advised to return this kit immediately in new and unused condition to the place of purchase.

To make a warranty claim, send the defective part or item to Hobby Services at this address.

**Hobby Services
3002 N. Apollo Dr., Suite 1
Champaign, IL 61822
USA**

Include a letter stating your name, return shipping address, as much contact information as possible (daytime telephone number, fax number, e-mail address), a detailed description of the problem and a photocopy of the purchase receipt. Upon receipt of the package the problem will be evaluated as quickly as possible.

READ THROUGH THIS INSTRUCTION MANUAL FIRST. IT CONTAINS IMPORTANT INSTRUCTIONS AND WARNINGS CONCERNING THE ASSEMBLY AND USE OF THIS MODEL.

Heli-Max™

Champaign, Illinois
(217) 398-8970

E-mail: helihotline@hobbico.com

TABLE OF CONTENTS

INTRODUCTION	2
AMA	2
SAFETY PRECAUTIONS	2
ADDITIONAL ITEMS REQUIRED	3
ORDERING REPLACEMENT PARTS	3
KIT INSPECTION	4
KIT CONTENTS	4
METRIC/INCH RULER	4
ASSEMBLY INSTRUCTIONS	5
GET THE MODEL READY TO FLY	6
PREFLIGHT	7
AMA SAFETY CODE (excerpts)	7
CONTROLS	8
FLYING	9
MAINTENANCE	11
OPTIONAL UPGRADE	13
PARTS LIST / OPTIONAL PARTS	16
DETAILED VIEW OF ROTOR HEAD / EXPLODED VIEW	17
PARTS IMAGES	18
OPTIONAL PARTS IMAGES	Back Cover Page

INTRODUCTION

Thank you for purchasing the Heli-Max AXE™ Mini EP RTF Helicopter. We are certain you will get many hours of enjoyment out of this model. If you should have any questions or concerns please feel free to contact us at helihotline@hobbico.com.

For the latest technical updates or manual corrections to the AXE Mini EP RTF visit the Heli-Max web site at www.helimax-rc.com. Open the "Helicopters" link, and then select the AXE Mini EP RTF. If there is new technical information or changes to this model a "tech notice" box will appear in the upper left corner of the page.

CAUTION: Be aware that the AXE Mini EP RTF operates on the same frequency band as larger R/C models. If flying your AXE Mini EP RTF within five miles of an R/C site, there is a real possibility that you could be operating your model on the same frequency (channel) as another R/C pilot. If this happens, a crash will result—with the person flying the more expensive model suffering the greater loss (and having greater potential for property damage or injury). The best thing to do is to join an R/C club and fly at the site where frequency control measures will be in effect. If you insist on flying elsewhere, **always be aware of your proximity to R/C flying sites.**

AMA

We urge you to join the AMA (Academy of Model Aeronautics) and a local R/C club. The AMA is the governing body of model aviation and membership is required to fly at AMA clubs. Though joining the AMA provides many benefits, one of the primary reasons to join is liability protection. Coverage is not limited to flying at contests or on the club field. It even applies to flying at public demonstrations and air shows. Failure to comply with the Safety Code (excerpts printed in the back of the manual) may endanger insurance coverage. Additionally, training programs and instructors are available at AMA club sites to help you get started the right way. There are over 2,500 AMA chartered clubs across the country. Contact the AMA at the address or toll-free phone number below.



Academy of Model Aeronautics
5151 East Memorial Drive
Muncie, IN 47302
Tele: (800) 435-9262
Fax (765) 741-0057
Or via the Internet at:
<http://www.modelaircraft.org>

IMPORTANT!!! Two of the most important things you can do to preserve the radio controlled model hobby are to avoid flying near full-scale aircraft and avoid flying near or over groups of people.

SAFETY PRECAUTIONS

Failure to follow these safety precautions may result in severe injury to yourself and others.

Keep your face and body as well as all spectators away from the plane of rotation of the rotors whenever the battery is connected.

Keep these items away from the rotors: loose clothing, shirt sleeves, ties, scarfs, long hair or loose objects such as pencils or screwdrivers that may fall out of shirt or jacket pockets into the rotors.

The spinning blades of a model helicopter can cause serious injury. When choosing a flying site for your AXE Mini EP RTF, stay clear of buildings, trees and power lines. AVOID flying in or near crowded areas. DO NOT fly close to people, children or pets. Maintain a safe pilot-to-helicopter distance while flying.

1. Your AXE Mini EP RTF should not be considered a toy, but rather a sophisticated, working model that functions very much like a full-size helicopter. Because of its performance capabilities, the AXE Mini EP RTF, if not assembled and operated correctly, could possibly cause injury to yourself or spectators and damage to property.

2. You must assemble the model **according to the instructions**. Do not alter or modify the model, as doing so may result in an unsafe or un-flyable model. In a few cases the instructions may differ slightly from the photos. In those instances the written instructions should be considered as correct.

3. You must correctly install all R/C and other components so that the model operates correctly on the ground and in the air.

4. You must check the operation of the model before **every** flight to insure that all equipment is operating and that the model has remained structurally sound. Be sure to check linkages or other connectors often and replace them if they show any signs of wear or fatigue.

5. If you are not an experienced pilot or have not flown this type of model before, we recommend that you get the assistance of an experienced pilot in your R/C club for your first flights. If you're not a member of a club, your local hobby shop has information about clubs in your area whose membership includes experienced pilots.

We, as the manufacturer, provide you with a top quality, thoroughly tested helicopter and instructions, but ultimately the quality and flyability of your finished model depends on how you build it; therefore, we cannot in any way guarantee the performance of your completed model, and no representations are expressed or implied as to the performance or safety of your completed model.

Remember: Take your time and follow the instructions to build a safe and enjoyable model.

ADDITIONAL ITEMS REQUIRED

- Great Planes® Pro™ Foam Safe CA+ Medium Glue
1 oz. (GPMR6069)
- Eight "AA" Alkaline Batteries for the Transmitter

ORDERING REPLACEMENT PARTS

Replacement parts for the Heli-Max AXE Mini EP RTF are available using the order numbers in the **Parts List** on page 12. The fastest, most economical service can be provided by your hobby dealer.

To locate a hobby dealer, visit the Hobbico web site at **www.hobbico.com**. Choose "Where to Buy" at the bottom of the menu on the left side of the page. Follow the instructions provided on the page to locate a U.S., Canadian or International dealer.

Parts may also be ordered directly from Hobby Services by calling (217) 398-0007, or via facsimile at (217) 398-7721, but full retail prices and shipping and handling charges will apply. Illinois and Nevada residents will also be charged sales tax. If ordering via fax, include a Visa® or MasterCard® number and expiration date for payment.

Mail parts orders and payments by personal check to:

Hobby Services
3002 N. Apollo Drive, Suite 1
Champaign, IL 61822

Be certain to specify the order number exactly as listed in the **Parts List**. Payment by credit card or personal check only; no C.O.D.

If additional assistance is required for any reason contact Product Support by e-mail at **helihotline@hobbico.com**, or by telephone at (217) 398-8970.

KIT INSPECTION

Before starting assembly, take an inventory of the AXE Mini EP RTF to make sure it is complete, and inspect the parts to make sure they are of acceptable quality. If any parts are missing or are not of acceptable quality, or if you need assistance with assembly, contact **Product Support**. When reporting defective or missing parts, use the part names exactly as they are written in the Kit Contents list.

Heli-Max Product Support:
3002 N. Apollo Drive, Suite 1
Champaign, IL 61822
Telephone: (217) 398-8970, ext. 5
Fax: (217) 398-7721
E-mail: helihotline@hobbico.com

KIT CONTENTS

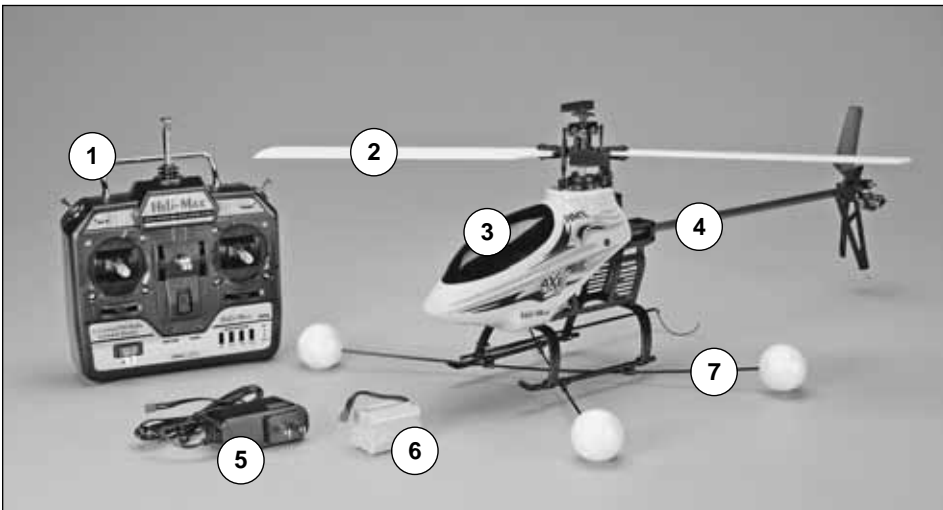

Kit Contents

1. Transmitter
2. Main Rotor Blades (2)
3. Body
4. Helicopter
5. 110V Wall Charger
6. 10.8v NiMH Battery
7. Training Gear (Carbon Rods, Fittings, Foam Balls)

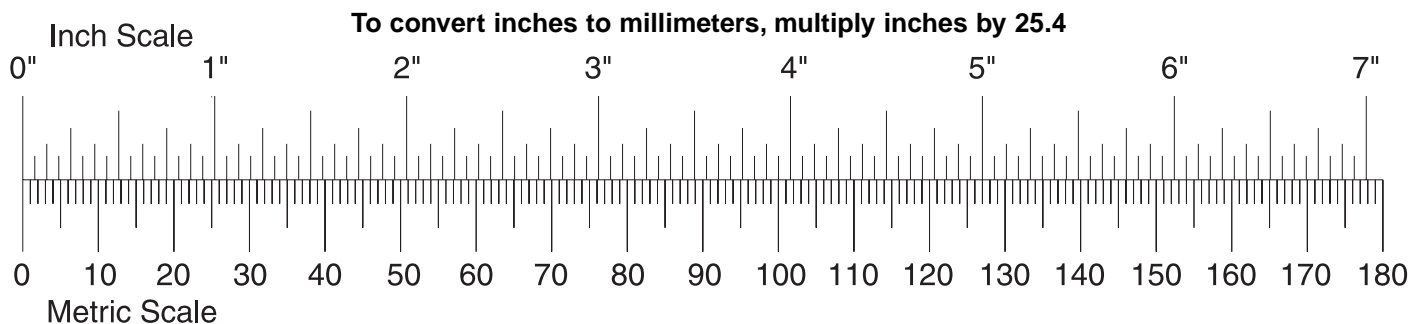

ASSEMBLY INSTRUCTIONS

Install Batteries in the Transmitter



❑ Remove the battery cover from the back of the transmitter. Remove the battery box and install eight "AA" batteries in the transmitter. Double-check the polarity of each battery before replacing the battery cover.

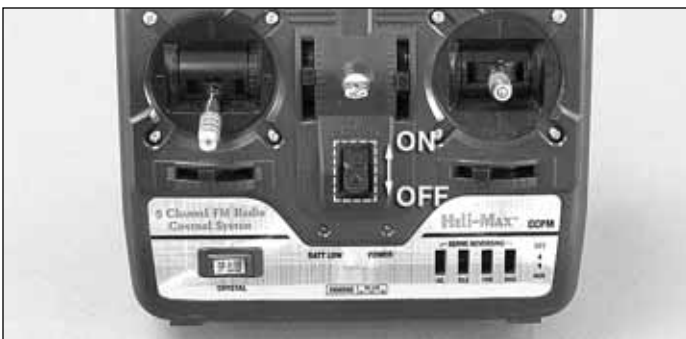

❑ Turn on the transmitter using the power switch as shown above. Check the LEDs on the front of the transmitter. Only the Green LED should be on. If the Red LED is on, then the batteries need replacing.

Install the Transmitter Antenna



❑ Insert the antenna into the top of the transmitter and turn clockwise until tight.

Charging the Flight Battery

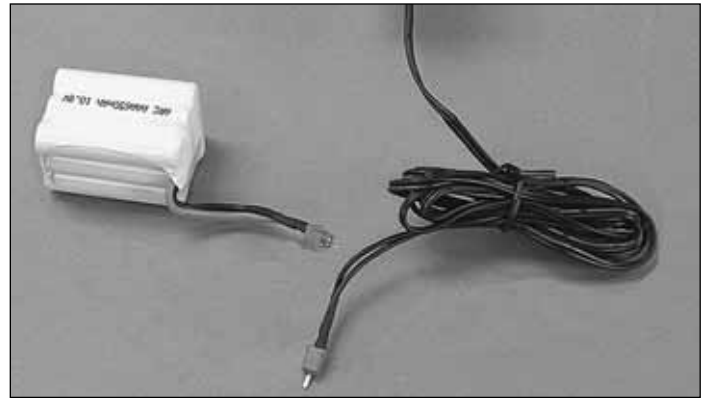

❑ **WARNING!** The charger supplied with the AXE Mini EP RTF is only meant to charge the supplied NiMH battery pack. Do not attempt to charge any other type of battery with this charger.



❑ Plug the battery charger into an AC outlet. The light on the charger should be Green. Now plug the battery pack into the charger. The light should turn Red, which indicates charging. Once the battery is completely charged the light will turn Green again, indicating it is done.

If your flight battery is completely discharged it will take approximately one hour to re-charge.



❑ The optional ElectriFly™ 11.1V 910mAh 15C balance BP910 Lithium-Polymer battery (GPMP0709) can be used for longer flight times and increased power. You must purchase a special charger for Lithium-Polymer batteries such as the Great Planes Lithium-Polymer Charger (GPMM3110). To use this battery you will need to purchase a Deans Ultra to Micro Deans adapter (GPMM3127).

Install the Battery

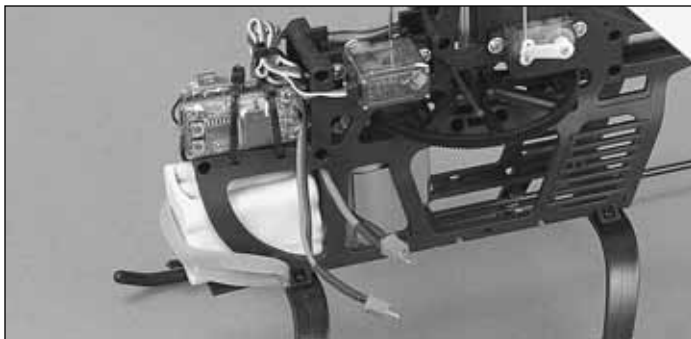

❑ Remove the canopy by sliding the canopy grommets off of the carbon rods. Slide the battery into the front of the battery tray as shown above. Use a rubber band to hold the battery into the tray.

Install Main Rotor Blades

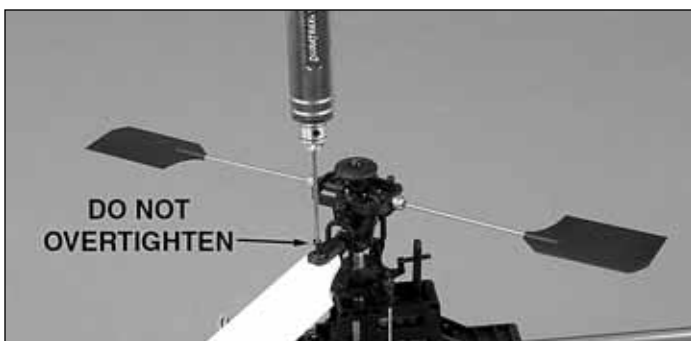

❑ Using the 2 x 12mm hex bolts, mount the main rotor blades as shown. Be careful not to overtighten them.

Blade Tension Test



❑ To test the blade tension, hold the helicopter up sideways. The blades should support themselves until the helicopter is shaken slightly; then they will fall as shown in the picture above. The blades should be fairly loose but it is critical that both blades be the same tension.

Assemble Training Gear

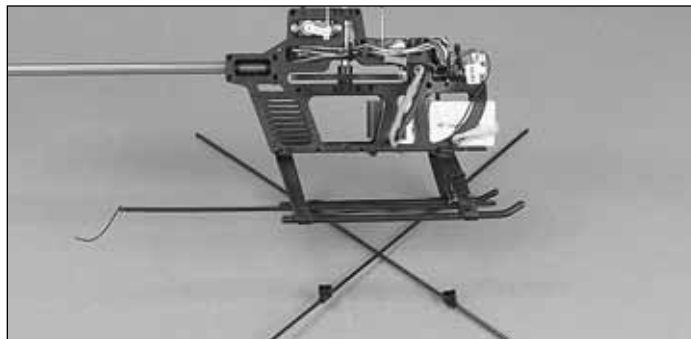

❑ Snap the four plastic fittings onto the landing gear as shown. Slide the carbon rods through the underside of the fittings. Center the carbon rods and apply a drop of medium CA to the fittings to lock the carbon rods in place. Also apply a drop of CA to the landing gear skids where the fittings snap on.



❑ Cut the supplied silicone tubing into eight 1/8" [3mm] pieces. Please keep in mind that carbon rods are dangerous to handle and splinter easily. Using pliers carefully slide the silicone tubing onto the carbon rod approximately 4" [102mm]. Now install a foam ball followed by a washer. Now using pliers install the last piece of fuel tubing. Repeat this step for the other three balls.



Electric Motor Warning

Electric motors are very dangerous. Please remove the pinion gear or unplug the motor while working on the model. If your heli uses an electric tail motor, make sure it is unplugged as well.



Turning the Model On

Always turn the Transmitter on first and ensure the idle up switch is off. With the AXE Mini EP RTF sitting still, plug the battery into the ESC. The AXE Mini EP RTF must sit still for 10 seconds so the gyro can initialize and determine center. If the AXE Mini EP RTF is moved during this initialization, then the gyro will not operate properly.

Always step 15 feet away from the AXE Mini EP RTF before flipping any switches or operating the throttle. Do not hold onto the model and run it up. Safety first.

Range Check

Ground check the operational range of your radio before the first flight of the day. For safety reasons, unplug the main motor so power cannot be applied to the main rotor blades. With the transmitter antenna collapsed and the receiver and transmitter on, you should be able to walk at least 50 feet away from the model and still have control. Have an assistant stand by your model and while you work the controls, tell you what the servos are doing. If the controls do not respond correctly, **do not fly!** Find and correct the problem first. Look for loose servo connections or broken wires, corroded wires on old servo connectors, poor solder joints in your battery pack or a defective cell or a damaged receiver crystal from a previous crash.

Balance the Main Blades

The AXE Mini EP RTF main rotor blades are already balanced and ready to fly.



Identify Your Model

No matter if you fly at an AMA sanctioned R/C club site or if you fly somewhere on your own, you should always have your name, address, telephone number and AMA number on or inside your model. It is **required** at all AMA R/C club flying sites and AMA sanctioned flying events. Fill out the identification tag on page 11 and place it on or inside your model.



Read and abide by the following excerpts from the Academy of Model Aeronautics Safety Code. For the complete Safety Code refer to *Model Aviation* magazine, the AMA web site or the Code that came with your AMA license.

General

1) I will not fly my model aircraft in sanctioned events, air shows, or model flying demonstrations until it has been proven to be airworthy by having been previously, successfully flight tested.

2) I will not fly my model aircraft higher than approximately 400 feet within 3 miles of an airport without notifying the airport operator. I will give right-of-way and avoid flying in the proximity of full-scale aircraft. Where necessary, an observer shall be utilized to supervise flying to avoid having models fly in the proximity of full-scale aircraft.

3) Where established, I will abide by the safety rules for the flying site I use, and I will not willfully and deliberately fly my models in a careless, reckless and/or dangerous manner.

5) I will not fly my model unless it is identified with my name and address or AMA number, on or in the model. **Note:** This does not apply to models while being flown indoors.

7) I will not operate models with pyrotechnics (any device that explodes, burns, or propels a projectile of any kind).

Radio Control

1) I will have completed a successful radio equipment ground check before the first flight of a new or repaired model.

2) I will not fly my model aircraft in the presence of spectators until I become a qualified flier, unless assisted by an experienced helper.

3) At all flying sites a straight or curved line(s) must be established in front of which all flying takes place with the other side for spectators. Only personnel involved with flying the aircraft are allowed at or in the front of the flight line. Intentional flying behind the flight line is prohibited.

4) I will operate my model using only radio control frequencies currently allowed by the Federal Communications Commission.

5) **I will not knowingly operate my model within three miles of any pre-existing flying site except in accordance with the frequency sharing agreement listed** (in the complete AMA Safety Code).

9) Under no circumstances may a pilot or other person touch a powered model in flight; **nor should any part of the model other than the landing gear, intentionally touch the ground, except while landing.**

CONTROLS

Always turn the Transmitter on first and ensure the idle up switch is off. With the AXE Mini EP RTF sitting still plug the battery into the ESC. The AXE Mini EP RTF will need to sit still for 10 seconds so the gyro can initialize and can determine center. If the AXE Mini EP RTF is moved during this initialization, then the gyro will not operate properly.

There is a safety built into the AXE Mini EP RTF that prevents the motor from activating unless the collective stick has been lowered to its lowest position. If the motor won't run and turn the main blades, please make sure the collective stick is all the way down and leave it there for two seconds.

Transmitter Controls

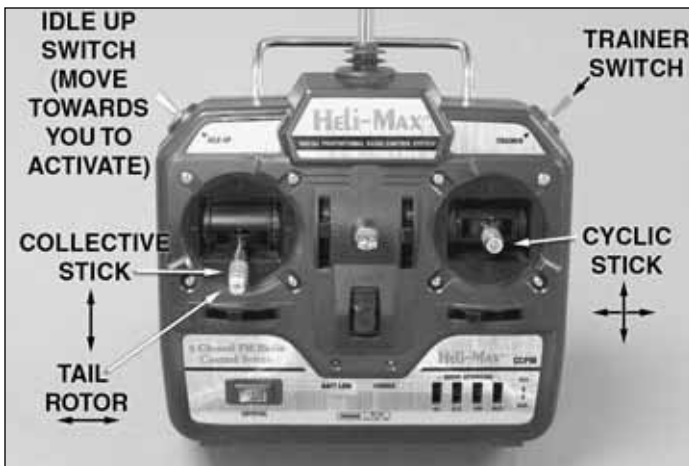

All controls are described with the tail pointing directly toward you. This is the best way to start out since it keeps the control inputs orientated the same direction. Once you become comfortable you can work on side in and nose in hovering.

Trainer System – You can use a cable to connect two transmitters together and an instructor can take and give control back with the release of a switch. Be careful not to hit this switch while in flight as it disables the transmitter output.

The idle up switch is used for forward flight and aerobatics. This switch raises the main rotor RPM and also changes the lowest position on the throttle stick to around 40% throttle. This allows the AXE Mini EP RTF to perform aerobatics and inverted flight. This can be a dangerous switch since it raises the throttle. **Be extremely careful not to hit this switch accidentally or the motor will instantly come on to at least 40% power.**

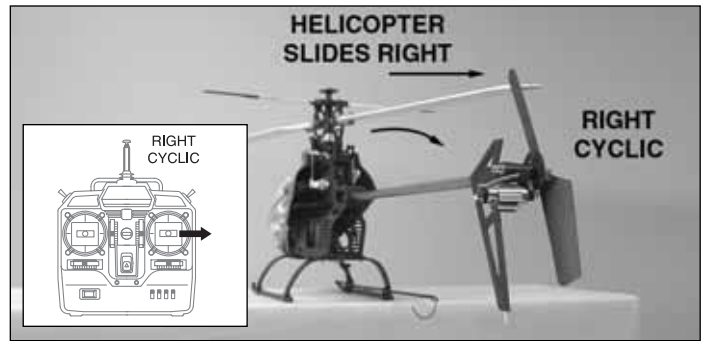

Moving the cyclic stick right will cause the helicopter to tilt right and start moving that direction.

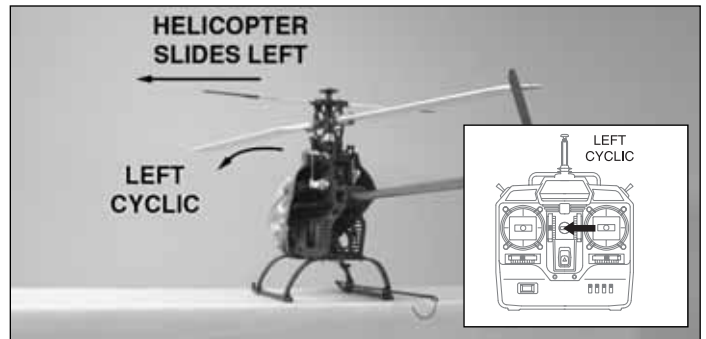

Moving the cyclic stick left will cause the helicopter to tilt left and start moving in that direction.

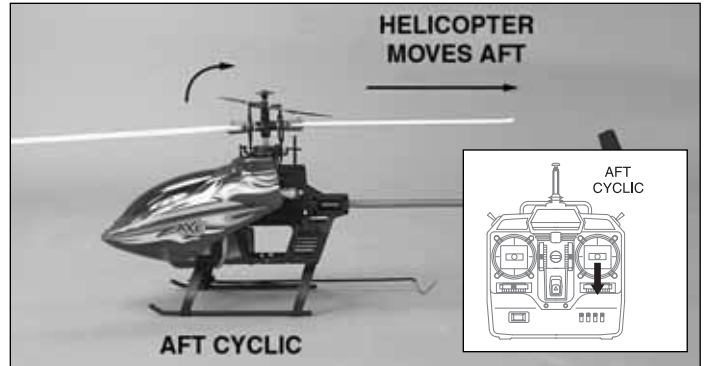

Moving the cyclic stick backwards (towards you) will cause the helicopter to tilt backwards and start moving that direction.

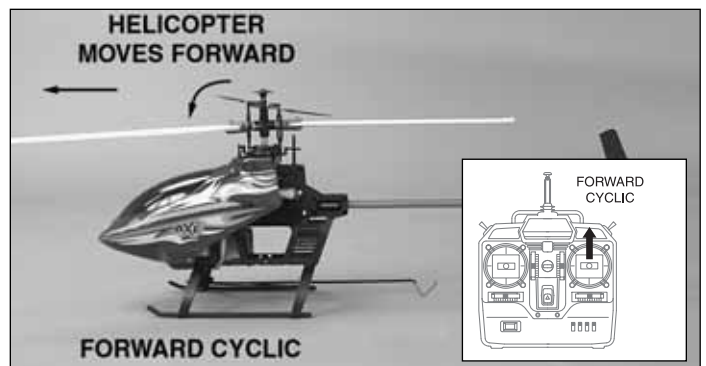

Moving the cyclic stick forward (away from you) will cause the helicopter to tilt forward and start moving that direction.



Moving the collective stick forward (away from you) will cause the helicopter to climb higher.



Moving the collective stick backwards (towards you) will cause the helicopter to descend.

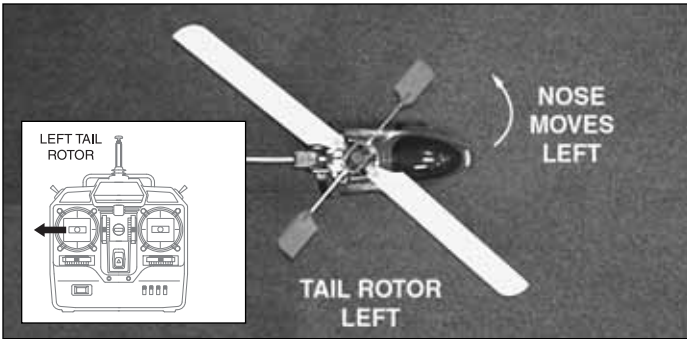

Moving the tail rotor stick left will cause the helicopter nose to move left (counterclockwise).

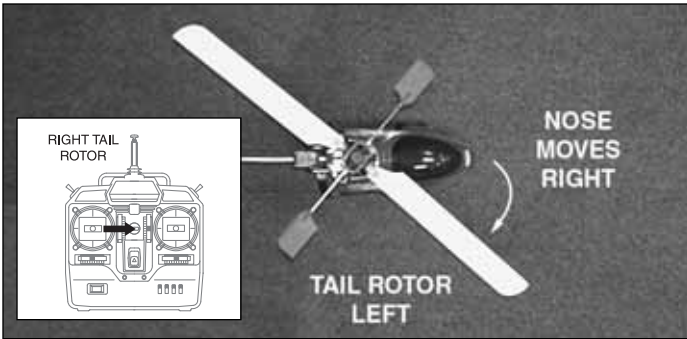

Moving the tail rotor stick right will cause the helicopter nose to move right (clockwise).

Tracking the Main Blades

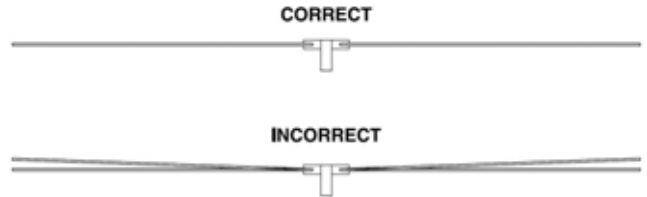
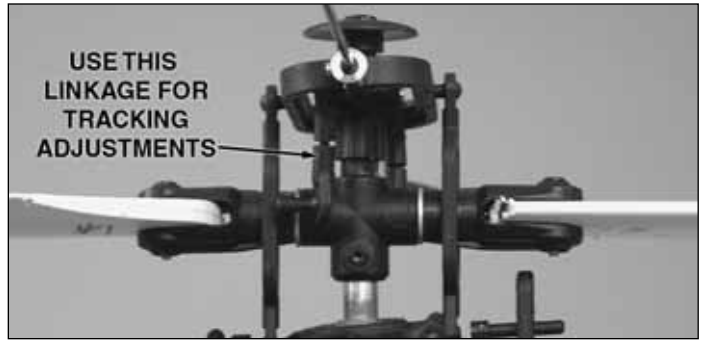

At zero pitch, bring the main rotor up to speed and observe whether the rotational planes of the blades are the same. If they are not, adjust one of the linkages to bring the blades into the same plane.

Apply the two different colored stripe decals to the tips of your main rotor blades.

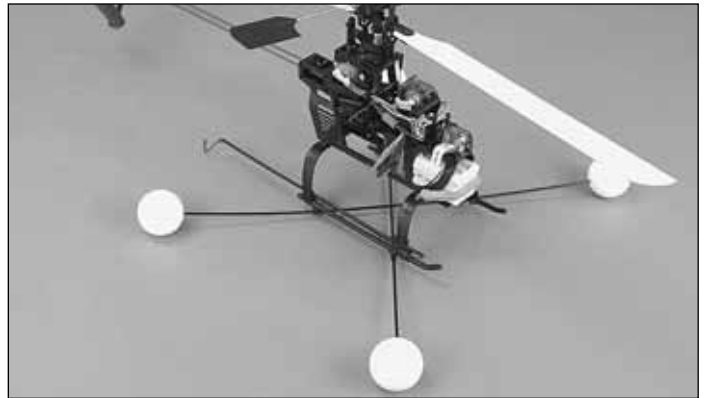

The training gear is a big help to beginners. They soften not so perfect landings and help to prevent the helicopter from tipping over. Even if you have experience flying a helicopter, please consider using the supplied training gear for the first few flights.



Takeoff

During your first flights it is important to have light winds and a helper to keep an eye on things around you. Also, if you are flying from grass, make sure it's cut low as this will allow the helicopter to slide around without catching. Also make sure there are no obstacles in your flying area to distract you.

Slowly add power and observe the model. If you feel it needs trimming, do so before lift off. You will quickly find that model helicopters never allow you to return the sticks to center. Simply hold the sticks as needed to keep a steady hover. Please don't fight the trim too much as it is a normal thing to experience, Winds have a large effect on model helicopters. Please wait for calmer days and slowly work into windy days.

You will notice the cyclic controls lag behind your inputs. This is perfectly normal and something you become accustomed to. It is normal to drift around some in a hover, until you get used to flying the model. The cyclic controls on the AXE Mini EP RTF are fairly sensitive so only small movements are necessary.

Hovering

Once the helicopter is in the air simply try to hold the helicopter in one spot. This will take some practice and wind has a big effect on the stability of the helicopter. Be patient and slowly progress, trying to rush the learning process can be costly.

Landing

Level the helicopter into a steady hover and slowly decrease power until the helicopter settles onto the ground.

Basic Maneuvers

Once you are comfortable with hovering at different orientations and landing, it's time to move on to more advanced maneuvers.

Slow Pirouettes – Add a small amount of tail rotor (left or right) and try rotating the helicopter slightly sideways and see if you can hold it there. If you become uncomfortable bring the tail back towards you. Once you are comfortable, try moving the helicopter to the side and turning back. Then fly back to the other side in straight lines.

You can try rotating the helicopter around 360 degrees, which is called a pirouette. The helicopter can drift during this maneuver so make certain you have plenty of room when you first start practicing.

After pirouettes it's time to move onto nose-in hovering. The best bet is to wait for a calm day. Take off and climb to 15 feet, practice half pirouettes from tail-in to nose-in hovering, and try to lengthen the delay between transitions. This will allow you to practice nose-in and still give you a chance to get out of trouble. As you improve you'll remain nose-in for longer periods of time.

Now it's time to work into basic forward flight. Just take the basic hovering maneuvers listed above and slowly fly out farther and faster and always bring the helicopter back after one pass. Practice controlled slow flight in close as well. The more time you spend practicing here the easier things will be later on.

Aerobatics

So you are getting comfortable in fast forward flight? Well, now it's time to slowly progress into aerobatics. Once you are in forward flight start using the idle up switch which raises the rotor RPM for aerobatics and allows the AXE Mini EP RTF to fly inverted. Also, in wind it may be difficult to descend to land without the idle up on.

Your first step is chandelles. Fly straight across in front of you and pull up to a 45° angle. Now at the top, when the helicopter slows down to a stop, apply some tail rotor to bring the nose around 180 degrees and continue back down the 45° angle.

As you progress with the maneuver you can pull a greater angle than 45 degrees, but 90 degrees would be considered a stall.

Loops – Once you become comfortable with the chandelles and stall turns it's time to move onto the loop. The key to the loop is to enter with plenty of speed. Start pulling aft cyclic to enter the loop and as the model transitions to inverted at the top of the loop pull back on the throttle (towards negative (-) collective) this will help maintain altitude. As the model returns back to vertical add some positive (+) collective to maintain the speed. One of the most common mistakes made on loops is using too much negative (-) collective at the top.

Flips – These are a lot easier than they sound. Be certain to start with plenty of altitude. From a upright hover slowly add in full forward cyclic and as the model approaches vertical bring the collective stick back to center. Now as the model continues to inverted you will need to start adding in negative (-) collective (or pull the collective stick back towards yourself). As the model transitions back to vertical again bring the collective stick back to the middle and start adding in positive (+) collective as the model comes back to upright.

It's simply a matter of timing. The most important thing is not to throw the sticks around as this can cause the head speed to drop and may cause the tail to drift.

Inverted Hovering – Keep in mind flying a helicopter inverted is very difficult but can be learned. One of the key problems is 3 out of 4 of the controls are reversed (forward/aft cyclic, collective and tail rotor). You have to mentally reverse these while flying. It will take some practice.

Take the loop you learned above and just hold the inverted portion for short periods of time. As you become accustomed to the reversed controls, you will extend the time inverted. It is very difficult and will take some practice. Also, make sure you have plenty of altitude for recovery if needed.

MAINTENANCE & REPAIR

E-Board Adjustments

Note: All of the e-board adjustments are pre-set and test flown at the factory. If you replace the e-board with a new one or need to re-adjust it for any reason, please follow the guidelines below. Never turn these adjustments more than 180° and only use a plastic non-conductive screwdriver to make the adjustment.

Tip: If you need to make some adjustments consider using a felt-tip marker and place a mark on the adjusters so you can always return them back to the factory defaults.

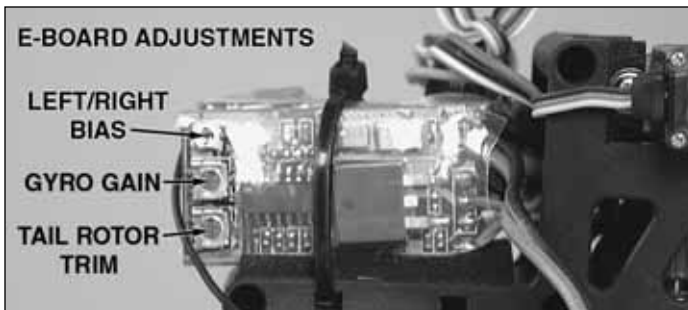

Left/Right Bias – Is used to obtain a balanced feel between left and right tail rotor inputs. The adjustment is very sensitive so only make small changes. Turn clockwise to increase the left tail rotor bias.

Gyro Gain – Turn clockwise to increase gain. Typically too little gyro gain causes the tail to slowly move around and drift. With the gyro gain too high, you will notice a very fast oscillation in the tail known as “Wag.” This adjustment is not very critical so please don’t spend a lot of time trying to get “the best” setting possible.

Tail Rotor Trim – If the helicopter wants to drift one direction in a stable hover then try using this adjustment. The adjustment is very sensitive so only make small changes. Turn clockwise to add right tail rotor trim.

Servo Setup

Note: The AXE Mini EP RTF is factory setup and test flown so there is no need to make these adjustments unless you have damaged or changed a servo.

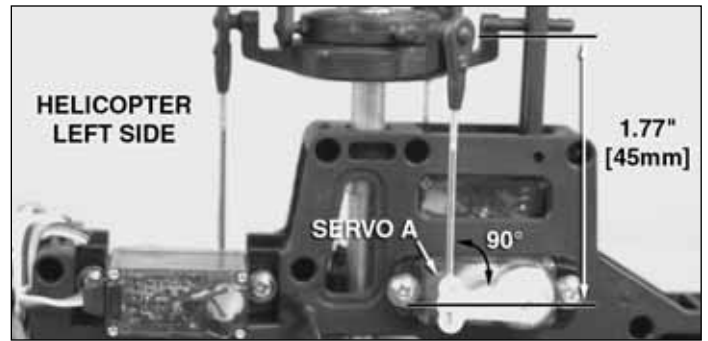

Servo arms are perfectly level when the throttle stick is all the way down in normal mode (Idle Up Off). Helicopter left side Servo A pushrod length should be 1.77" [45mm].

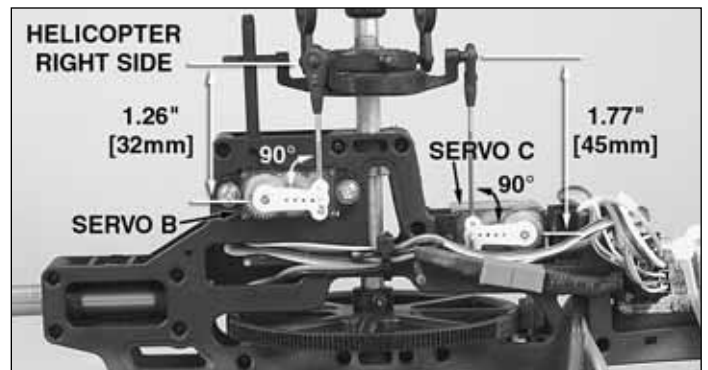

Servo arms are perfectly level when the throttle stick is all the way down in normal mode (Idle Up OFF). Helicopter right side Servo B pushrod length should be 1.26" [32mm] and Servo C pushrod length should be 1.77" [45mm].

Tail Rotor Replacement

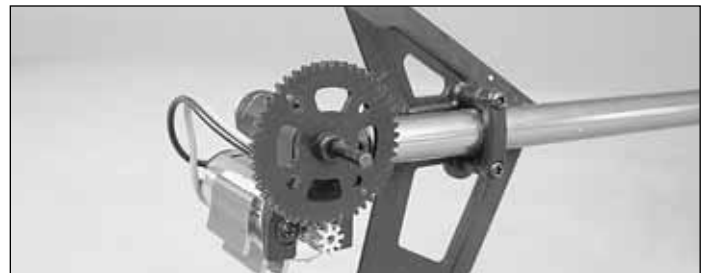
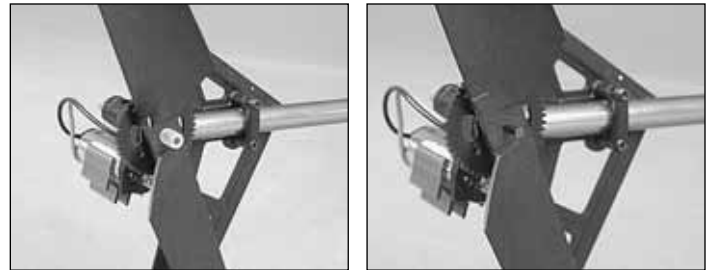

Remove the small piece of silicone tubing from the tail rotor shaft. Slide the tail rotor off of the shaft. Please notice there are two pins protruding from the back side of the tail rotor. These two pins must be aligned with the holes in the drive gear. Simply slide the new tail rotor onto the shaft aligning the pins with the drive gear. Press the silicone tubing back onto the shaft. Make certain there is no end gap on the tail rotor shaft once you are done.

Spindle Replacement



Use a 1.5mm hex wrench to remove a spindle screw. Remove the linkages from the blade grips and rotate both blade grips straight down. On the side where you removed the spindle screw, carefully remove the blade grip by pulling outward.

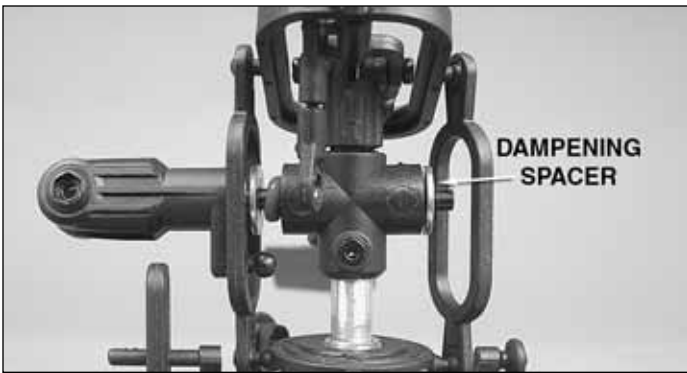

Remove the dampening spacer. Pull on the other blade grip and remove the spindle and blade grip. If the O-rings come loose simply press them back into the head block.



New spindle installation. Apply threadlocking compound to one of 2mm screws. Slide the 2mm washer onto the screw and thread it into the spindle. Slide one of the blade grips onto the spindle followed by one of the dampening spacers.



Using a 1.5mm hex wrench, slide the blade grip and spindle assembly through the head block. Make certain the O-rings are properly seated and they do not slide out the other side.

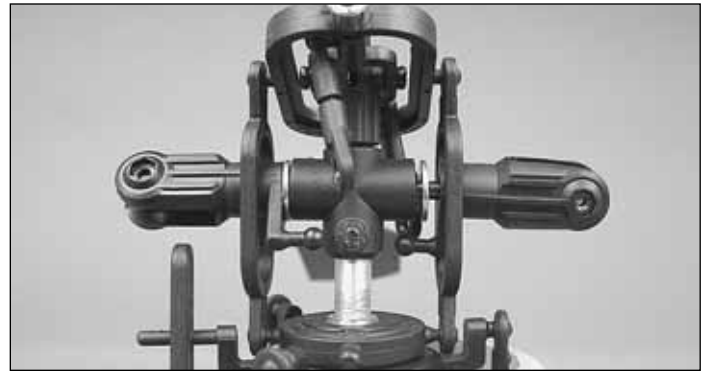

Place the other dampening spacer and blade grip onto the spindle. Apply threadlocking compound to the remaining 2mm spindle screw. Slide a 2mm washer onto the screw and install into the spindle. Using two 1.5mm hex wrenches tighten the spindle bolts.



Snap the ball links onto the blade grips and re-install the main blades.

Main Shaft Removal

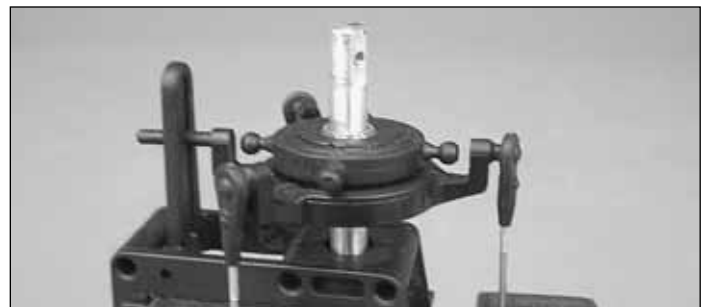
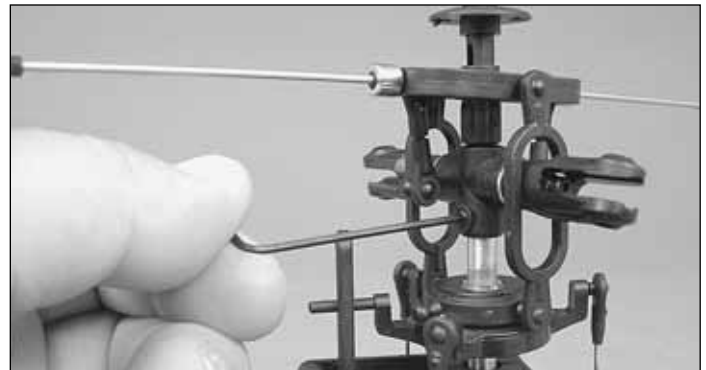

Remove the main rotor blades. Use a 1.5mm hex wrench to remove the head block retaining bolt. Using a pair of ball link pliers remove the oval links from the swashplate. While holding onto the main gear pull upward on the main rotor head assembly. If the head is difficult to remove simply try to rotate the main rotor head back and forth while holding onto

the main gear. Please note there is a flat spot on the main shaft, you will not be able to rotate the head more than a few degrees due to this.

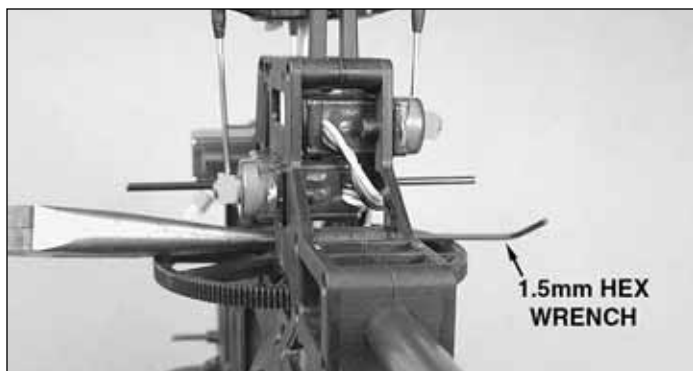

Use pliers to grasp the 2mm nut on the main gear. Insert a 1.5mm hex wrench into the main gear bolt and remove the screw.



Insert a 1.5mm hex wrench into the main shaft collar set screw and loosen. Insert another 1.5mm hex wrench into the hole in the top of the main shaft. While holding onto the main gear try pulling upwards on the main shaft. If you are having difficulty removing the main shaft make certain you have loosened the set screw on the main shaft collar. If necessary try rotating the main shaft back and forth to help pull the shaft loose from the lower gear. If you decide to remove the main gear please note there is a small spacer located beneath it.

Main Shaft Installation

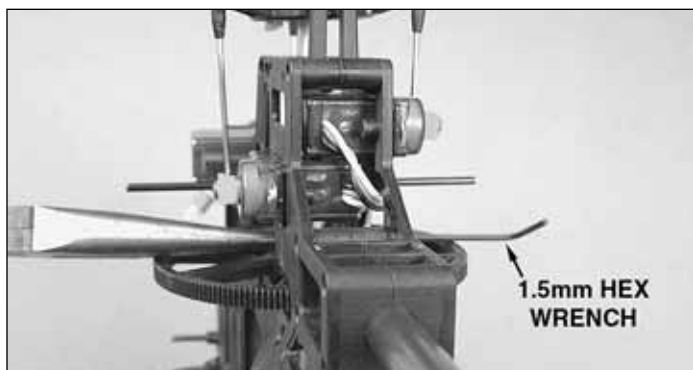

Using the 1.5mm hex wrench and pliers to hold the nut. Re-install the lower main shaft bolt.



Insert a 1.5mm hex wrench into the main shaft collar set screw. While pushing downward on the main shaft and pull upward on the main shaft collar and tighten the set screw. There should be no vertical movement in the main shaft once you have completed this step.

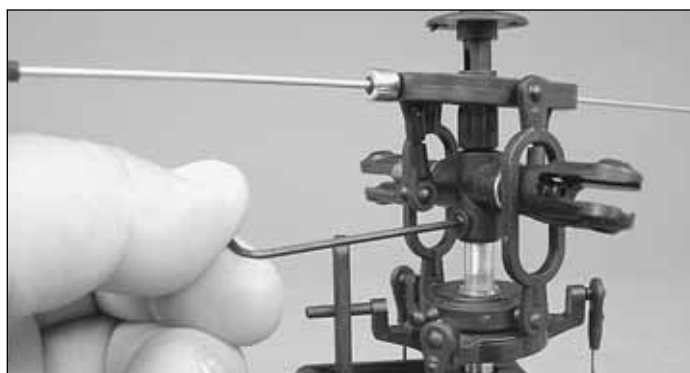

Slide the main rotor head block back onto the main shaft. Make certain the flat spot inside of the head block is aligned with the flat spot on the main shaft. Use a 1.5mm hex wrench to re-install the 2mm bolt head bolt.



This section is provided to help you install the optional Futaba® GY240 AVCS heading hold gyro in the Heli-Max AXE Mini EP RTF. This section may be omitted if you do not intend to install this gyro.

Items Needed (must be purchased separately):

- (1) Futaba GY240 AVCS Gyro (FUTM0809)
- (1) Great Planes® ElectriFly™ C-12 Micro Brushed ESC w/BEC (GPMM2015)
- (1) W.S. Deans® Micro 2R Plug (WSDM3007) (for C-12 ESC)
- (2) Small Tie Wraps

Optional Items:

- (1) Great Planes LiPo 910mAh 11.1V 3s 15C Discharge Deans battery (GPMP0815)
- (1) W.S. Deans 2-Pin Ultra Plug™ WSDM3001

Tools:

Solder and Soldering Iron
Wire Cutters

Installing a heading hold gyro into the Heli-Max AXE Mini EP RTF will make the model easier to fly. The gyro will now allow you to focus your concentration on the other controls instead of constantly flying the tail.

We highly recommend using the optional Great Planes LiPo 11.1V 3s 15C battery (GPMP0815) for the best overall performance. This battery provides a longer flight time and higher power output in comparison to the stock NiMH battery.

Installing the Gyro

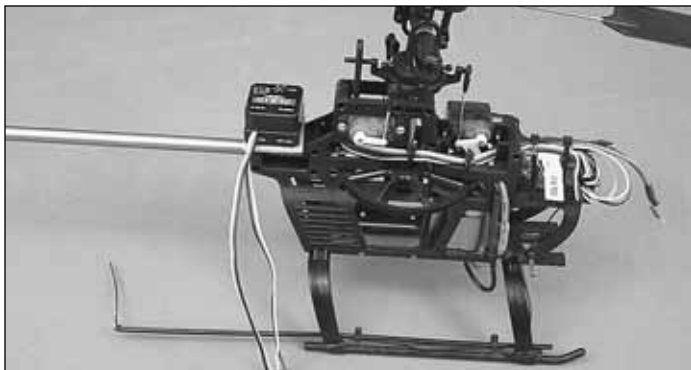

Use alcohol and a paper towel to remove any grease or mold release agents on the gyro and helicopter frame. Apply the double-sided foam mounting tape included with the gyro to the bottom of the unit. Carefully align the gyro as shown in the picture and mount the gyro onto the helicopter frame.



Solder a Micro Deans plug onto the motor wires of the C-12 ESC as shown. The negative (-) motor lead (blue wire) connects to the male pin on the connector. This will be connected to the tail motor in a later step.

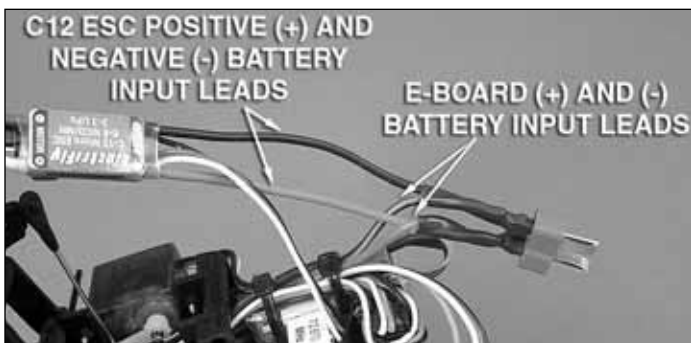

It will be necessary to solder the E-Board and C-12 ESC to the battery connector as shown above. If you decide to use the Great Planes 910mAh LiPo battery (GPMP0815), we suggest

installing a Deans Ultra Male Plug onto the ESC and E-Board to match the connector on the battery pack. The Deans Ultra Plug will better handle the increased current draw of more aggressive flight as your skill level advances.

Using wire cutters, remove the Deans Micro connector from both battery input leads on the E-Board and the C-12 ESC. Remove 1/4" [6mm] of wire insulation from both the positive (+) and negative (-) leads of the C-12 ESC and E-Board.

Compare the battery pack connector to the ESC connector and verify the polarity is correct before soldering. Twist and solder together the positive battery lead from the C-12 ESC and the positive lead from the E-Board. Slide the supplied heat-shrink tubing (included with the Deans Ultra Plug) over the wires and solder them to the Deans connector. Repeat for the negative lead. Slide the heat-shrink tubing up the wire to the plug. Use heat to shrink the tubing.

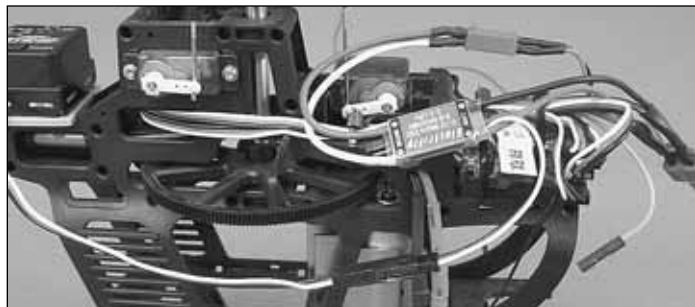

Disconnect the tail motor plug as shown above and connect the plug directly into the blue and white motor wires on the C-12 ESC.

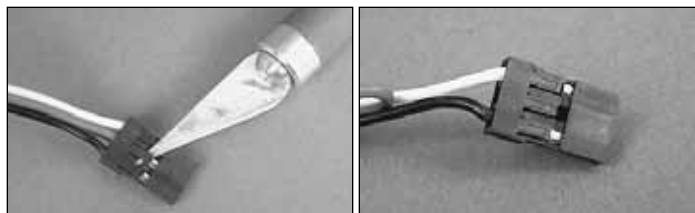

Since the E-Board provides power to the receiver and servos, the BEC in the C-12 ESC must be disabled.

Carefully lift up the plastic tab on the C-12 ESC connector, remove the red pin from the plug, and fold it back over the wire. Wrap a piece of electrical tape or heat-shrink tubing around the connector pin and wire. Plug the C-12 ESC into the GY240 gyro.



Remove the orange wire from the receiver and plug the GY240 into the same position. Verify the black wire (-) on the connector is towards the outside edge of the receiver. Now plug the orange connector into the next available position on the receiver (channel 5), and align it with the column of white wires on the other connectors.



Use two tie straps to attach the gyro wires to the frame. Bundle the wires and ESC together at the front of the helicopter.



On the gyro, set the "AVCS" switch to "ON" and set the "DIR" switch to "REV". Set the gain to 60% using the adjustment dial on the gyro. If necessary, adjust the gain to match your flying style or desired setup. The typical range of gain is 50% to 75%.

Review your work and verify that none of the wires can get caught in the main rotor gear or the swashplate. The helicopter is now ready for the test flight.

Flight Initialization

If this is your first time flying a heading hold gyro, be sure to take your time and become accustomed to the new gyro before jumping into your normal flying routine.

Turn on the transmitter, center the tail rotor trim tab, extend the antenna, and verify the idle up switch is "OFF" (toward the back of the transmitter). Connect the flight battery and allow the gyro 10 seconds to initialize. The helicopter and tail rotor stick must remain still during this process.

Arming the Tail ESC

The tail motor ESC must be armed before each flight. The best time to do this is after you place the helicopter on the ground before taking off.

You will hear three beeps from the tail ESC once the gyro has initiated. Carefully apply full right tail rotor and you will hear 4 beeps. Apply full left tail rotor and you will hear another set of beeps. The tail ESC and motor are now armed and you are ready to fly. If you need to pick up the helicopter, firmly hold onto the main frame since the tail motor could operate at any time. You can hold full left tail rotor on the transmitter to prevent this from occurring.

Flying

If the tail wants to drift slowly due to wind gusts, your gain may be set too low. Increase the gain a small amount and see if performance improves.

If the tail has a tendency to oscillate from left to right, your gain may be set too high. Reduce the gain and see if performance improves.

GOOD LUCK AND GREAT FLYING!

This model belongs to:

Name
Address
City, State Zip
Phone number
AMA number

Make a copy of this identification tag and put it on or inside your model.

AXE Mini EP RTF Parts List

Key #	SKU	Description	# of pcs.
04	HMXM1002	NiMH Battery 650mAh, 10.8V	1
05	HMXE4703	Antenna Tube	1
01	HMXE7420	Canopy White	1
03	HMXE7426	Canopy Grommets	2
35	HMXE8607	Center Hub	1
37	HMXE8606	Control Hub Pin	2
06	HMXE8605	Canopy Mounts	3
52	HMXM2005	Receiver	1
53	HMXM2003	E-Board (Mixer, Gyro, ESC)	1
50	HMXE7802	Flybar Links	2
34	HMXE7806	Feathering Spindle	1
42	HMXE7805	Flybar Weights	2
43	HMXE7803	Flybar	1
39	HMXE7804	Flybar Paddles	2
49	HMXE8621	Head Bolt and Nut	2
40	HMXE8622	Head Button	1
31	HMXE7627	Linkage Set	5
48	HMXE7362	O-Ring Set	4
46	HMXE8308	Main Rotor Blades	2
47	HMXE8313	Main Blade Grips	2
10	HMXE8407	Main Frame	2
54	HMXE8002	Main Motor, 380	1
44	HMXE8403	Main Rotor Shaft Bushing	2
51	HMXE8404	Main Rotor Gear	1
30	HMXE8405	Main Shaft Collar and Bushing	3
32	HMXE8406	Main Shaft	1
25	HMXE7301	Replacement Bearing Set	8
8	HMXE7342	Screw Set	40
38	HMXE8801	Seesaw	1
28	HMXE8701	Silicone Secure Tubes	4
07	HMXE8901	Skids	2
09	HMXE8902	Skid Supports	2
36	HMXE9058	Slide Block	1
41	HMXE8813	Stabilizer Control Hub	1
33	HMXE9001	Swashplate Assembly	1
14	HMXE9002	Swashplate Stay	1
11	HMXM2004	Servo	1
12	HMXE8814	Servo Mounting Screws	6
13	HMXE8818	Servo Arms w/screws	6
16	HMXE9550	Tail Boom	1
17	HMXE9551	Tail Fin Support Rod	1
21	HMXE9553	Tail Motor	1
5	HMXE9554	Tail Motor Extension Wire	1
23	HMXE9555	Tail Motor Mount	1
24	HMXE9556	Tail Motor Screws	2

Key #	SKU	Description	# of pcs.
27	HMXE9557	Tail Rotor Blade	1
26	HMXE9558	Tail Rotor Gear	1
22	HMXE9559	Tail Rotor Shaft	1
19	HMXE9560	Tail Shaft	1
29	HMXE9561	Tail Vertical Fin Bracket w/screws	3
18	HMXE9562	Tail Vertical Fin	1
45	HMXE9900	Washer Set	4
20	HMXE8623	Heat Sinks	2
02	HMXE8819	Battery Rubber Bands	3
	HMXE7508	Decal Set	
	HMXE9552	Training Gear	2
	HMXP1003	Wall Charger	1
	HMXZ7006	Instruction Manual	1

Optional Parts

Key #	SKU	Description
18	HMXE7450	Carbon Fiber Vertical Fin w/mounting hardware
	HMXE7451	Carbon Fiber Horizontal Fin w/mounting hardware
39	HMXE7452	Carbon Fiber Flybar Paddles
16	HMXE7453	Carbon Fiber Tail Boom
33	HMXE7454	CNC Swashplate Assembly
35, 40	HMXE7455	CNC Center Hub & Head Button
36, 37	HMXE7456	CNC Slide Block & Seesaw
41	HMXE7657	CNC Flybar Carrier
47	HMXE7658	CNC Main Blade Grips
	GPMP0815	Great Planes ElectriFly™ 910mAh, 11.1V LiPo Battery

Detailed View of Rotor Head

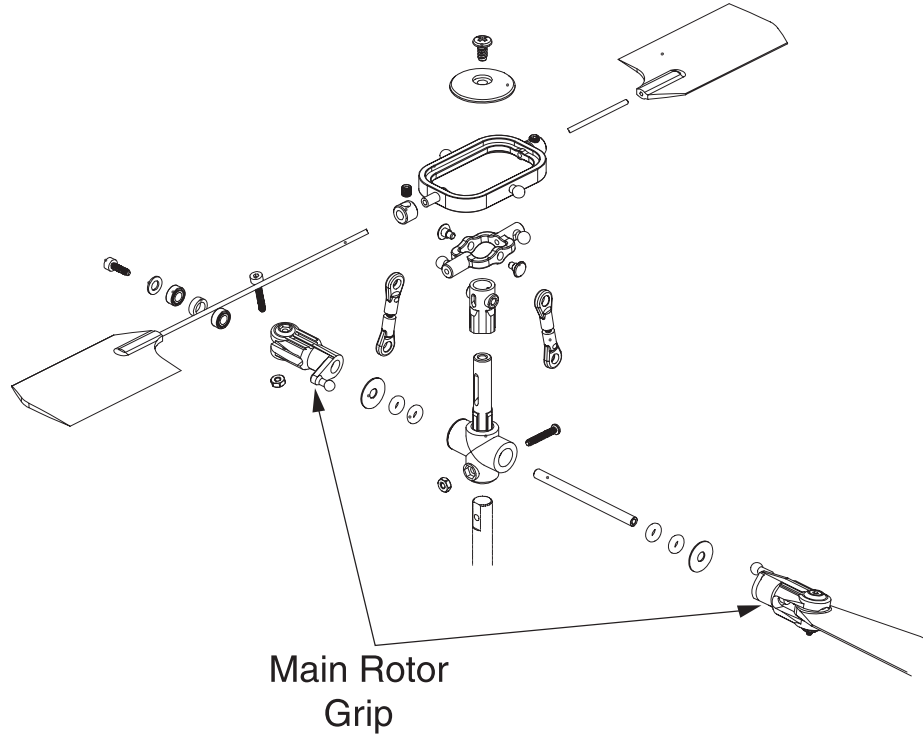





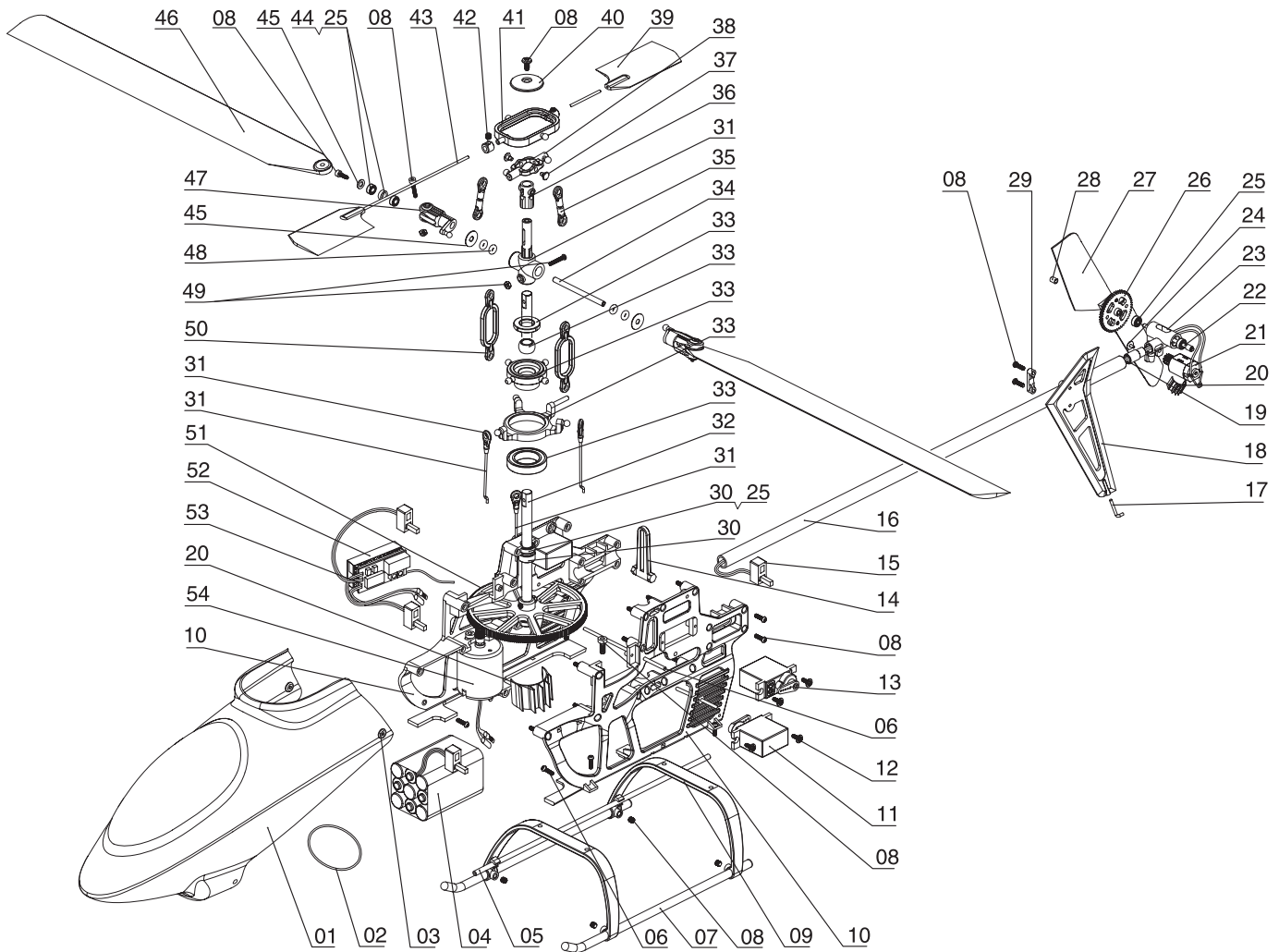



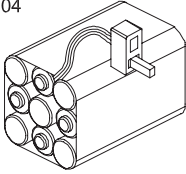

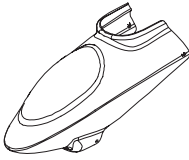

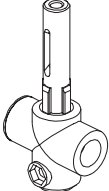
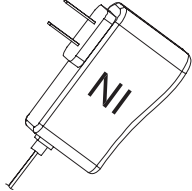

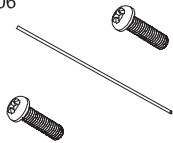
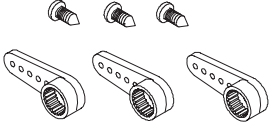
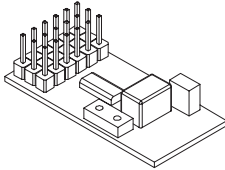
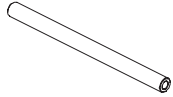

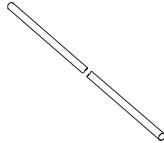
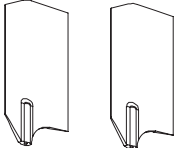
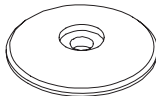
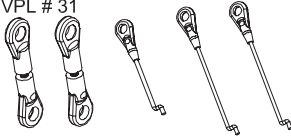

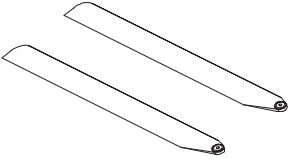
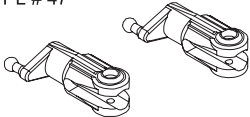
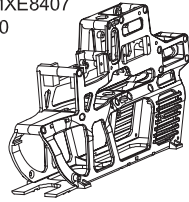
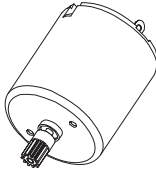
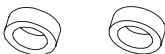
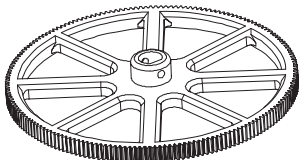
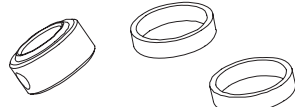
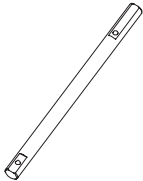
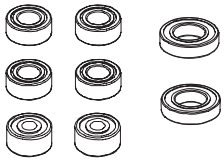
Main Rotor Grip

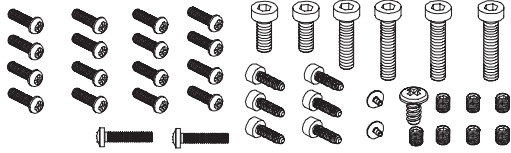
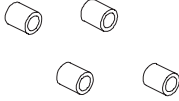
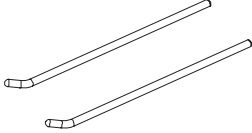
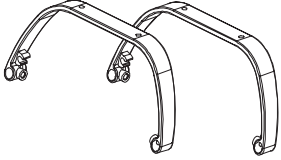
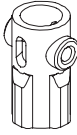
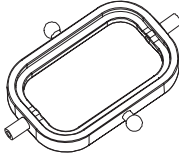
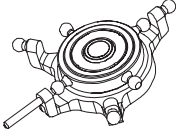
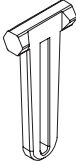
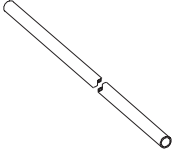
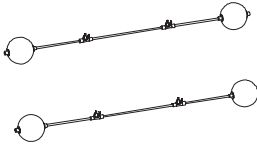
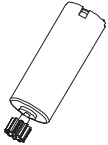
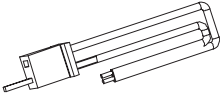
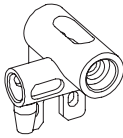
Exploded View

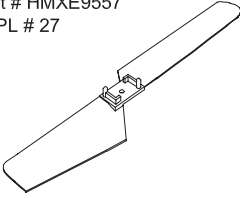
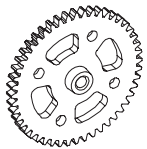

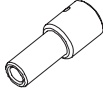
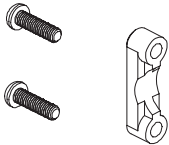
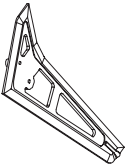
Parts Images

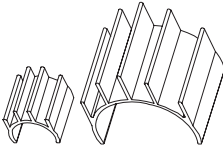
<p>NiMH Battery, 650mAh 10.8V Part # HMXM1002 EVPL # 04</p> 	<p>Antenna Tube Part # HMXE4703 EVPL # 05</p> 	<p>Canopy Part # HMXE7420 EVPL # 01</p> 	<p>Canopy Grommets Part # HMXE7426 EVPL # 03</p> 
<p>Center Hub Part # HMXE8607 EVPL # 35</p> 	<p>Wall Charger Part # HMXP1003</p> 	<p>Control Hub Pin Part # HMXE8606 EVPL # 37</p> 	<p>Canopy Mounts Part # HMXE8605 EVPL # 06</p> 
<p>Servo Arms with screws Part # HMXE8818 EVPL # 13</p> 	<p>Receiver Part # HMXM2005 EVPL # 52</p> 	<p>Flybar Links Part # HMXE7802 EVPL # 50</p> 	<p>Feathering Spindle Part # HMXE7806 EVPL # 34</p> 
<p>Flybar Weights Part # HMXE7805 EVPL # 42</p> 	<p>Flybar Part # HMXE7803 EVPL # 43</p> 	<p>Flybar Paddles Part # HMXE7804 EVPL # 39</p> 	<p>Head Bolt and Nut Part # HMXE8621 EVPL # 49</p> 
<p>Head Button Part # HMXE8622 EVPL # 40</p> 	<p>Linkage Set Part # HMXE7627 EVPL # 31</p> 	<p>O-Ring Part # HMXE7362 EVPL # 48</p> 	<p>Main Rotor Blades Part # HMXE8308 EVPL # 46</p> 
<p>Main Blade Grips Part # HMXE8313 EVPL # 47</p> 	<p>Main Frame Part # HMXE8407 EVPL # 10</p> 	<p>Main Motor, 380 Part # HMXE8002 EVPL # 54</p> 	<p>Main Rotor Shaft Bushing Part # HMXE8403 EVPL # 44</p> 
<p>Main Rotor Gear Part # HMXE8404 EVPL # 51</p> 	<p>Main Shaft Collar and Bushing Part # HMXE8405 EVPL # 30</p> 	<p>Main Shaft Part # HMXE8406 EVPL # 32</p> 	<p>Replacement Bearing Set Part # HMXE7301 EVPL # 25</p> 

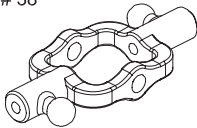
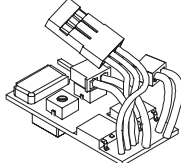
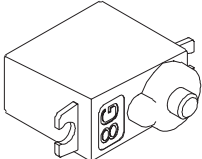
<p>Screw Set Part # HMXE7342 EVPL # 8</p> <p>40 PCS</p> 	<p>Silicon Secure Tubes Part # HMXE8701 EVPL # 28</p> <p>4 PCS</p> 	<p>Skids Part # HMXE8901 EVPL # 07</p> <p>2 PCS</p> 	
<p>Skid Supports Part # HMXE8902 EVPL # 09</p> <p>2 PCS</p> 	<p>Slide Block Part # HMXE9058 EVPL # 36</p> <p>1 PC</p> 	<p>Stabilizer Control Hub Part # HMXE8813 EVPL # 41</p> <p>1 PC</p> 	<p>Swashplate Assembly Part # HMXE9001 EVPL # 33</p> <p>1 SET</p> 
<p>Swashplate Stay Part # HMXE9002 EVPL # 14</p> <p>1 PC</p> 	<p>Tail Boom Part # HMXE9550 EVPL # 16</p> <p>1 PC</p> 	<p>Training Gear Part # HMXE9552</p> <p>2 PCS</p> 	<p>Tail Motor Part # HMXE9553 EVPL # 21</p> <p>1 PC</p> 
<p>Tail Motor Extension Wire Part # HMXE9554 EVPL # 15</p> <p>1 PC</p> 	<p>Tail Motor Mount Part # HMXE9555 EVPL # 23</p> <p>1 PC</p> 	<p>Tail Motor Screws Part # HMXE9556 EVPL # 24</p> <p>2 PCS</p> 	<p>Tail Rotor Blade Part # HMXE9557 EVPL # 27</p> <p>1 PC</p> 
<p>Tail Rotor Gear Part # HMXE9558 EVPL # 26</p> <p>1 PC</p> 	<p>Tail Rotor Shaft Part # HMXE9559 EVPL # 22</p> <p>1 PC</p> 	<p>Tail Shaft Part # HMXE9560 EVPL # 19</p> <p>1 PC</p> 	<p>Tail Vertical Fin Bracket with Screws Part # HMXE9561 EVPL # 29</p> <p>3 PC</p> 
<p>Tail Vertical Fin Part # HMXE9562 EVPL # 18</p> <p>1 PC</p> 	<p>Washer Set Part # HMXE9900 EVPL # 45</p> <p>4 PCS</p> 	<p>Heat Sinks Part # HMXE8623 EVPL # 20</p> <p>2 PCS</p> 	<p>Servo Mounting Screws Part # HMXE8814 EVPL # 12</p> <p>6 PCS</p> 
<p>Tail Fin Support Rod Part # HMXE9551 EVPL # 17</p> <p>1 PC</p> 	<p>Seesaw Part # HMXE8801 EVPL # 38</p> <p>1 PC</p> 	<p>E-Board (Mixer, Gyro, Exc) Part # HMXM2003 EVPL # 53</p> <p>1 PC</p> 	<p>Servo Part # HMXM2004 EVPL # 11</p> <p>1 PC</p> 

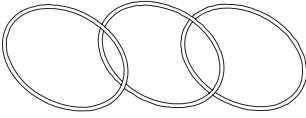
<p>Battery Rubber Bands 3 PCS Part # HMXE8819 EVPL # 02</p> 			
--	--	--	--

Optional Parts Images

<p>CF 3D Vertical Fin with Mounting Hardware 1 SET Part # HMXE7450</p> 	<p>CF 3D Horizontal Fin with Mounting Hardware 1 SET Part # HMXE7451</p> 	<p>CF Flybar Paddles 2 PCS Part # HMXE7452</p> 	<p>CF Tail Boom 1 SET Part # HMXE7453</p> 
<p>CNC Swashplate Assembly 1SET Part # HMXE7454</p> 	<p>CNC Center Hub & Head Button 1SET Part # HMXE7455</p> 	<p>CNC Slide Block and Seesaw 1SET Part # HMXE7456</p> 	<p>CNC Flybar Carrier 1SET Part # HMXE7657</p> 
<p>CNC Main Blade Grips 2 SET Part # HMXE7658</p> 	<p>CF Main Rotor Blades 2 PCS Part # HMXE4269</p> 	<p>ElectriFly™ 11.1V 910mAh 15C Balance BP910 LiPo Battery 1SET Part # GPMP0709</p> 	<p>ElectriFly PolyCharge™ LiPo Charger 1SET Part # GPMM3010</p> 
<p>ElectriFly Triton2™ Charger 1SET Part # GPMM3153</p> 	<p>DuraTrax® IntelliPeak™ ICE Charger 1SET Part # DTXP4170</p> 	<p>ElectriFly Triton™ Jr. Charger 1SET Part # GPMM3152</p> 	