

Santa Cruz Instructions

Parts Drawing

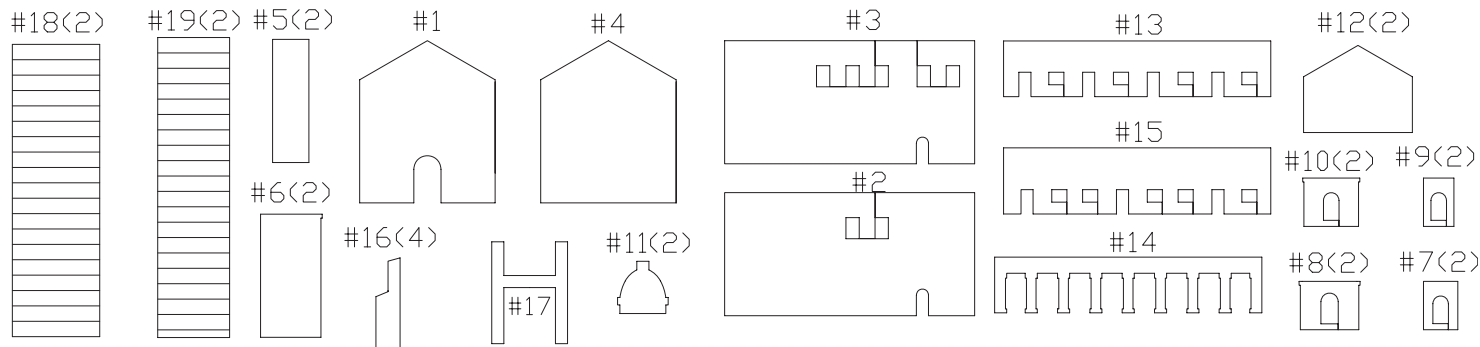

- Before starting assembly, read through each step of the instructions and carefully study each photo. As you put the model together, it is a good idea to "test" fit the pieces together before using any glue.
- Spread out newspaper across the table or desk that you are working on. This will help to protect your work surface.
- Use scissors to trim any pieces where needed. PARENTAL SUPERVISION is recommended.
- Identify each piece of the model by matching it with the parts drawing above.
- Assemble the model with standard white glue. It is a good idea to hold the pieces together with toothpicks until the glue is dry. Once the glue is dry, twist the toothpick and carefully pull it out.
- Use a small brush, flat stick, or your finger to spread glue evenly on the surface.
- Do not glue any of the pieces to the base until after Step 8.

Note: The missions can either be assembled on the cardboard sheet (included) or on a sheet of foam (not included).

ASSEMBLY INSTRUCTIONS

1. Place the 24" x 15" base on a clean, flat surface.
2. Apply glue along the front edges of #2 and #3 and place them against #1 as shown below. Apply glue on the rear edges of both #2 and #3 and put #4 in place. Make sure all edges are even. This section will be called the "main building."

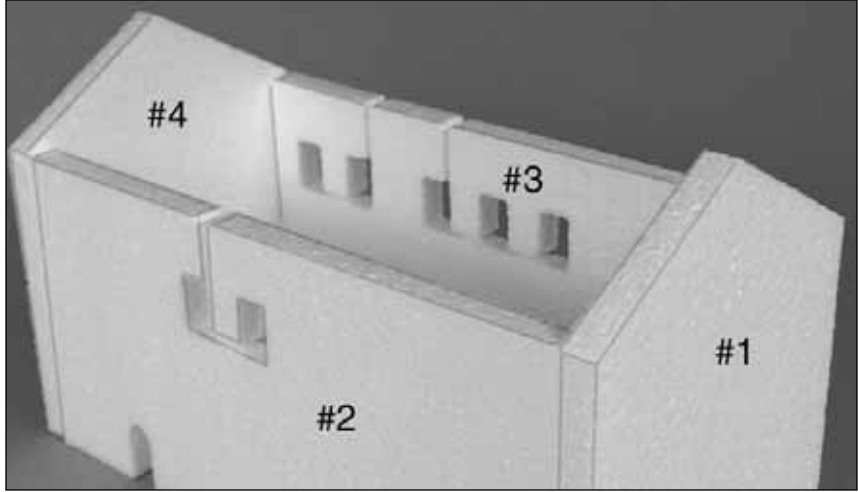
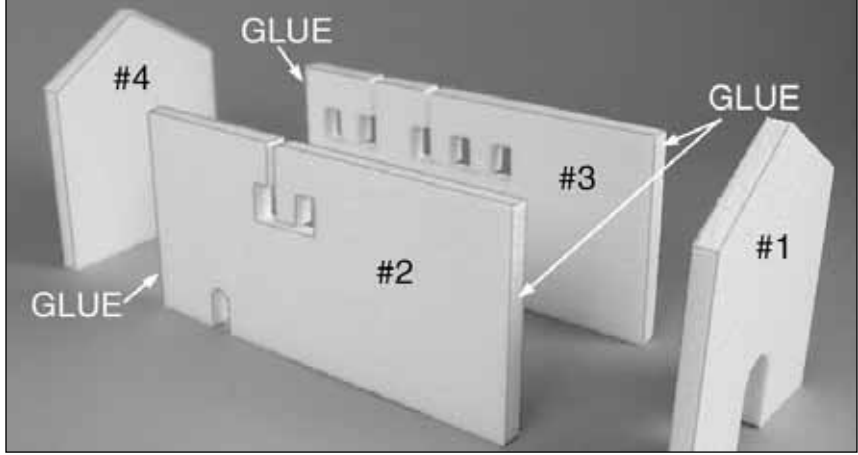

3. Locate both #5 pieces and both #6 pieces. Glue them together as shown below. Make sure the edges are even.

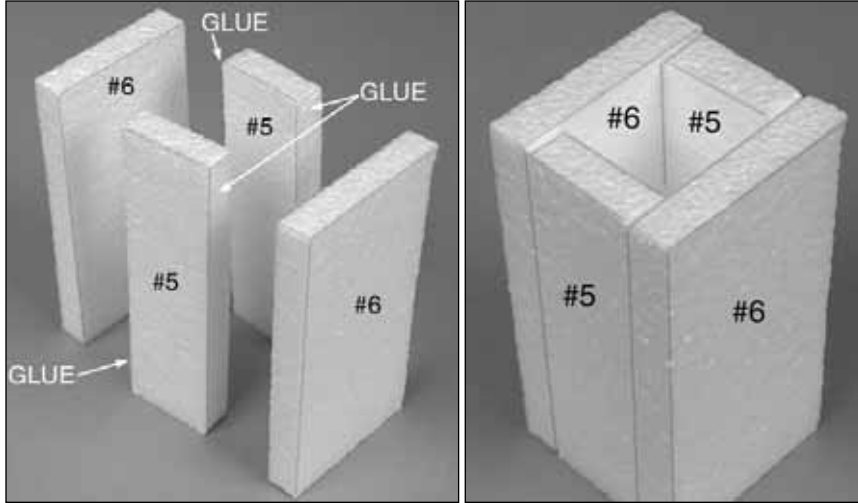

4. Locate both #7 pieces and both #8 pieces. Glue them together as shown in the two photos that follow and glue them into place on top of the #5 - #6 assembly.

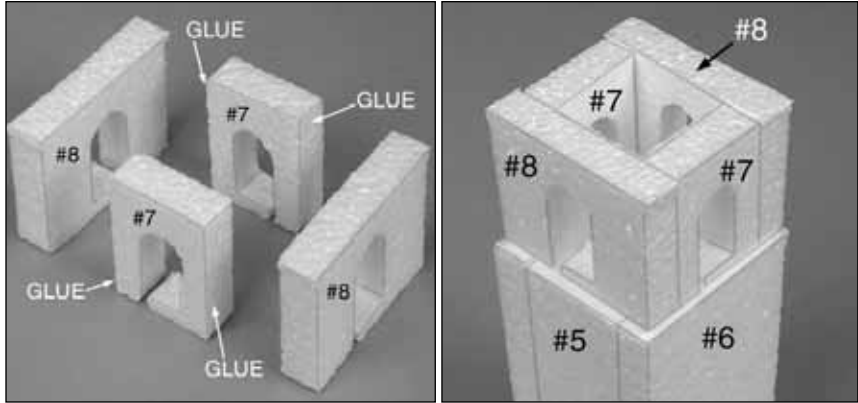

5. Locate both #9 pieces and both #10 pieces. Glue them together as shown below and glue them into place on top of the #7 - #8 assembly.

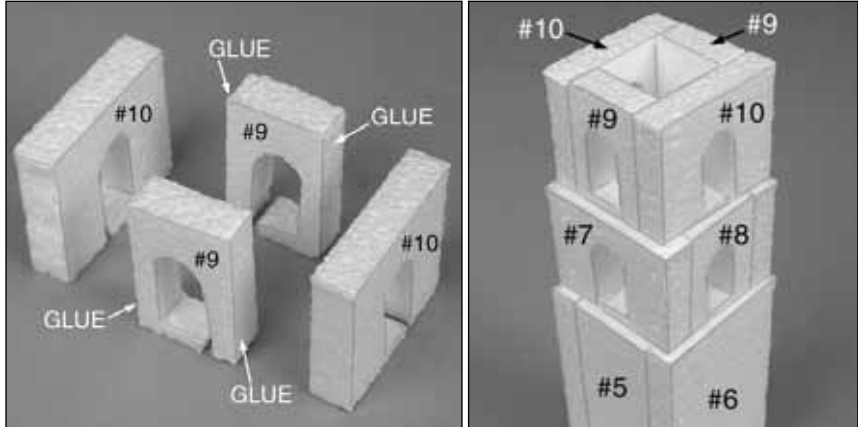

6. Locate both #11 pieces and glue them together as shown and then glue them in place on top of the #9 - #10 assembly. This section will be called the "bell tower."

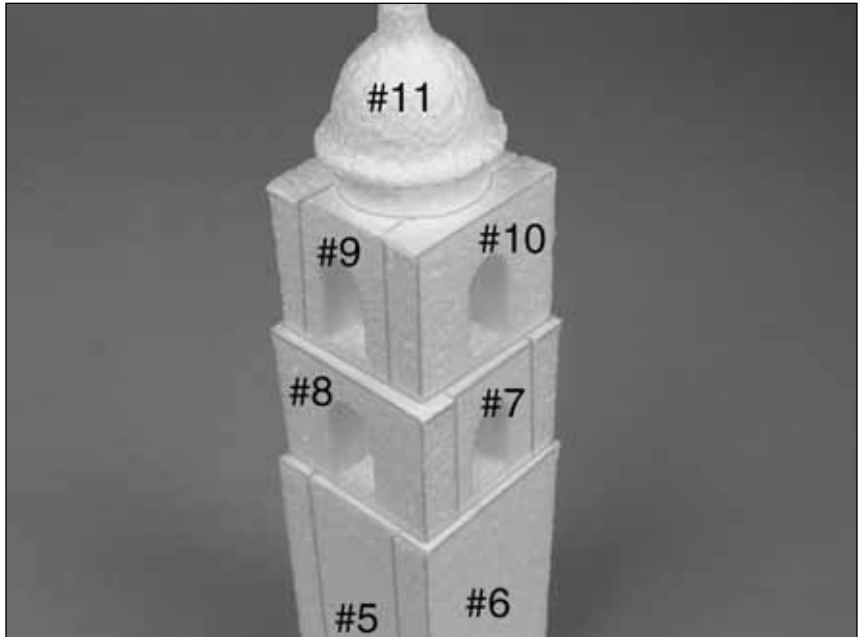

7. Locate both #12 pieces, along with #13 and #14, and glue them together as shown below. Make sure all edges meet evenly.

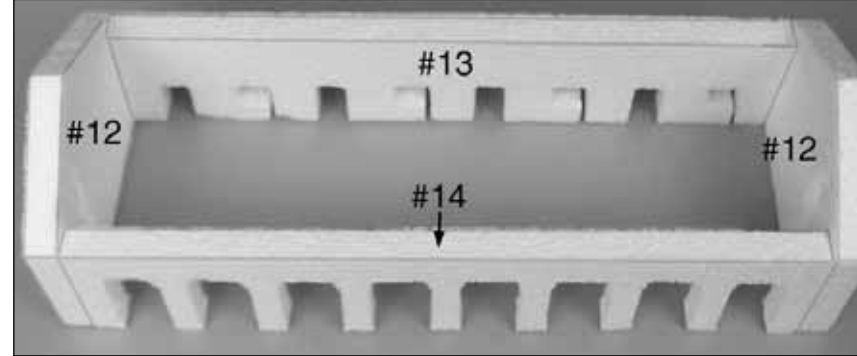
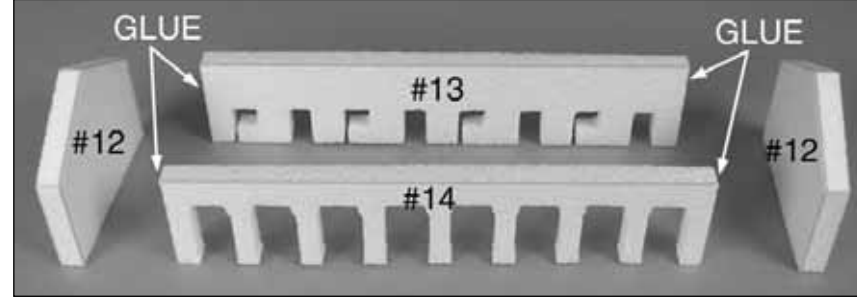

8. Glue #15 into place 5/8" back of #14 as shown. This section will be called the "quarters."

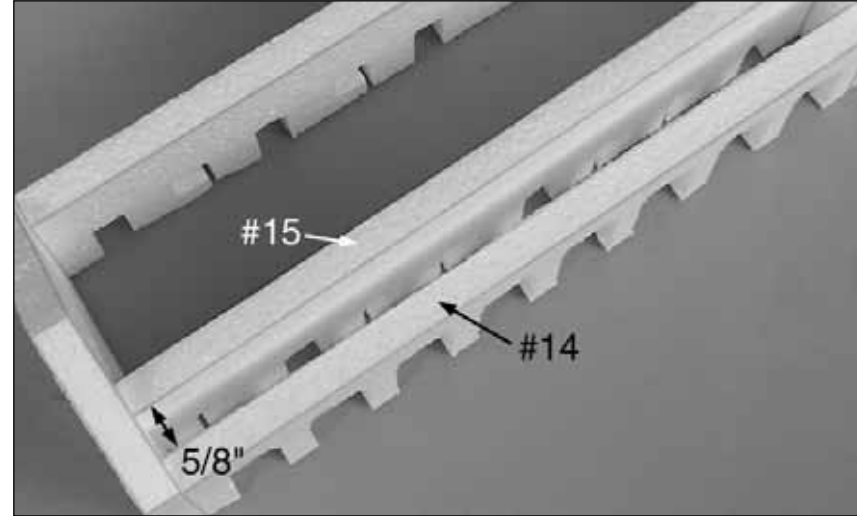

9. Now the basic sections can be glued to the base. Glue the main building in place so that the front door is 2" from the front of the base and the right side of the main building is 4" from the edge of the base as shown in the photos that follow. Glue the bell tower so that it is 1-3/4" back from the front edge of the main building. Glue the quarters in place so that the front wall meets up evenly with the main building as shown. This will leave you enough room to create scenery for your model.

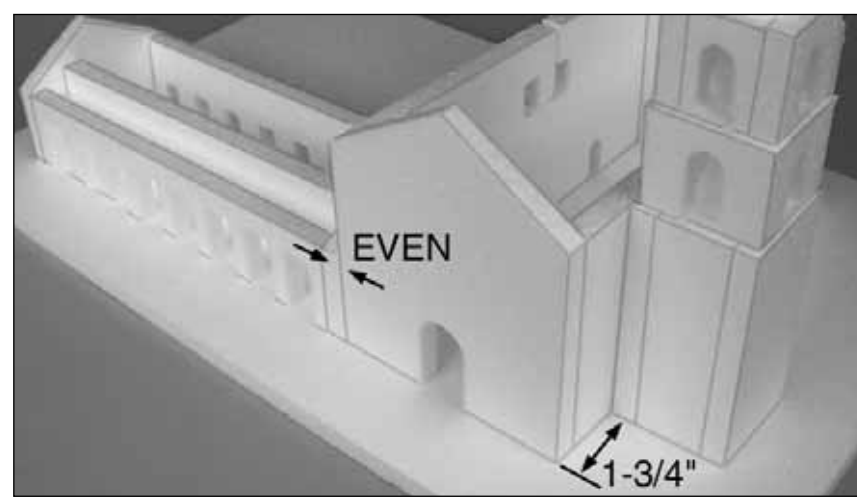
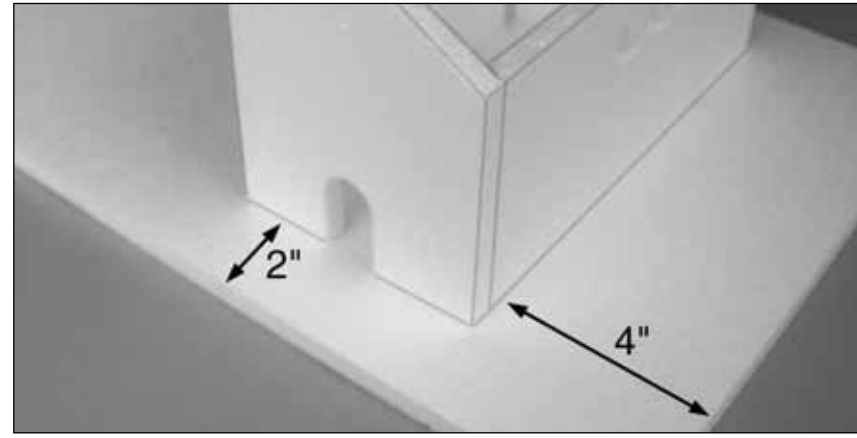

10. Locate the four #16 pieces. Glue them together as shown so that you have two columns. Glue them into place on the front of the main building as shown. Make sure all edges meet evenly.

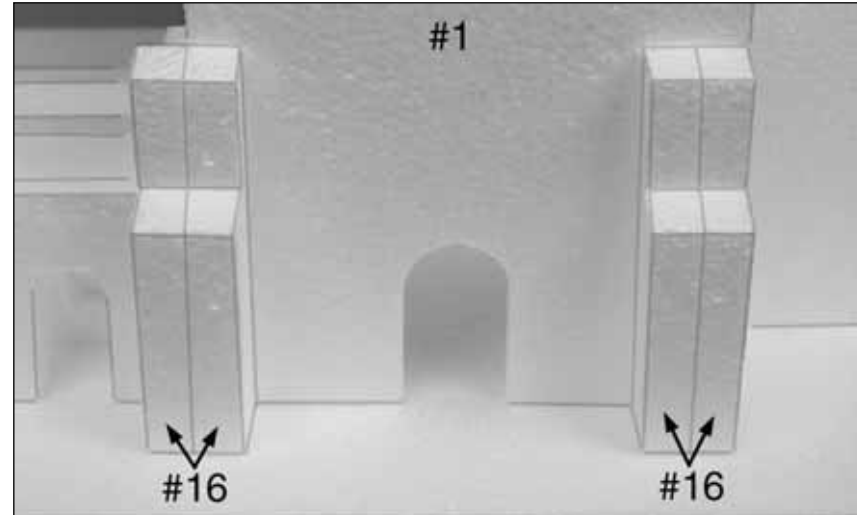

11. Glue #17 into place over the doorway as shown below.

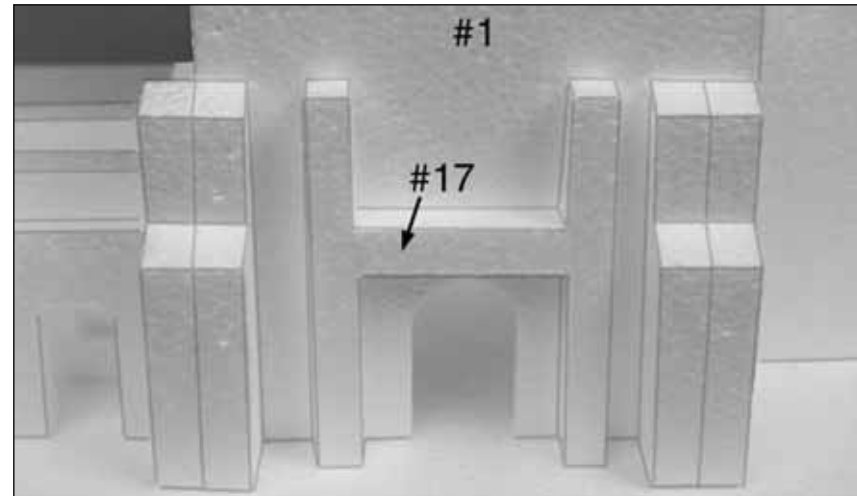

12. Locate both #18 pieces. This is the roof of the main building. You will need to cut a small portion off of the right roof piece so that it will fit tightly against the bell tower. Put the right side of the roof in place so that there is 3/8" overhang on the front and back. Make two marks where the bell tower meets the roof. Using scissors, cut away about 1/2" of foam away between the marks as shown below. Apply glue along the top edges of the main building and put the roof pieces in place.

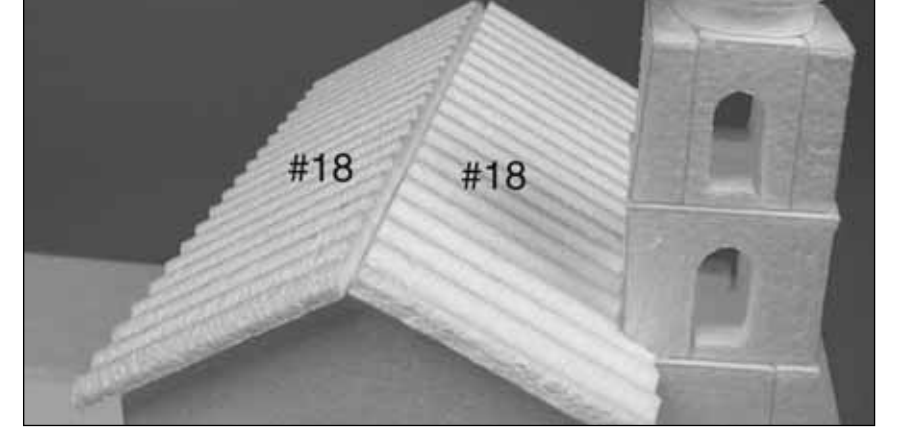
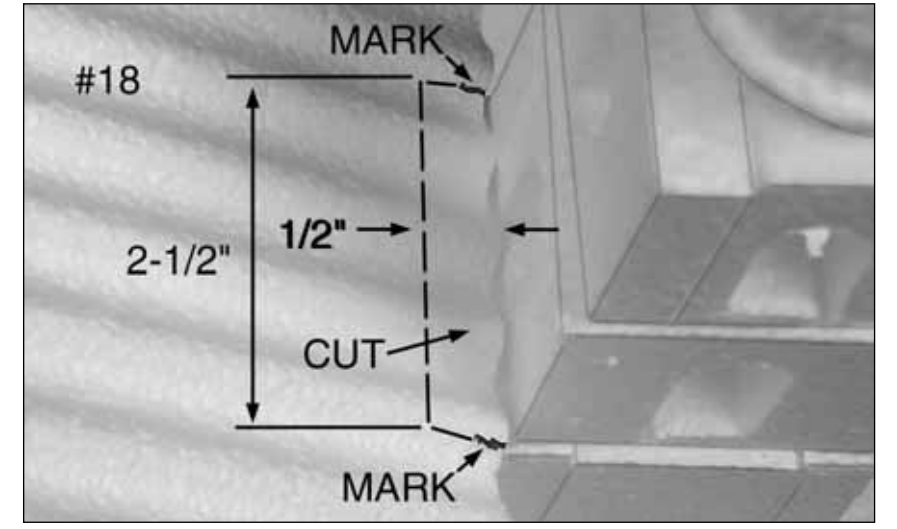

13. Locate both #19 pieces. This is the roof of the quarters. You will need to cut a small portion off of the front roof piece so that it will fit tightly against the column. Put the front piece of the roof in place so that it is against the main building. Make a mark where the pillar meets the roof. Using scissors, cut away about 3/8" of foam between the mark and the edge as shown below. Apply glue along the top edges and put the roof pieces in place.

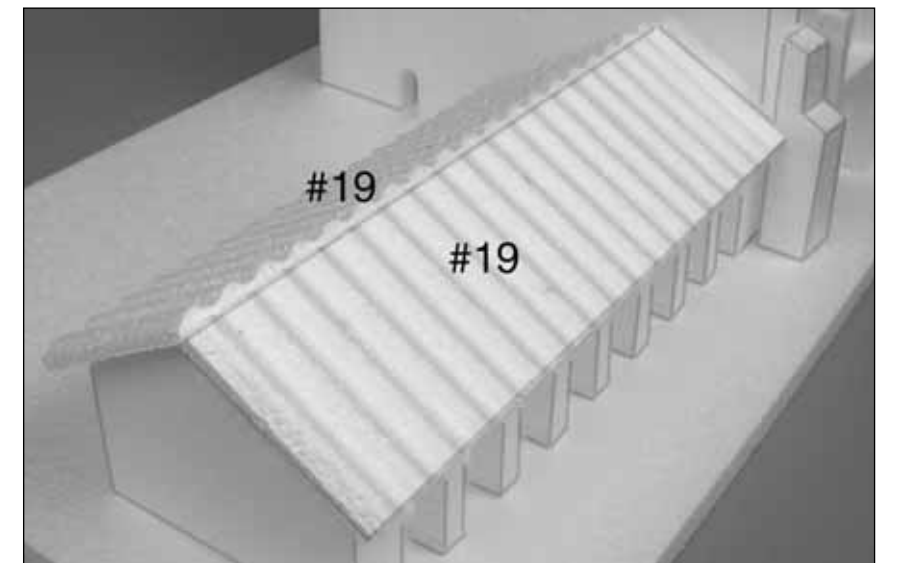
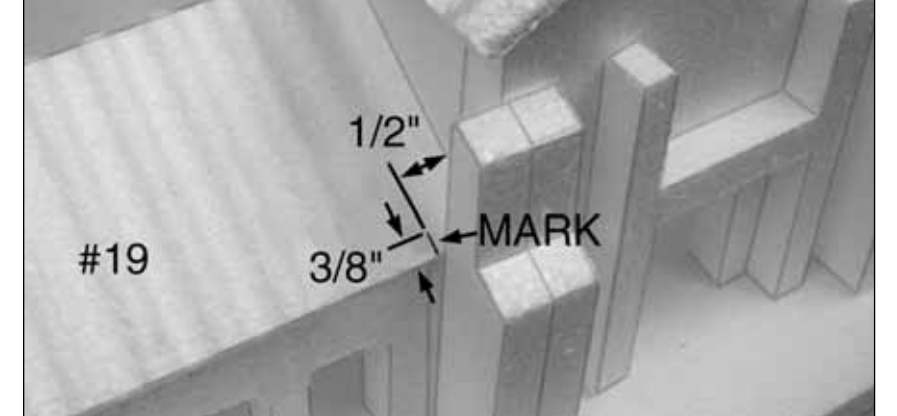

FINISHING

- When you paint your model, use only water-based paints.
- Check with your favorite hobby dealer for accessories such as grass, shrubbery, grave markers, action figures...etc. that will add realism to your model.