

San Rafael Instructions

Parts Drawing

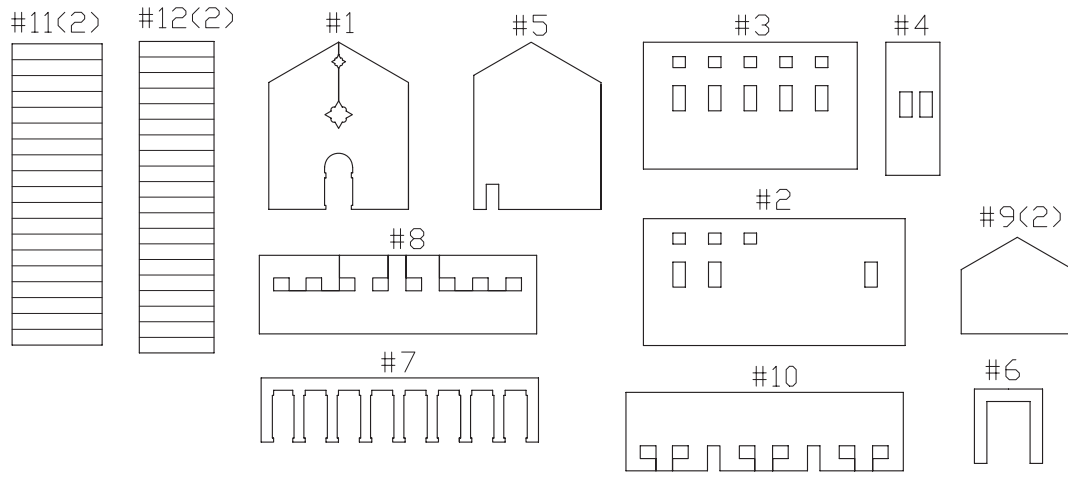

- Before starting assembly, read through each step of the instructions and carefully study each photo. As you put the model together, it is a good idea to "test" fit the pieces together before using any glue.
- Spread out newspaper across the table or desk that you are working on. This will help to protect your work surface.
- Use scissors to trim any pieces where needed. PARENTAL SUPERVISION is recommended.
- Identify each piece of the model by matching it with the parts drawing above.
- Assemble the model with standard white glue. It is a good idea to hold the pieces together with toothpicks until the glue is dry. Once the glue is dry, twist the toothpick and carefully pull it out.
- Use a small brush, flat stick, or your finger to spread glue evenly on the surface.
- Do not glue any of the pieces to the base until after Step 7.

Note: The missions can either be assembled on the cardboard sheet (included) or on a sheet of foam (not included).

- 9. Locate both #11 pieces. This is the roof of the main building. You will need to cut a 1/2" x 2" section off of the rear of the right roof piece so that it will follow the right wall of the main building. Apply glue to the roofline edges of #1 and #5. Put the #11 pieces into place as shown below.

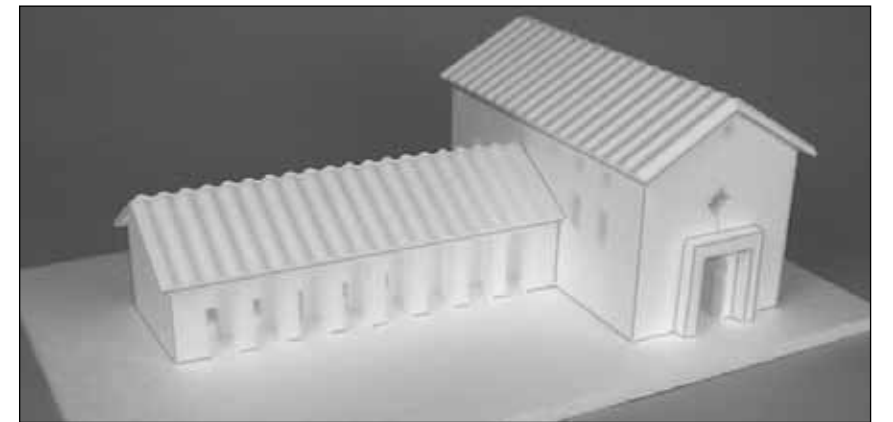
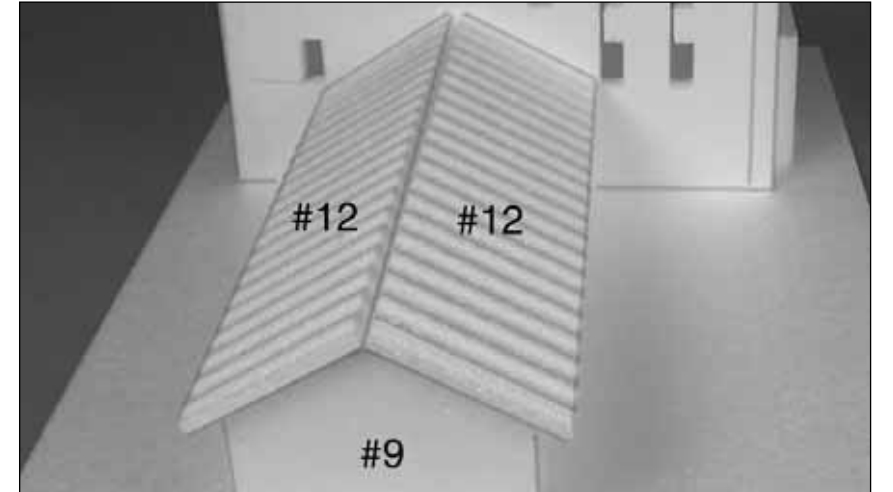
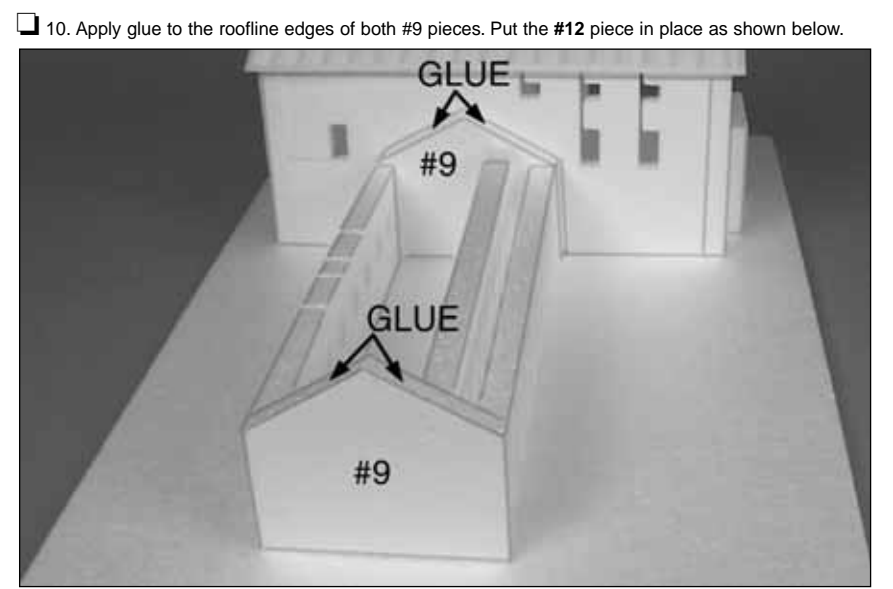
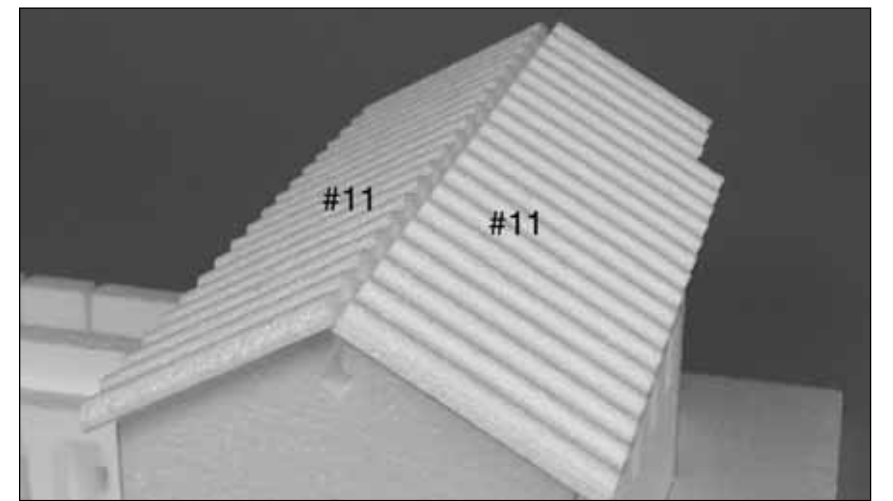
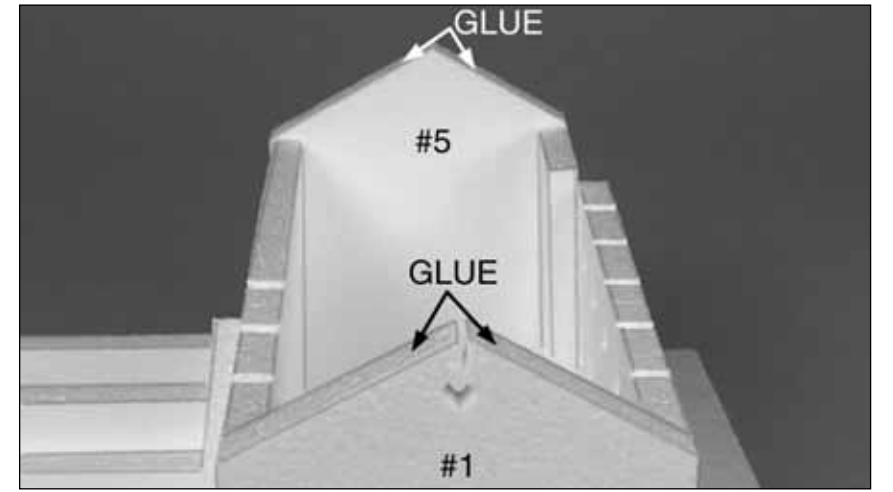
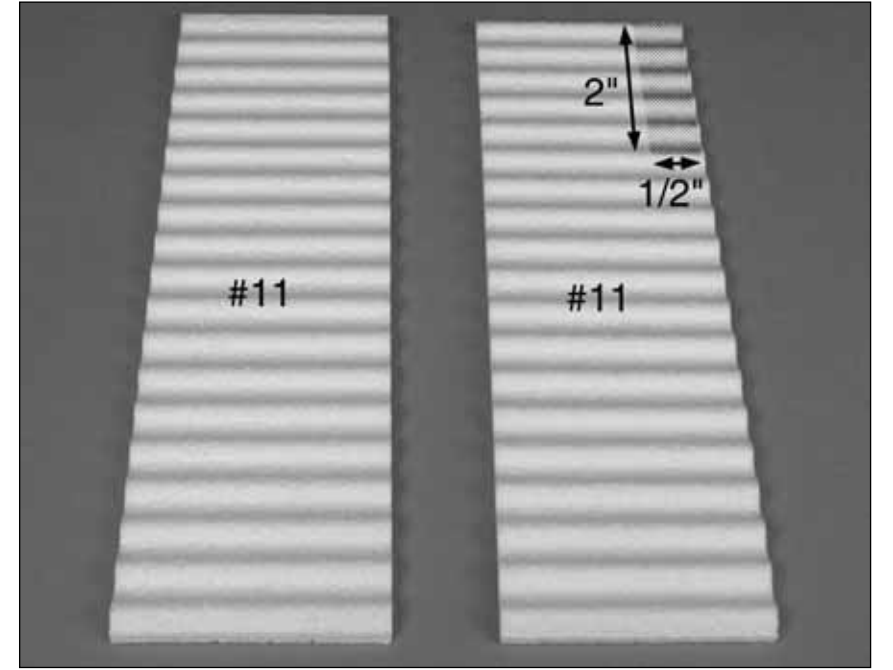

- 5. Apply glue to the backside of #6 and place it over the doorway as shown below.

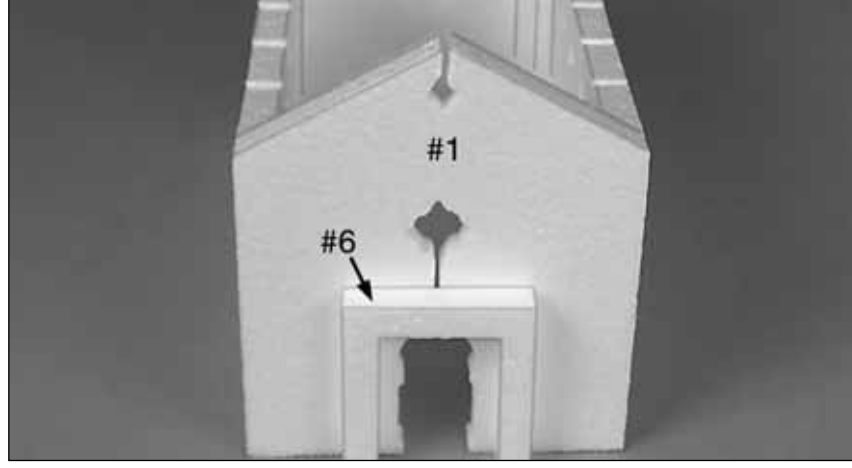

- 6. Apply glue to the front and rear edges of #7 and #8. Put both #9 pieces in place as shown below. Make sure all edges are even. This section will be called the "quarters."

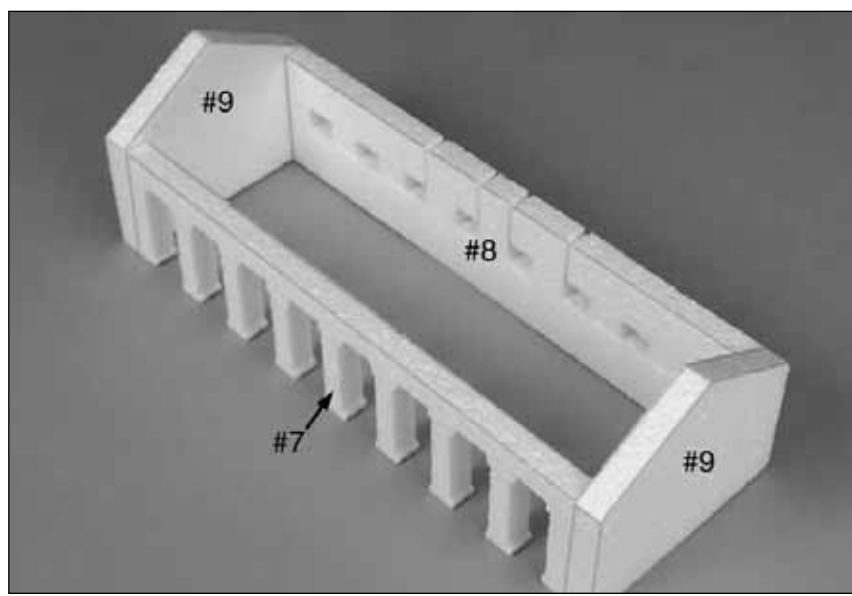
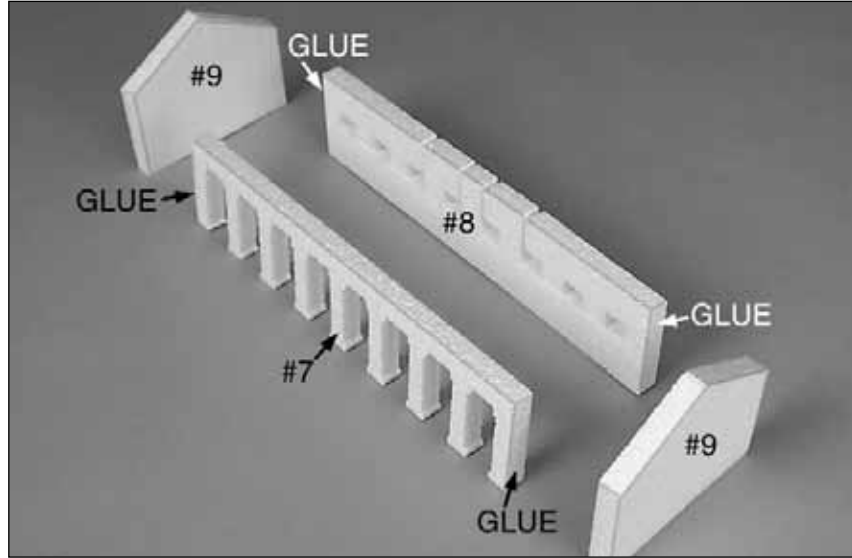

- 7. Apply glue to the front and rear edges of #10 and put it in place as shown below. There will be a 1/2" space between #7 and #10.

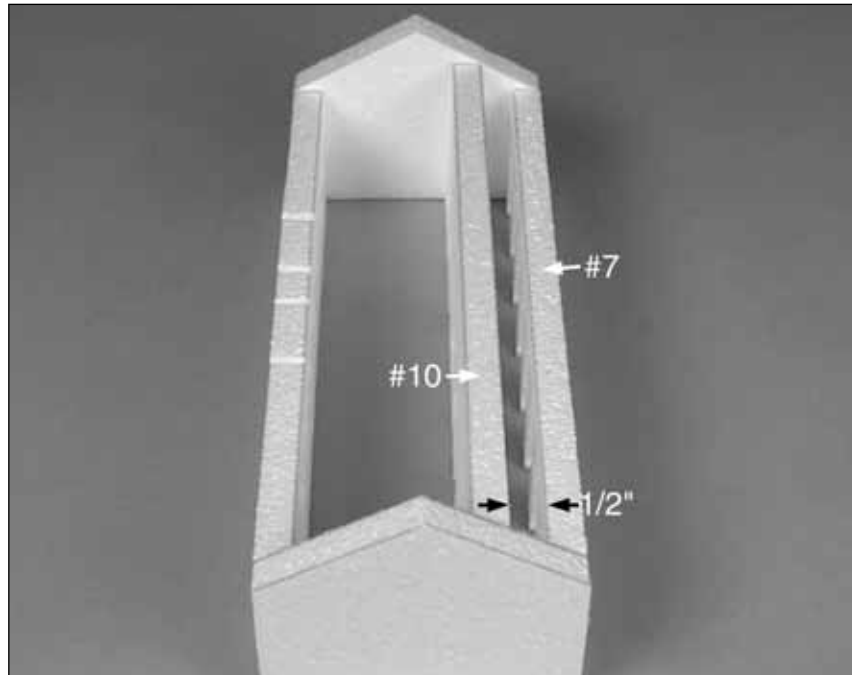
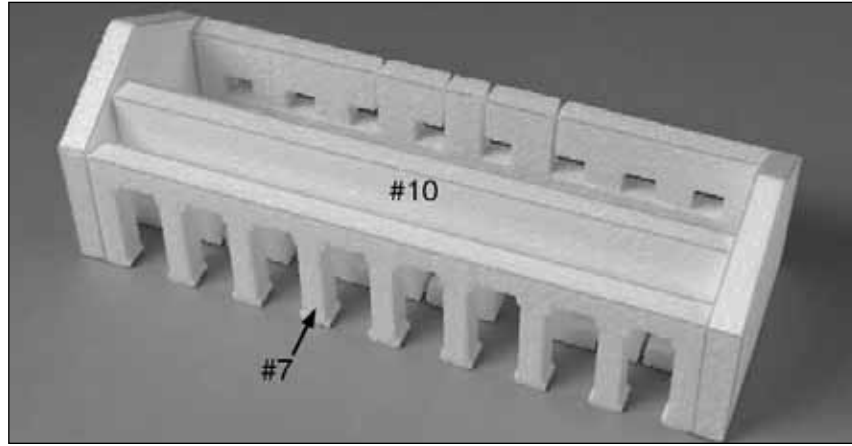

- 8. Now that the basic sections are complete, they can now be glued to the base. Glue the main building in place so that there is 2" from the front of the base to the front door. The right side of the main building should be 3" from the side of the base. This will leave you enough room to create scenery for your model. Glue the quarters in place so that the right side is up against the main building and the front wall is 6-1/4" from the front of the base.

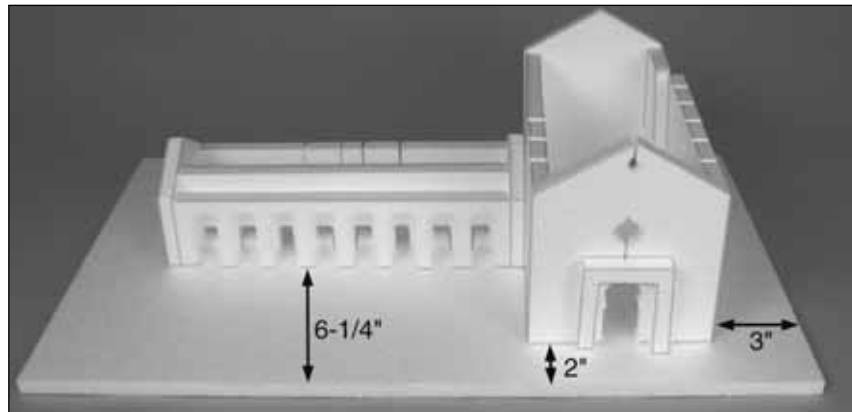

ASSEMBLY INSTRUCTIONS

- 1. Place the 24" x 15" base on a clean, flat surface.
- 2. Apply glue to the front and rear edges of piece #2 and the front edge of #3. Put #1 into place as shown below. Note the direction of all pieces. Make sure all other edges are even.

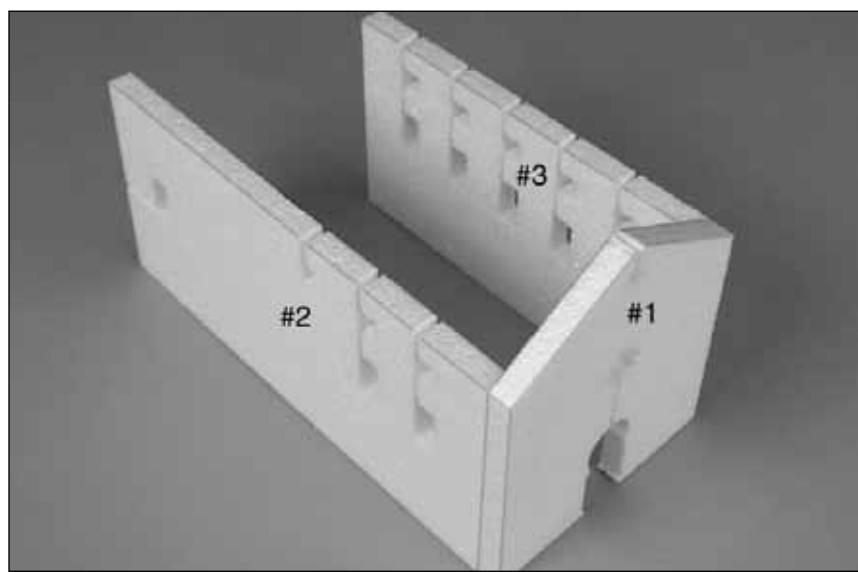
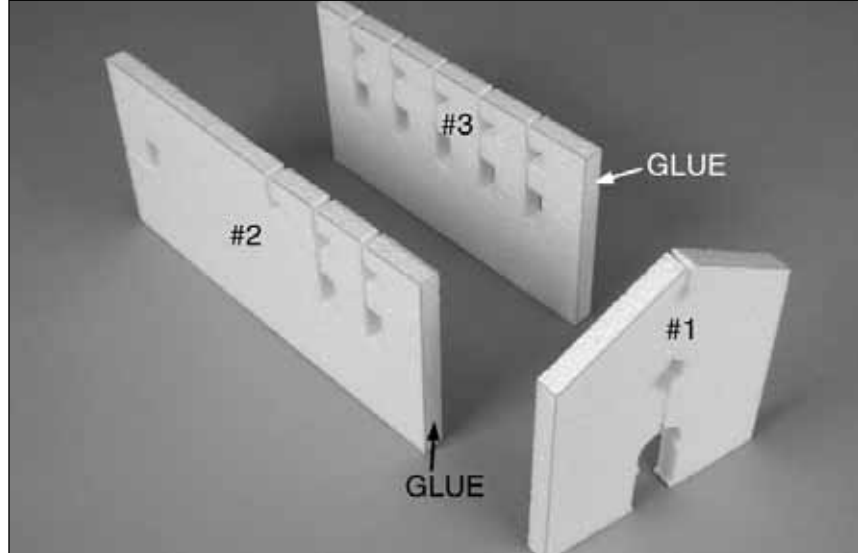

- 3. Apply glue to the rear edge of #4 and place it against #5 as shown below.

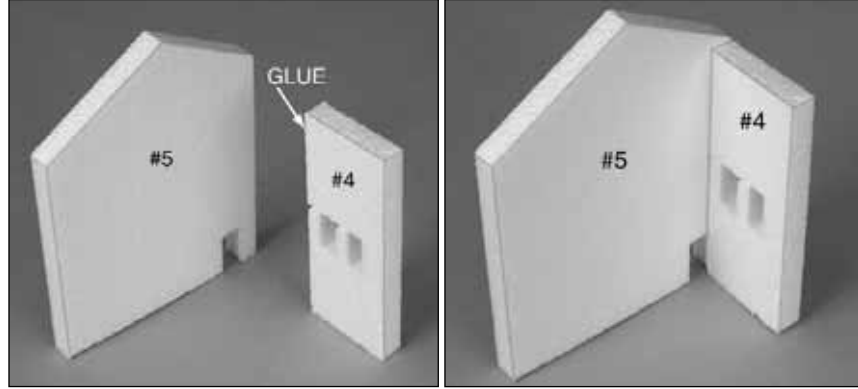

- 4. Glue the sections from steps 2 and 3 together as shown below. Pieces #3 and #4 will overlap by 1/4". Make sure the other edges are even. This section will be called the "main building."

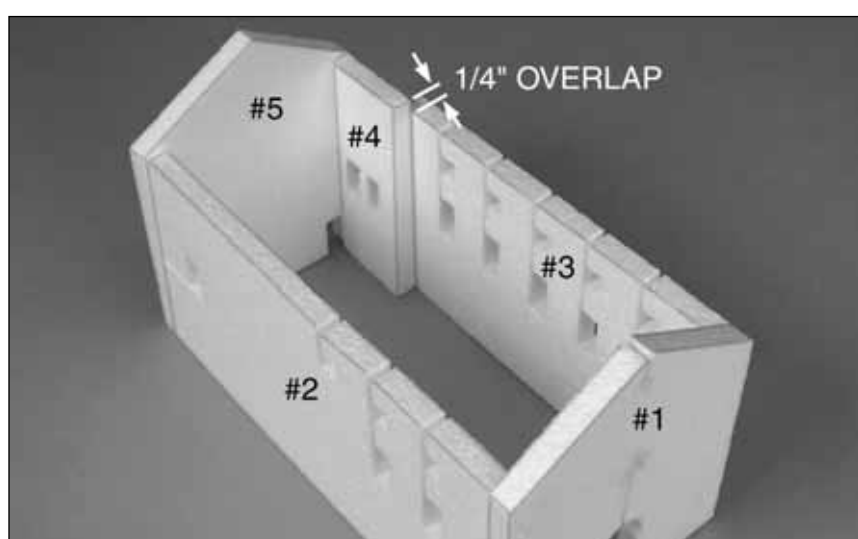
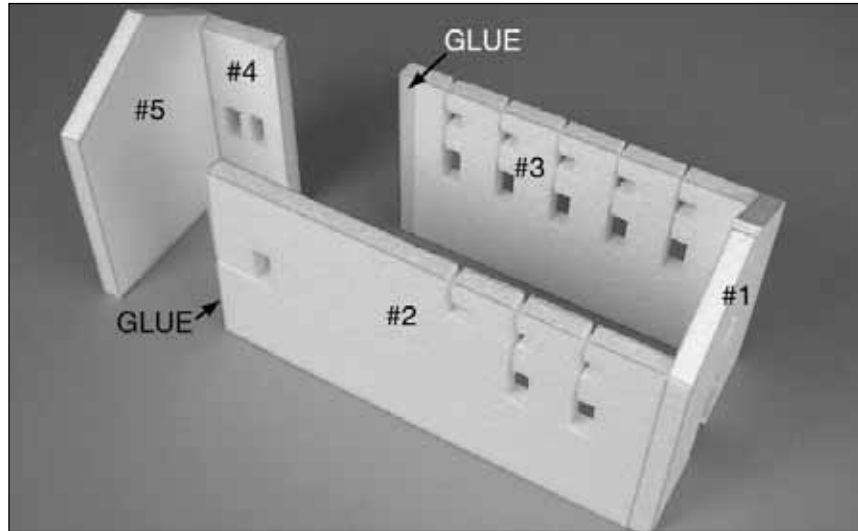

FINISHING

- When you paint your model, use only water-based paints.
- Check with your favorite hobby dealer for accessories such as grass, shrubbery, grave markers, action figures...etc. that will add realism to your model.