

# San Francisco de Asis Instructions

## Parts Drawing

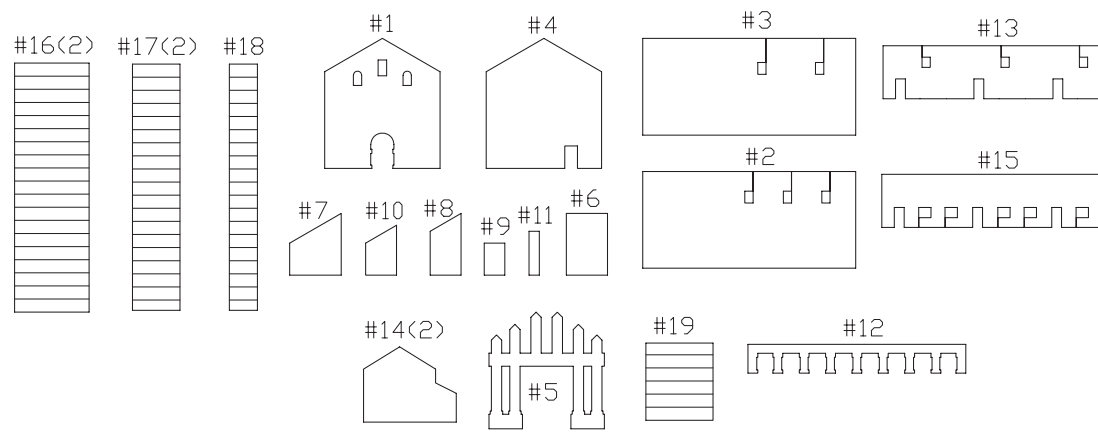

- Before starting assembly, read through each step of the instructions and carefully study each photo. As you put the model together, it is a good idea to "test" fit the pieces together before using any glue.
- Spread out newspaper across the table or desk that you are working on. This will help to protect your work surface.
- Use scissors to trim any pieces where needed. PARENTAL SUPERVISION is recommended.
- Identify each piece of the model by matching it with the parts drawing above.
- Assemble the model with standard white glue. It is a good idea to hold the pieces together with toothpicks until the glue is dry. Once the glue is dry, twist the toothpick and carefully pull it out.
- Use a small brush, flat stick, or your finger to spread glue evenly on the surface.
- Do not glue any of the pieces to the base until after Step 8.

Note: The missions can either be assembled on the cardboard sheet (included) or on a sheet of foam (not included).

7. Apply glue to the side edges of pieces #12 and #13. Put both #14 pieces into place as shown below, making sure the edges meet evenly. This section will be called the "quarters."

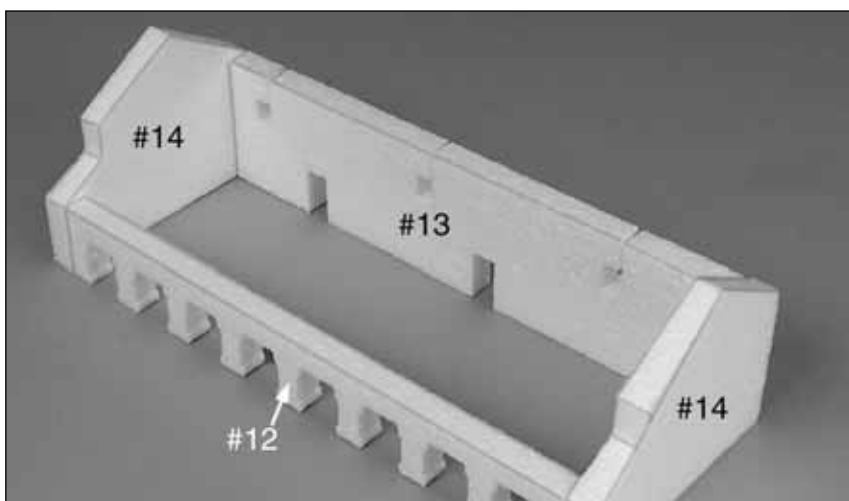
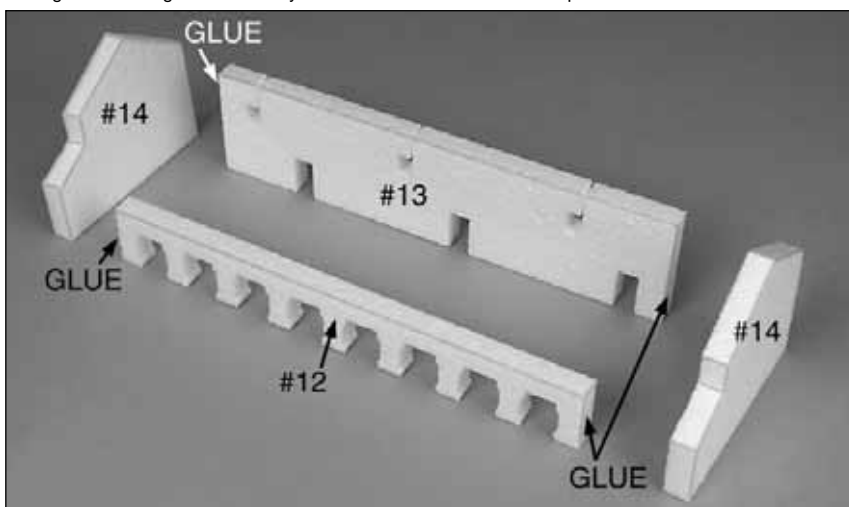

8. Apply glue to ends of #15. Glue in place as shown below (note the location of the #14 pieces).

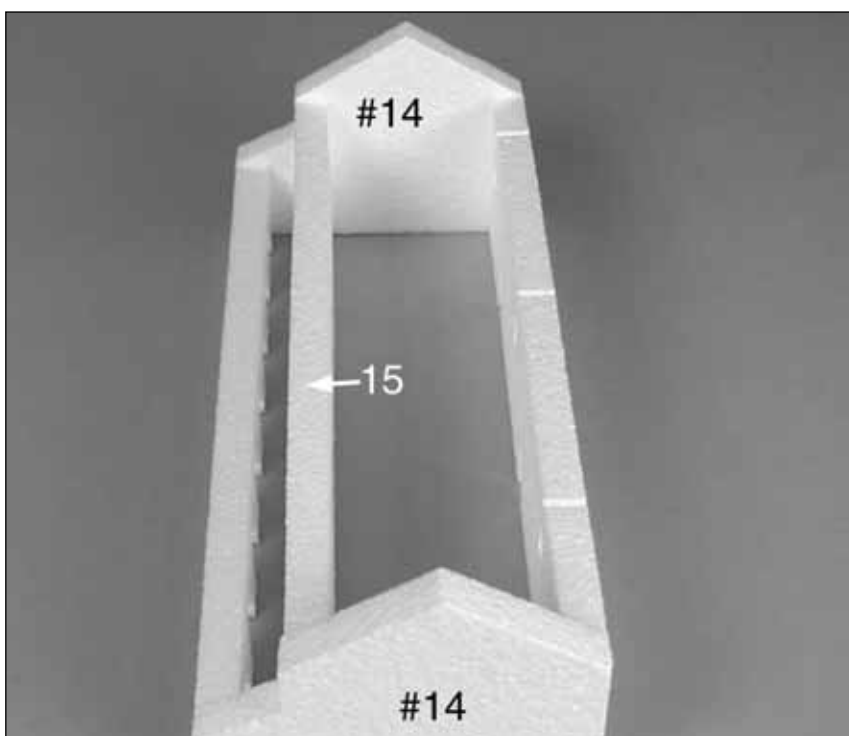
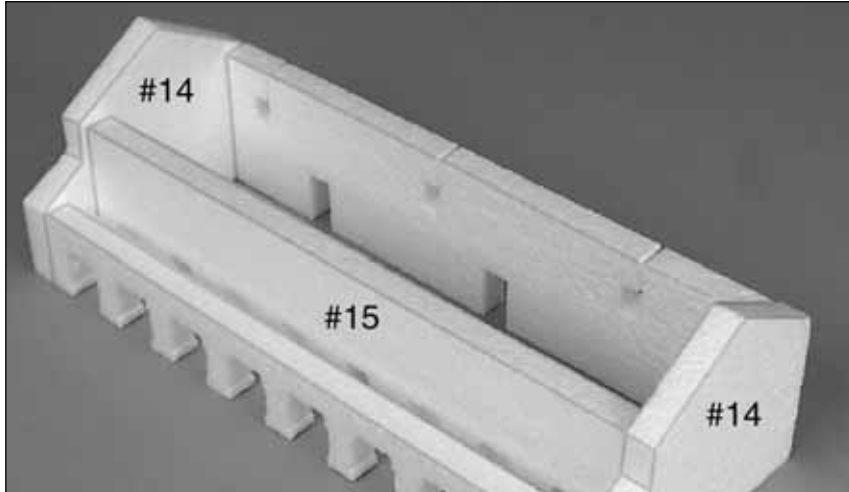

9. Now that the basic sections are complete, they can now be glued to the base. Glue the main building in place so that there is 2" from the front of the base to the front door. The left side of the main building should be 4" from the edge of the base. This will leave you enough room to create scenery for your model. Glue the quarters in place so that the left side is up against the main building and the front wall is 2-1/2" from the front of the base. Glue the side room in place so that the right side is up against the main building and the front wall is 4" from the front of the base.

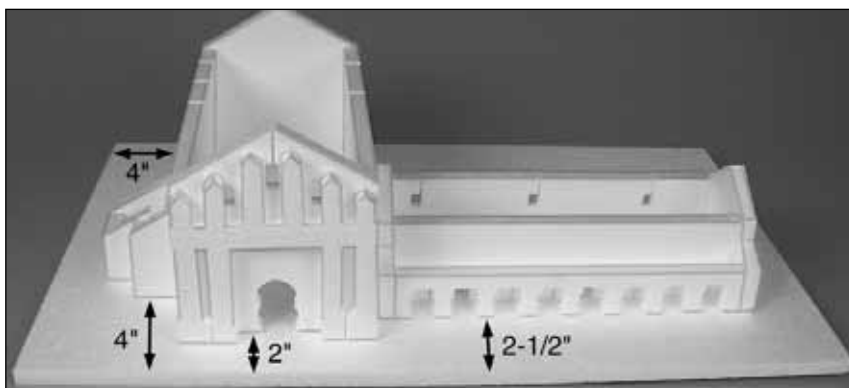

10. Apply glue to the roofline edges of #1 and #4. Put the #16 pieces into place as shown below.

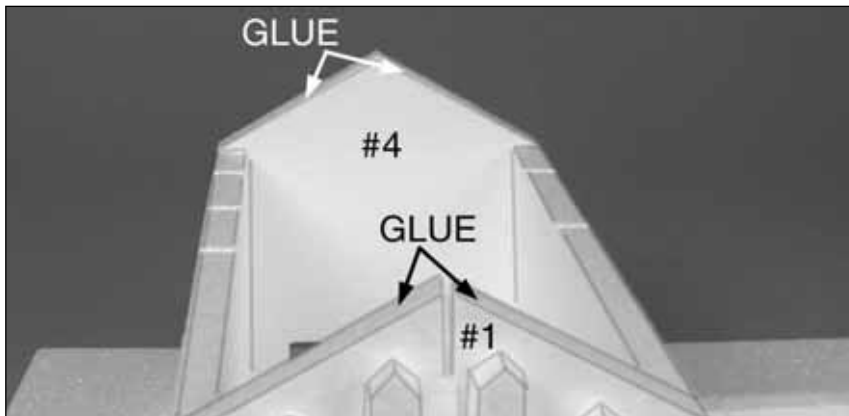

11. Apply glue to the roofline edges of both #14 pieces and put the #17 and #18 pieces in place as shown below.

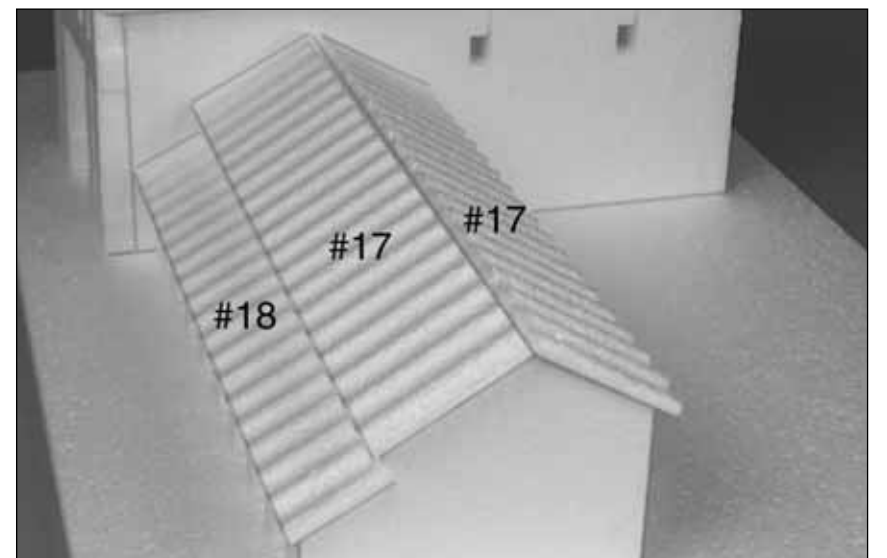
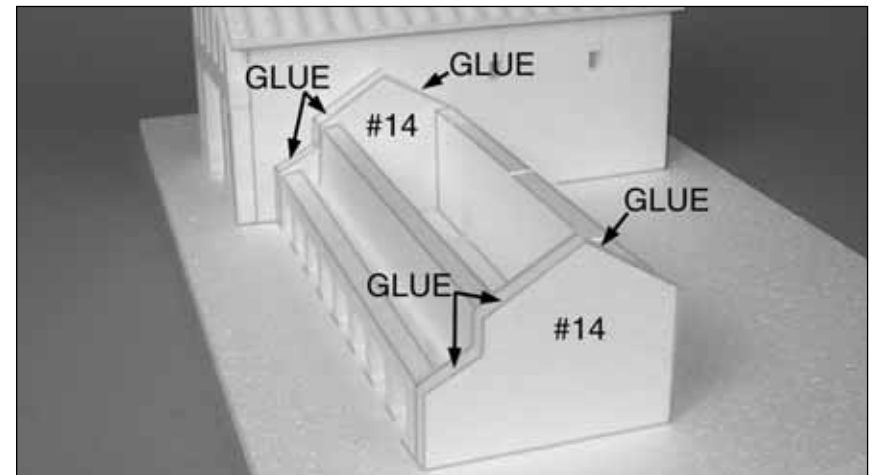

12. You will need to trim the #19 piece. Cut a 1" x 1" square out of the lower front as shown below (note direction). Apply glue to the roofline edges of #7, #8, and #10. Put the #19 piece in place as shown.

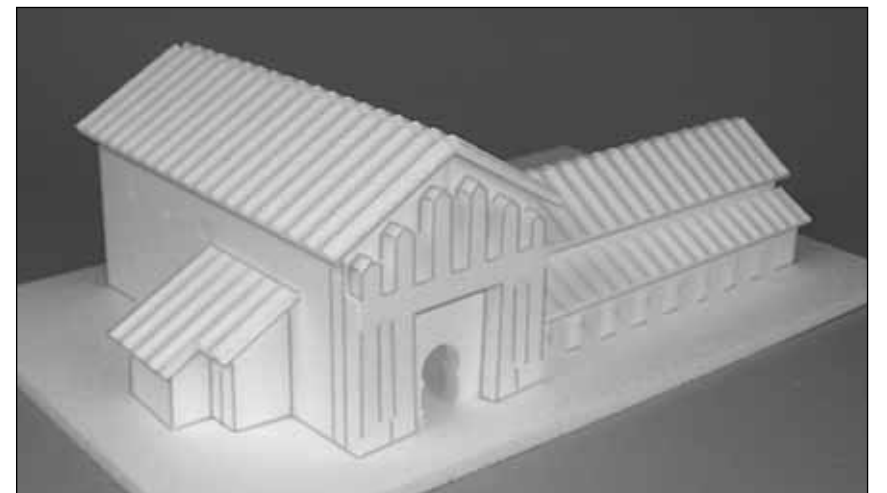
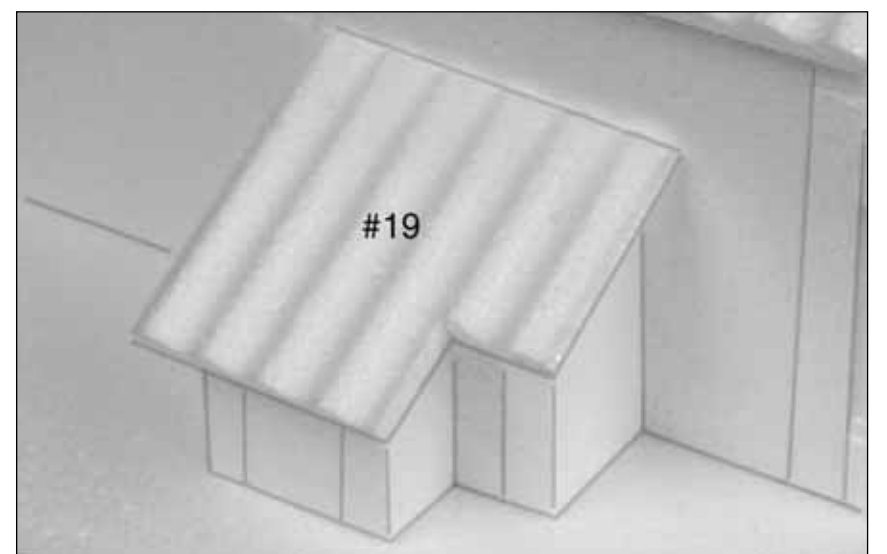
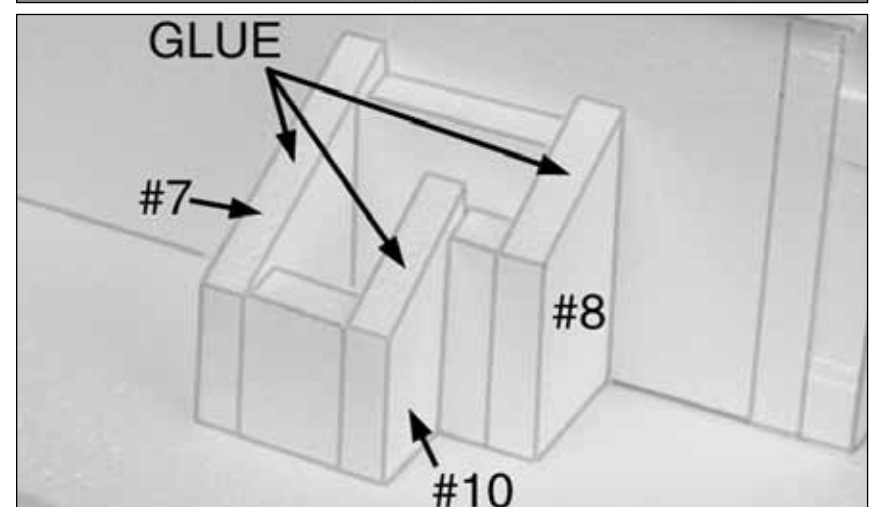
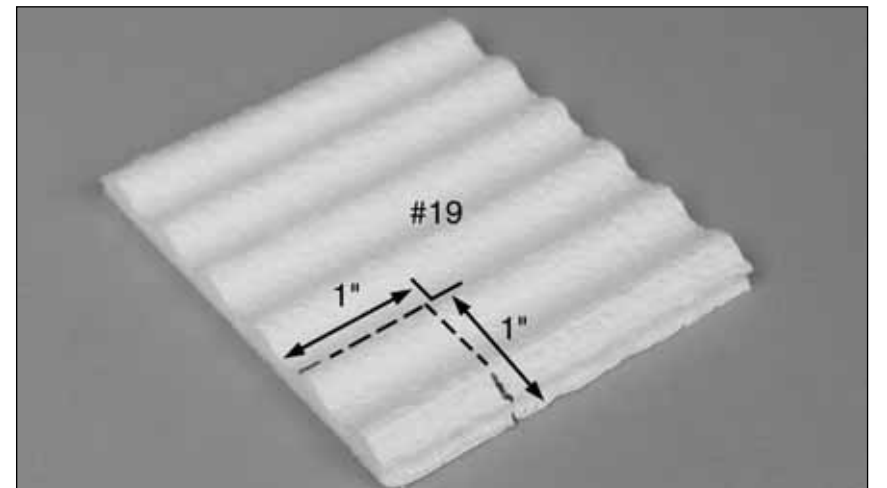

## ASSEMBLY INSTRUCTIONS

1. Place the 24" x 15" base on a clean, flat surface.
2. Apply glue to the front and rear edges of both #2 and #3 pieces. Put #1 and #4 into place as shown below. Note the direction of all pieces. Make sure all edges are even. This section will be called the "main building."

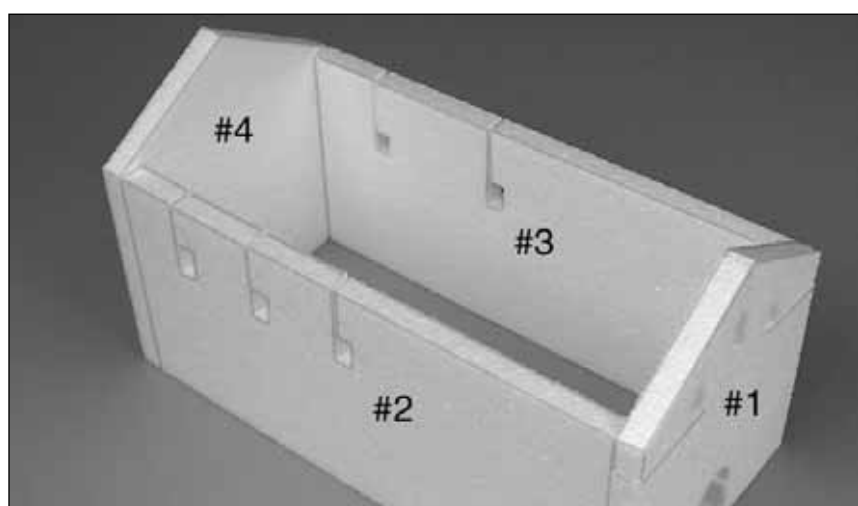
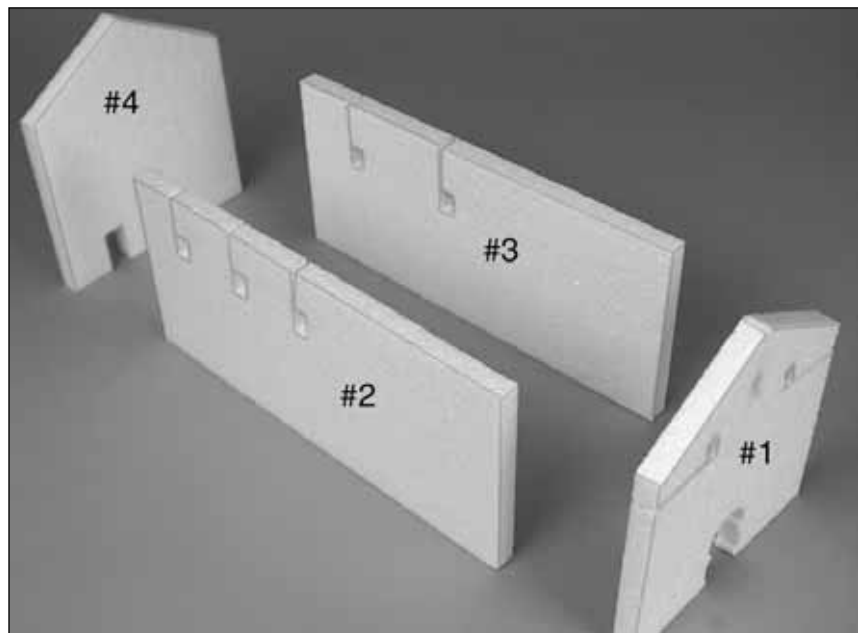

3. Glue #5 onto the front of the main building as shown below.

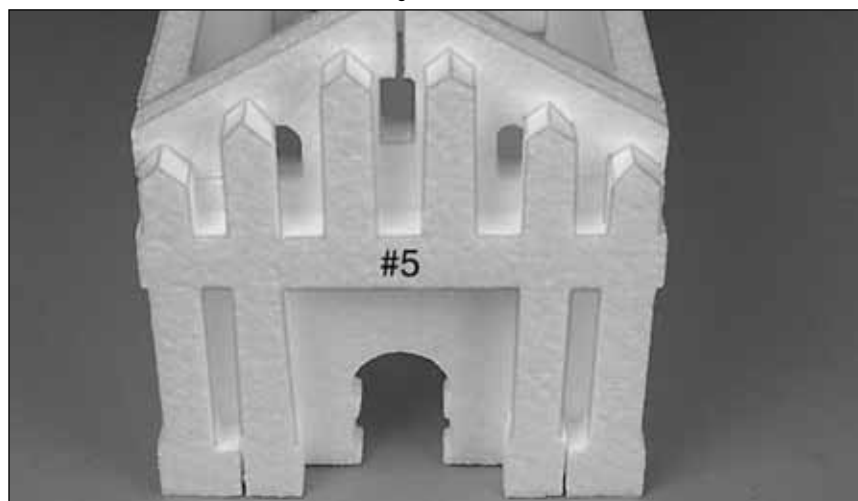

4. Apply glue to the side edges of #6 and put #7 and #8 into place as shown below. Make sure the edges are even.

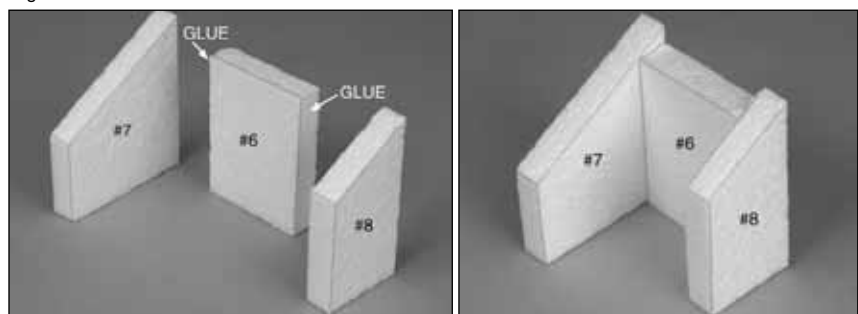

5. Glue pieces #9, #10, and #11 together as shown below. Make sure all edges are even.

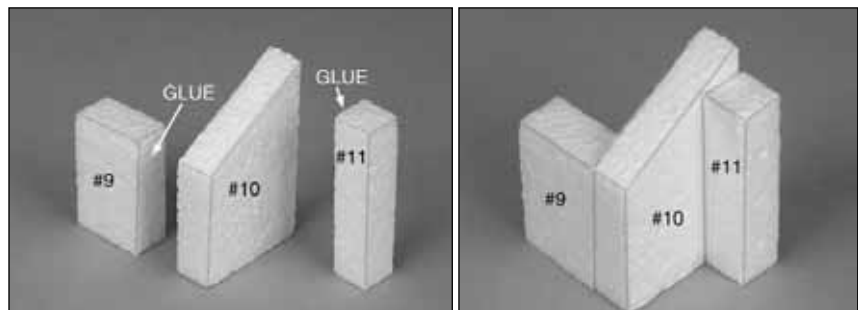

6. Glue the sections from steps 4 and 5 together as shown below. This section will be called the "side room."

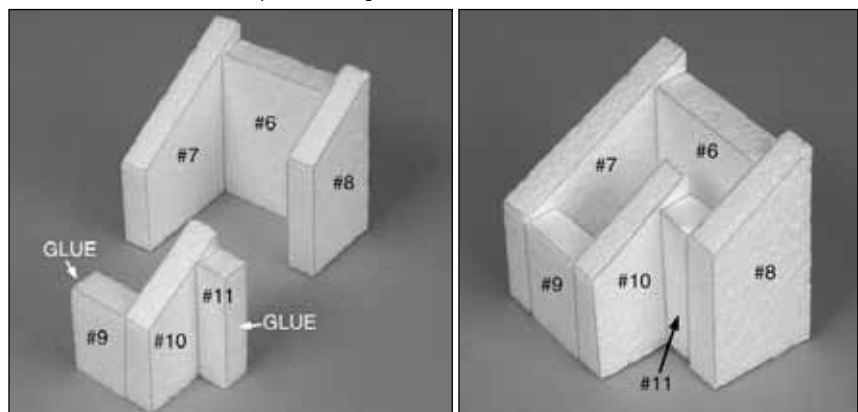

## FINISHING

- When you paint your model, use only water-based paints.
- Check with your favorite hobby dealer for accessories such as grass, shrubbery, grave markers, action figures...etc. that will add realism to your model.