

San Fernando Rey De Espana

Parts Drawing

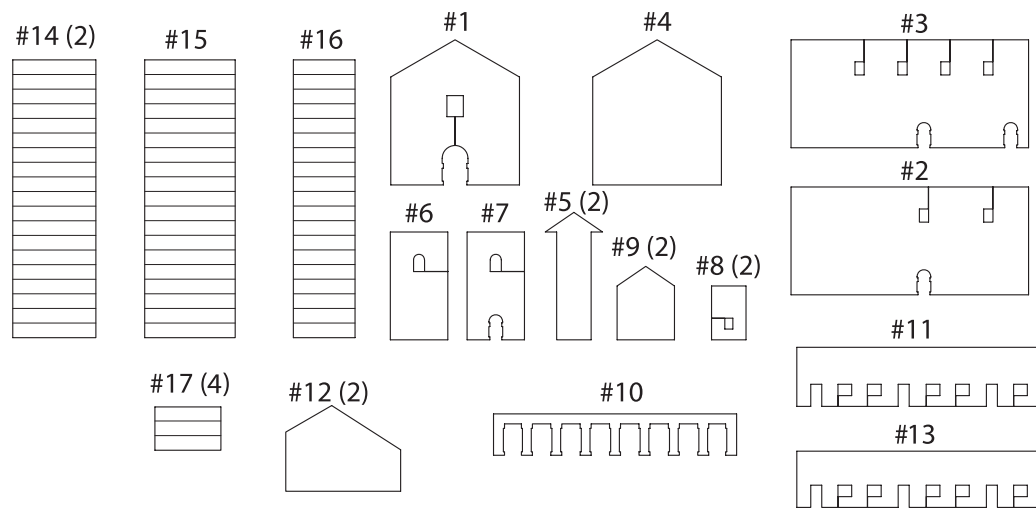

- Before starting assembly, read through each step of the instructions and carefully study each photo. As you put the model together, it is a good idea to "test" fit the pieces together before using any glue.
- Spread out newspaper across the table or desk that you are working on. This will help to protect your work surface.
- Use scissors to trim any pieces where needed. PARENTAL SUPERVISION is recommended.
- Identify each piece of the model by matching it with the parts drawing above.
- Assemble the model with standard white glue. It is a good idea to hold the pieces together with toothpicks until the glue is dry. Once the glue is dry, twist the toothpick and carefully pull it out.
- Use a small brush, flat stick, or your finger to spread glue evenly on the surface.
- Do not glue any of the pieces to the base until after Step 6.

Note: The missions can either be assembled on the cardboard sheet (included) or on a sheet of foam (not included).

- 6. Apply glue to the side edges of piece #13. Put it in place as shown, so that there is a 1/2" space between #13 and #10.

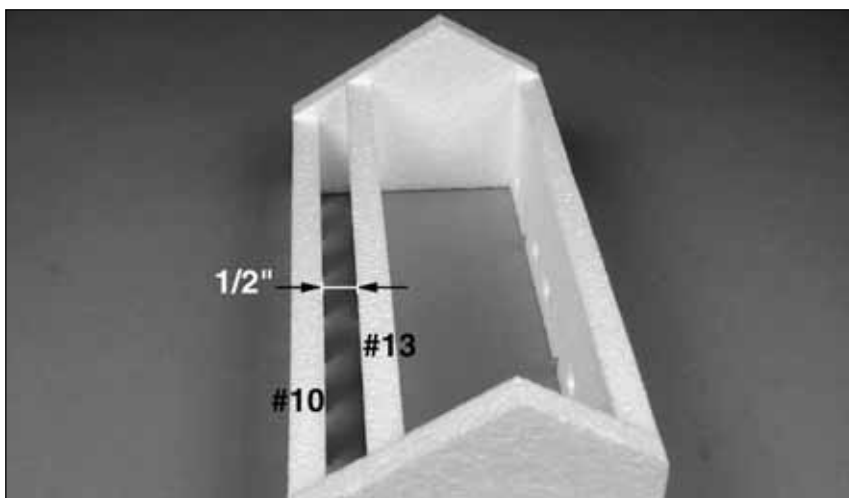
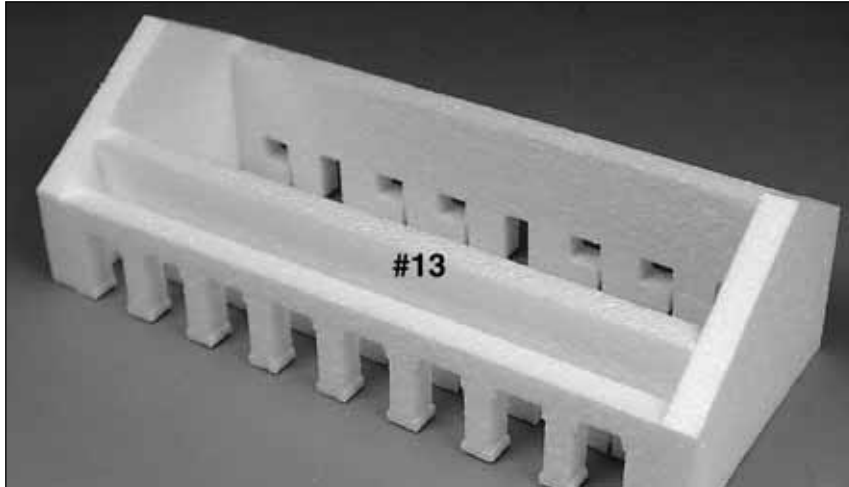

- 7. Now that the basic sections are complete, they can now be glued to the base. Glue the main building in place so that there is 3" from the front of the base to the front door. The left side of the main building should be 3-1/2" from the edge of the base. This will leave you enough room to create scenery for your model.

Glue the bell tower in place so that the left side is up against the main building. The front walls of both sections should meet evenly, as shown.

Glue the quarters in place so that the left side is up against the bell tower. The rear walls of both sections should meet evenly, as shown.

Glue the side room in place so that the right side is up against the main building and the front wall is 4" from the front of the base, as shown.

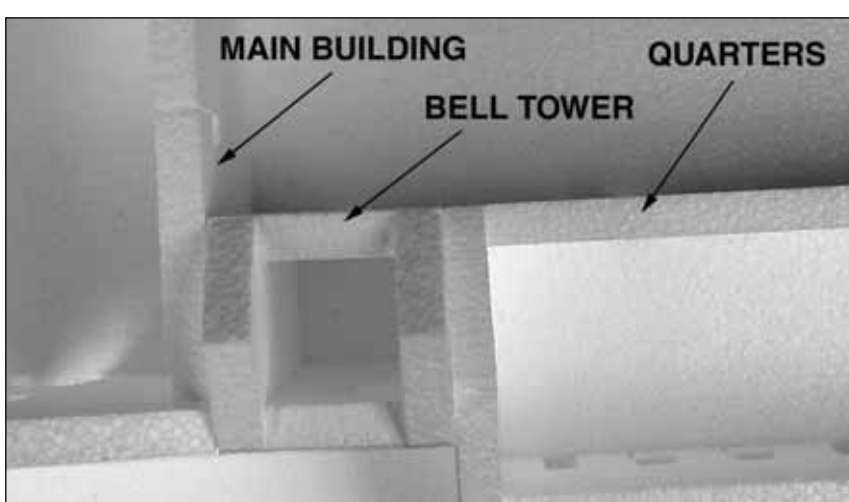
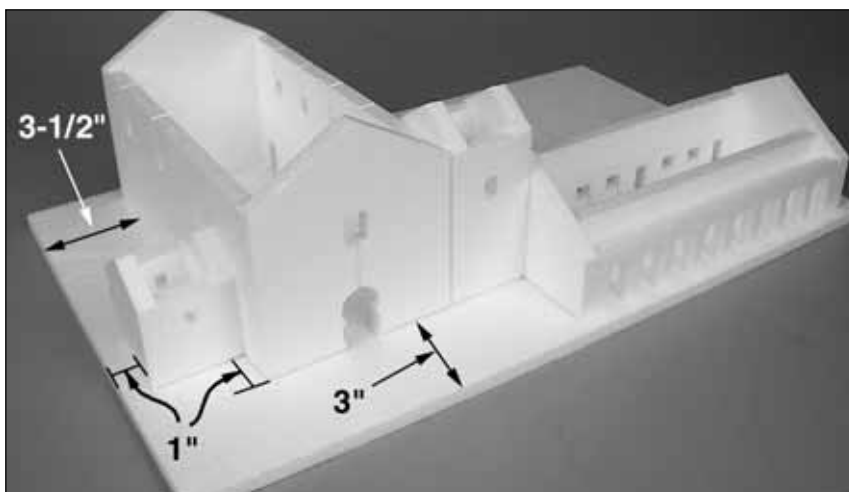

- 8. Locate both pieces of #14 roof material. This is the roof of the main building. You will need to cut a small portion off of the right roof piece so that it will fit tightly against the bell tower. Using scissors, cut away 5/8" over and 3" from the front edge of the roof as shown.

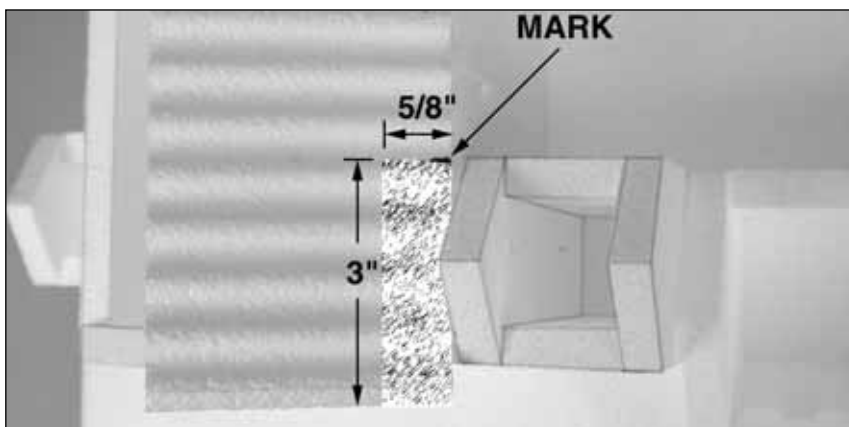

Apply glue to the roofline edges of #1 and #4. Put the #14 roof pieces into place as shown.

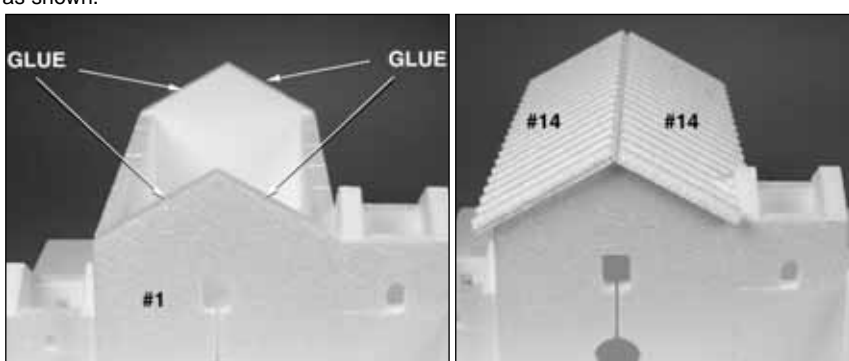

- 9. Apply glue to the roofline edges of both #12 pieces. Put the #15 and #16 roof pieces in place as shown.

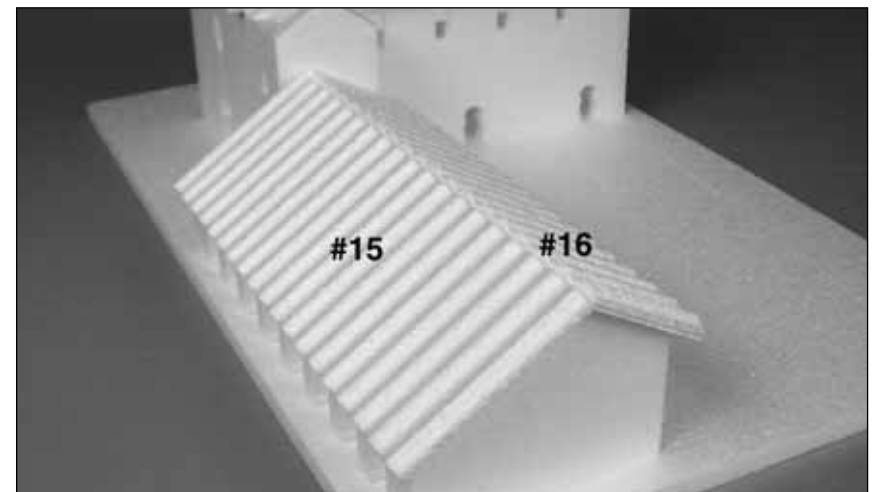
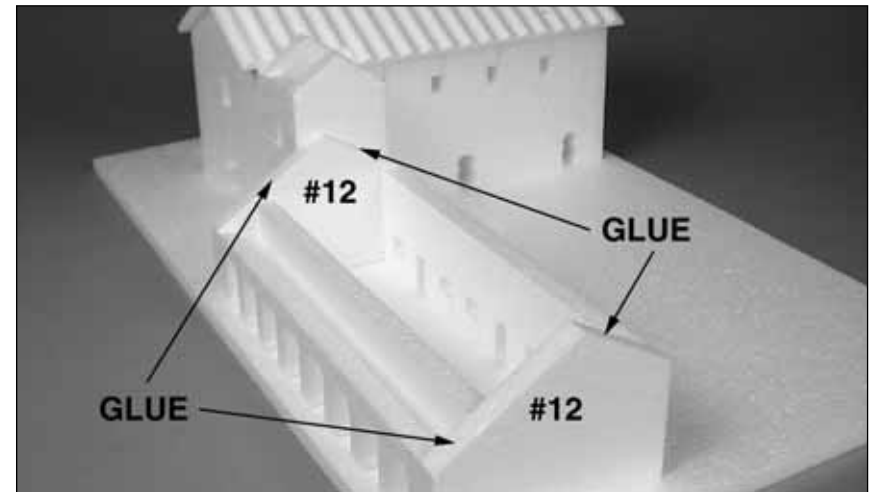

- 10. Apply glue to the roofline edges of both #9 pieces. Put two of the #17 roof pieces in place as shown.

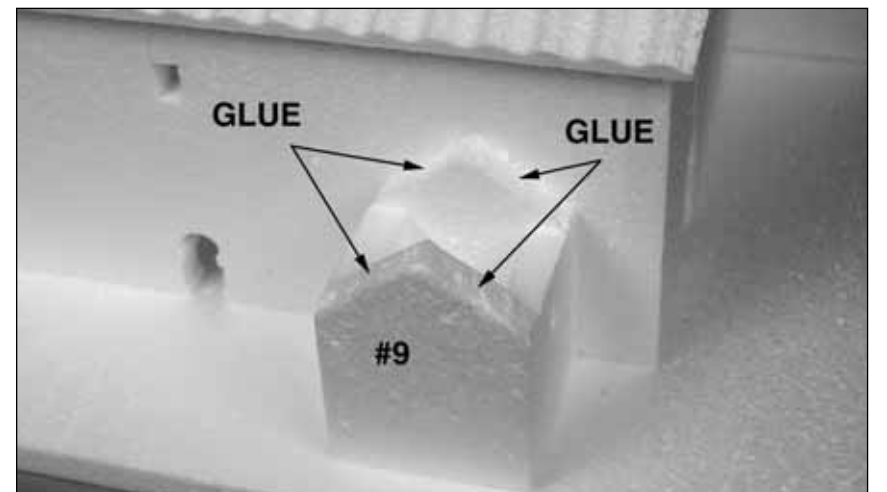

- 11. Apply glue to the roofline edges of both #5 pieces. Put the remaining two #17 roof pieces in place as shown. You will need to trim 1/4" off of the rear piece so that it will fit properly.

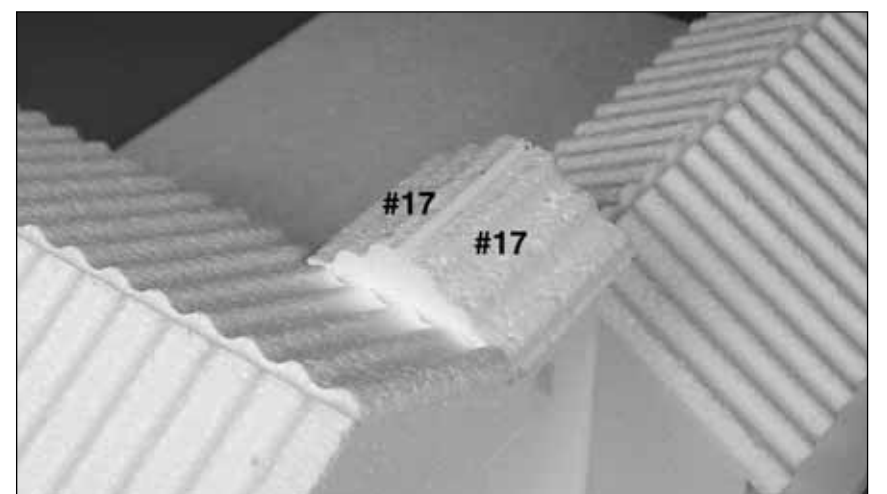
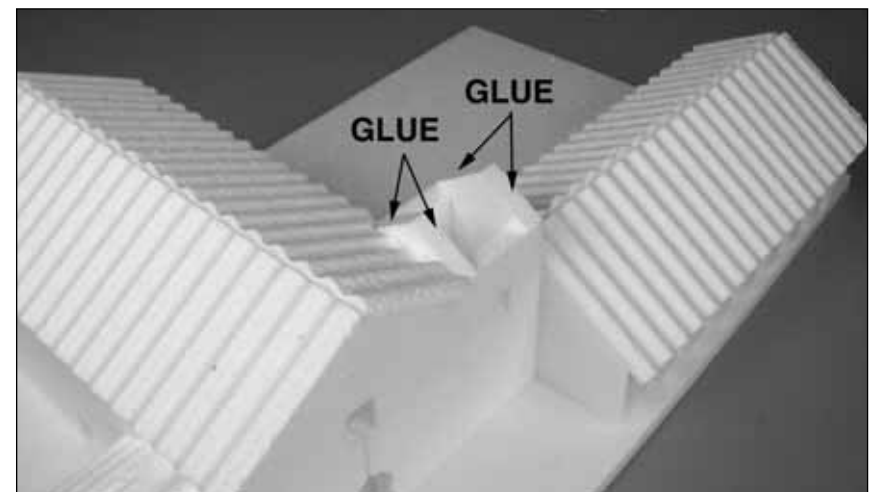

ASSEMBLY INSTRUCTIONS

- 1. Place the 24"x15" base on a clean, flat surface.

- 2. Apply glue to the front and rear edges of the #2 and #3 pieces. Put #1 and #4 into place as shown. Make sure all other edges are even. This section will be called the "main building".

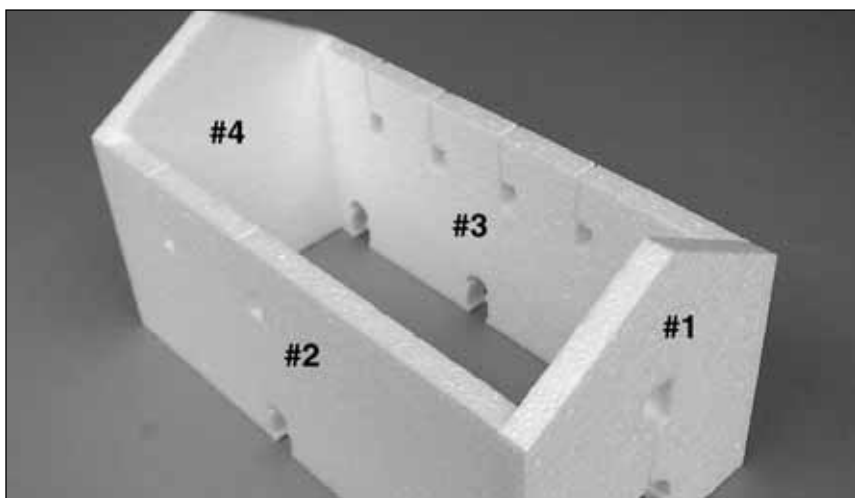
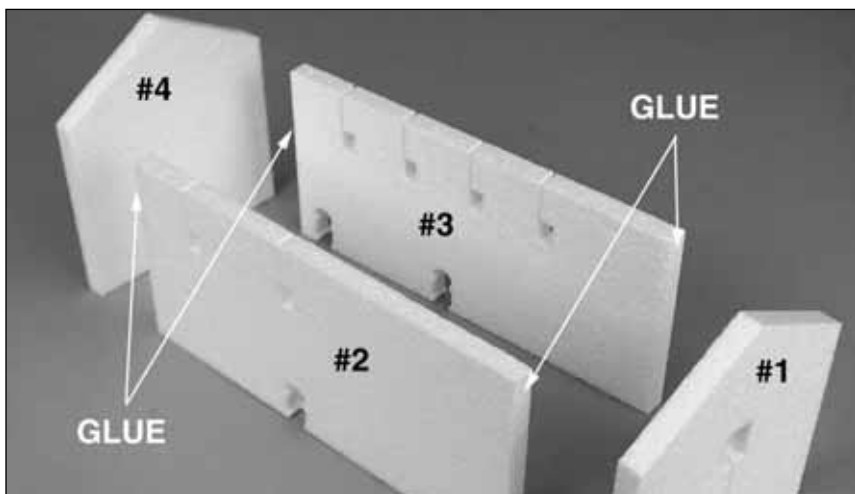

- 3. Apply glue to the front and rear edges of both #5 pieces. Put #6 and #7 in place as shown, making sure the edges meet evenly. This section will be called the "bell tower".

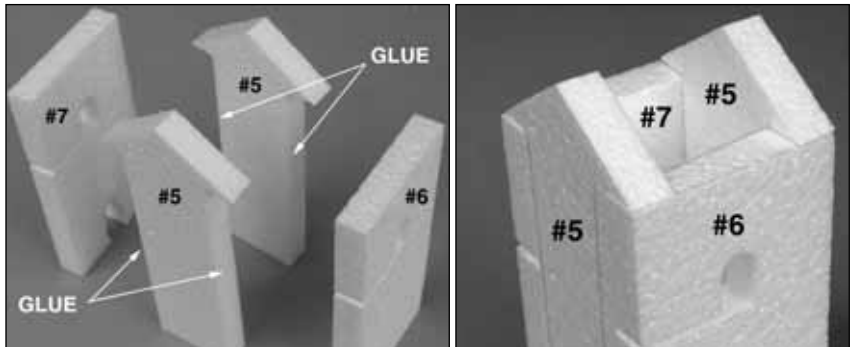

- 4. Apply glue to the side edges of both #8 pieces. Put both #9 pieces in place as shown, making sure the edges meet evenly. This section will be called the "side room".

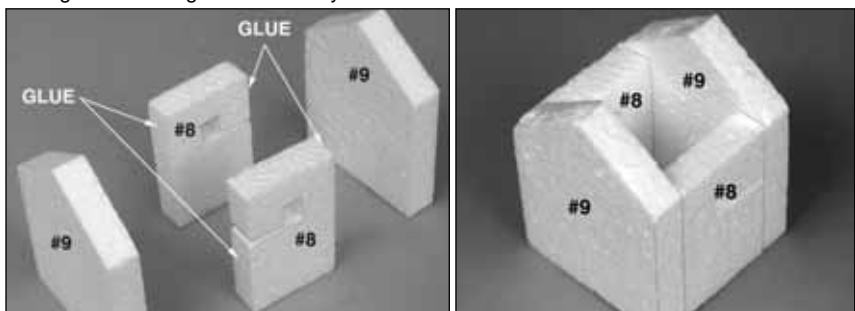

- 5. Apply glue to the side edges of pieces #10 and #11. Put both #12 pieces into place as shown, making sure the edges meet evenly. This section will be called the "quarters". Note: Pieces #11 and #13 are not the same; #11 is 1/8" taller.

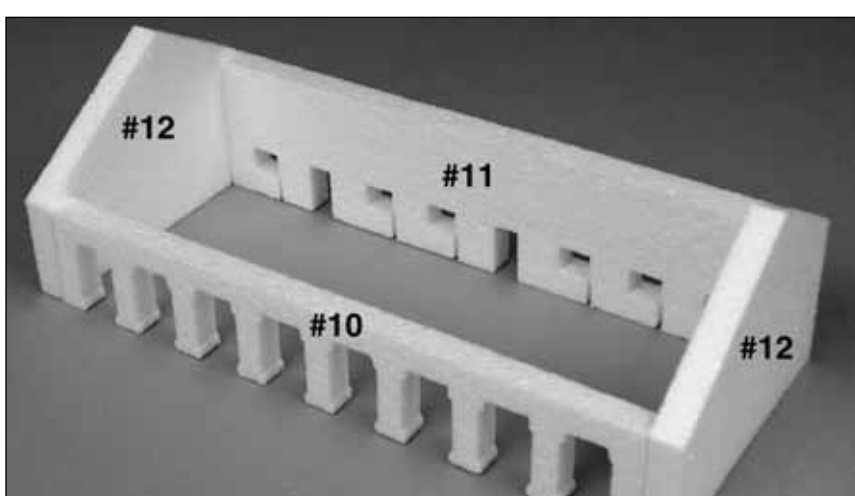
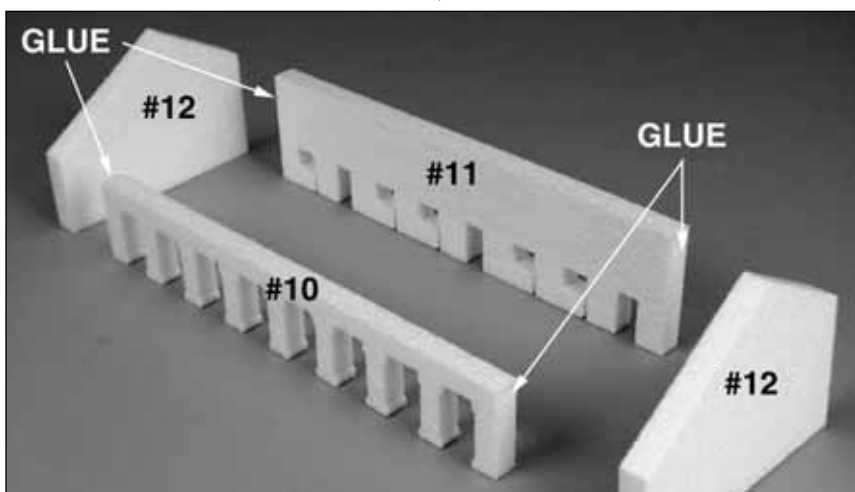

FINISHING

When you paint your model, use only water-based paints.



Check with your favorite hobby dealer for accessories such as grass, shrubbery, grave markers, figures...etc. that will add realism to your model.