

San Buenaventura Instructions

Parts Drawing

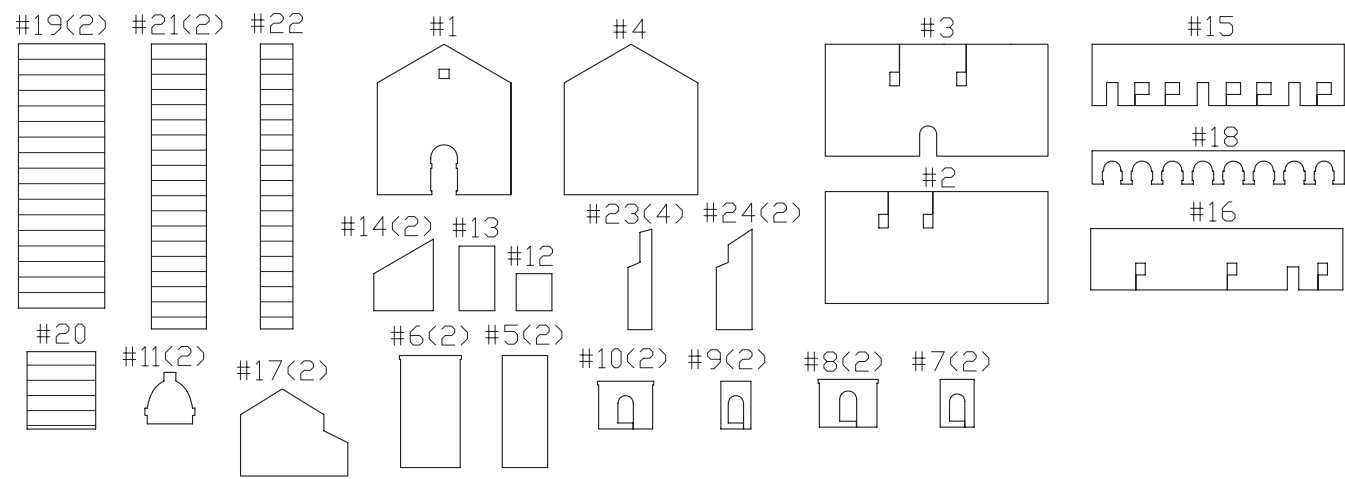

- Before starting assembly, read through each step of the instructions and carefully study each photo. As you put the model together, it is a good idea to "test" fit the pieces together before using any glue.
- Spread out newspaper across the table or desk that you are working on. This will help to protect your work surface.
- Use scissors to trim any pieces where needed. PARENTAL SUPERVISION is recommended.
- Identify each piece of the model by matching it with the parts drawing above.
- Assemble the model with standard white glue. It is a good idea to hold the pieces together with toothpicks until the glue is dry. Once the glue is dry, twist the toothpick and carefully pull it out.
- Use a small brush, flat stick, or your finger to spread glue evenly on the surface.
- Do not glue any of the pieces to the base until after Step 9.

Note: The missions can either be assembled on the cardboard sheet (included) or on a sheet of foam (not included).

7. Apply glue to the side edges of #12 and #13. Put both #14 pieces in place as shown below. Make sure the edges meet evenly. This section will be called the "side room."

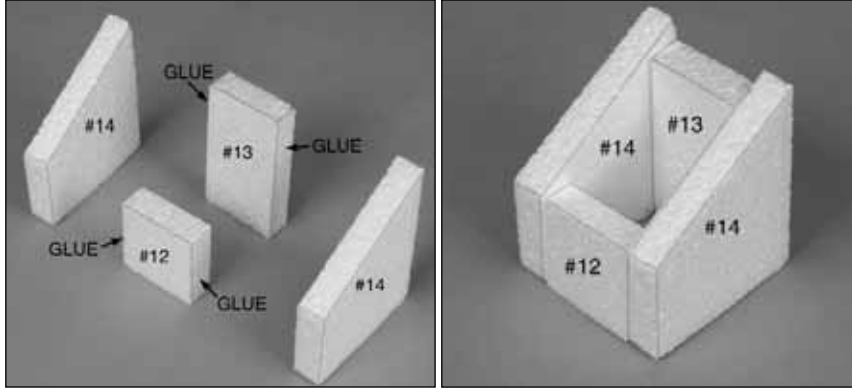

8. Apply glue to the side edges of #15 and #16. Put both #17 pieces in place as shown below. Make sure the edges meet evenly. This section will be called the "quarters."

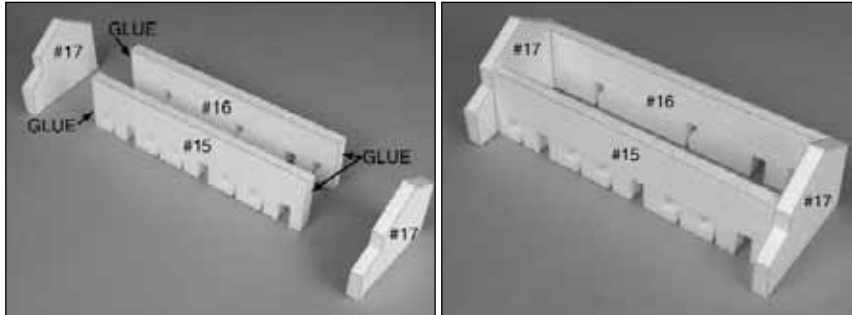

9. Apply glue to the side edges of #18 and place it between both #17 pieces as shown below.

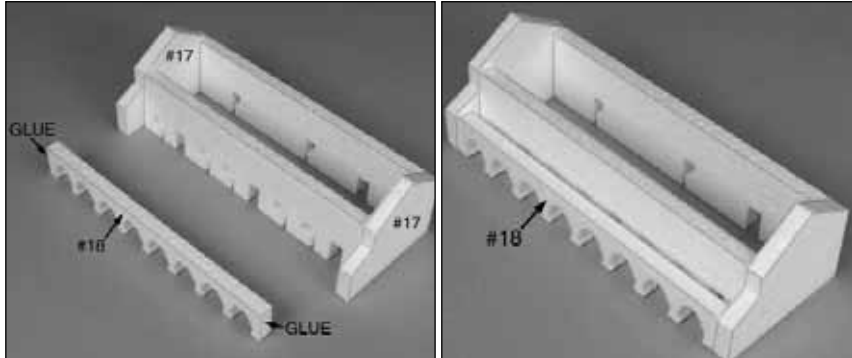

10. Now that the basic sections are complete, they can now be glued to the base. Glue the main building in place so that there is 2" from the front of the base to the front door. The left side of the main building should be 3-1/2" from the edge of the base. Glue the bell tower in place so that the left side is up against the main building and the front wall is 1" from the front edge of the base. Glue the side room in place so that it is up against the main building and there is 9" from the front wall to the front edge of the base. Glue the quarters in place so that there is a 1-1/2" gap between the left wall and the main building. There should be 9-1/2" between the front wall of the quarters and the front edge of the base. This will leave you enough room to create scenery for your model.

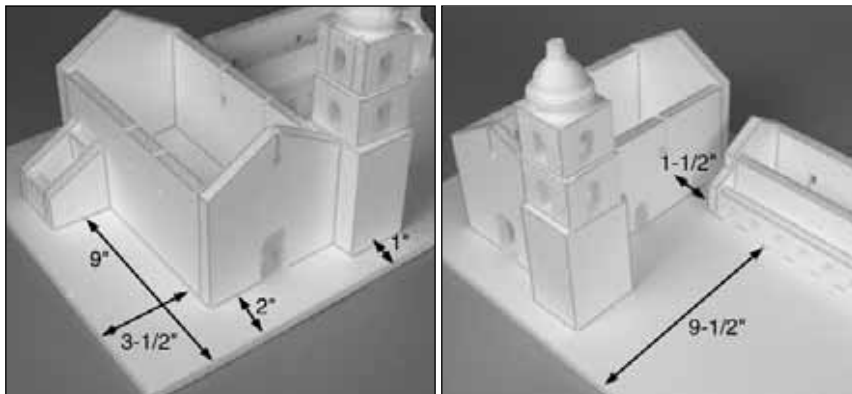

11. Locate both #19 pieces. This is the roof of the main building. You will need to cut a small portion off of the right roof piece so that it will fit tightly against the bell tower. Make a mark where the bell tower meets the roof. Using scissors, cut away about 1/2" in and 2-1/4" down as shown. Apply glue to the roofline edges of #1 and #4. Put the #19 roof pieces in place as shown below.

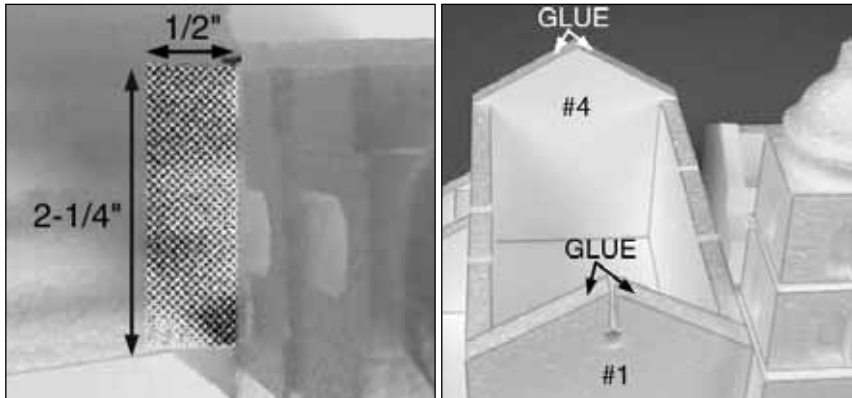

12. Apply glue to the roofline edges of both #14 pieces and put the #20 pieces in place as shown below.

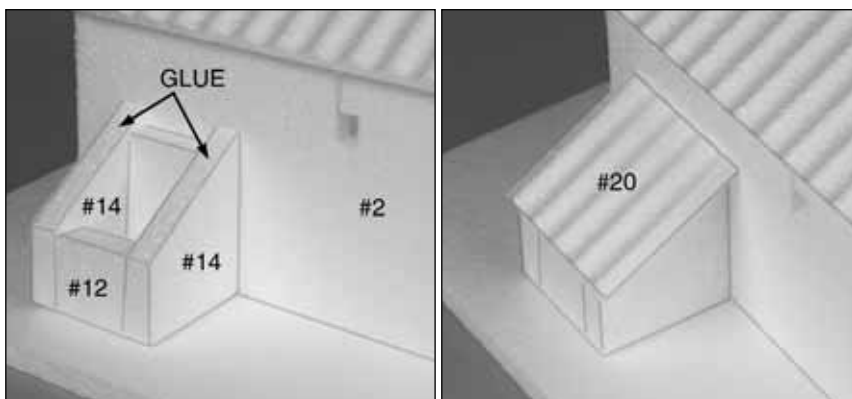

13. Apply glue to the roofline edges of both #17 pieces and put the #21 and #22 pieces in place as shown in the two photos that follow.

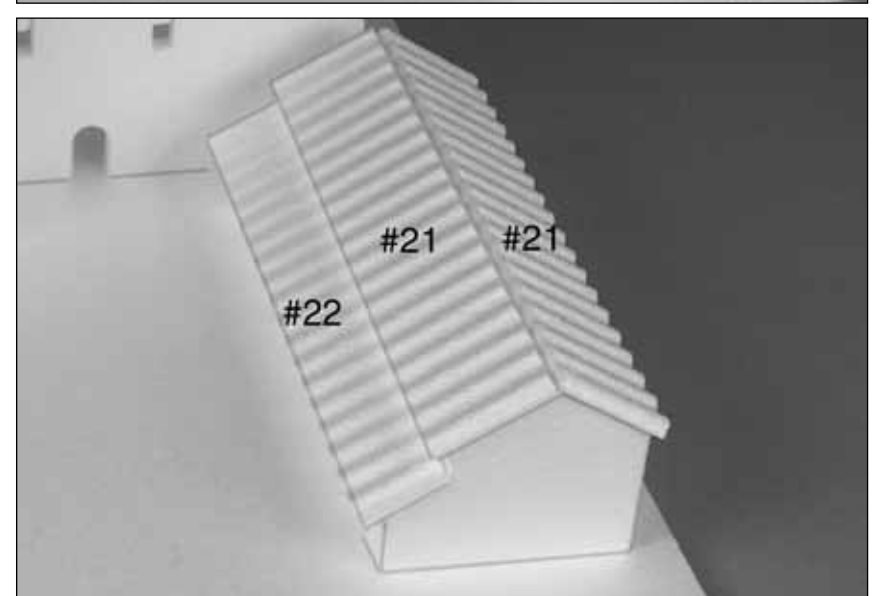
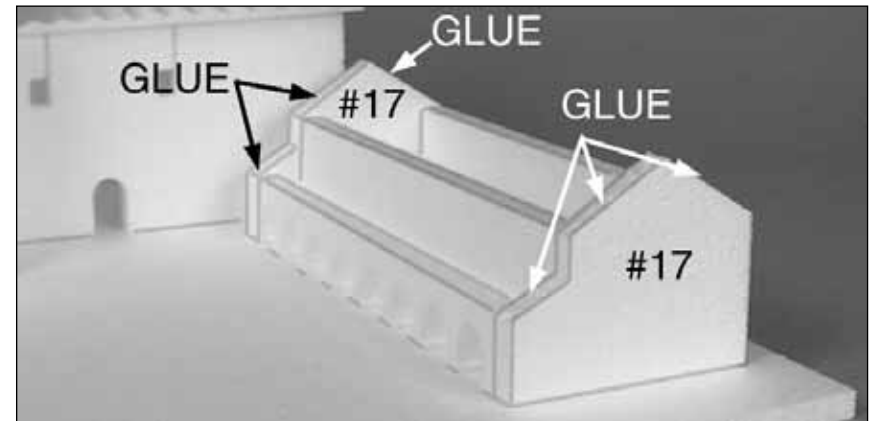

14. Glue the two #24 pieces together and then glue them into place up against #1 as shown below.

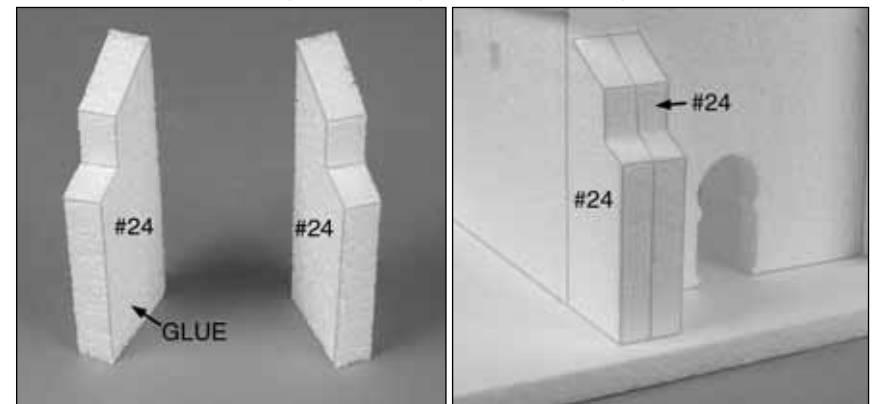

15. Locate the four #23 pieces. Glue three of them to the left side (#2) as shown below. There should be 1-1/2" between them. Glue the remaining #23 piece to the backside of the main building as shown.

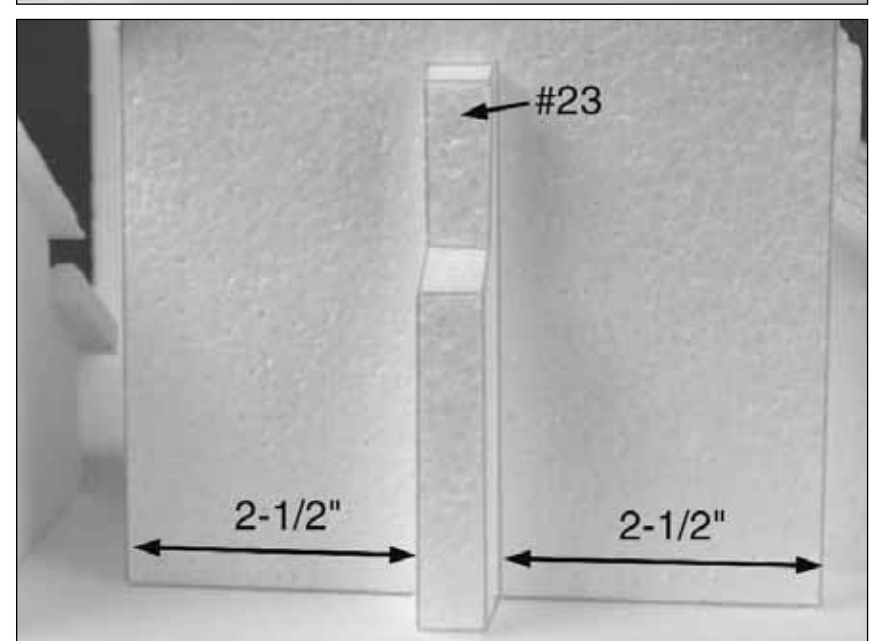
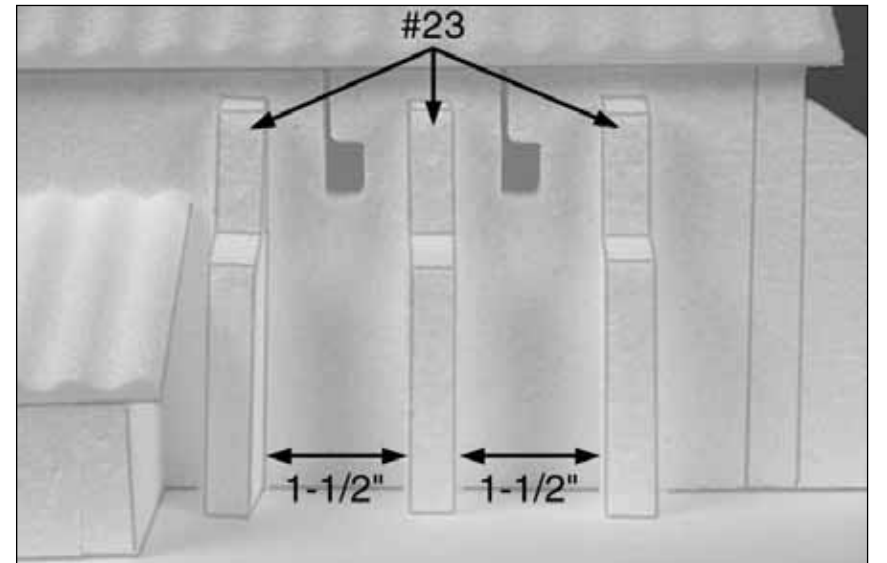

ASSEMBLY INSTRUCTIONS

1. Place the 24" x 15" cardboard or foam base on a clean, flat surface.
2. Apply glue to the front and rear edges of both #2 and #3 pieces (note direction). Put #1 and #4 into place as shown below. Make sure all edges are even. This section will be called the "main building."

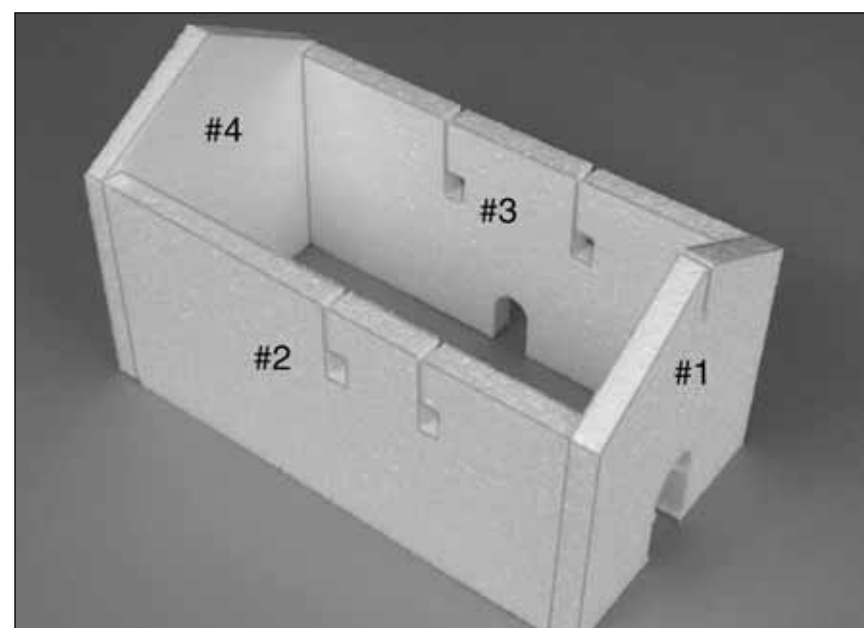
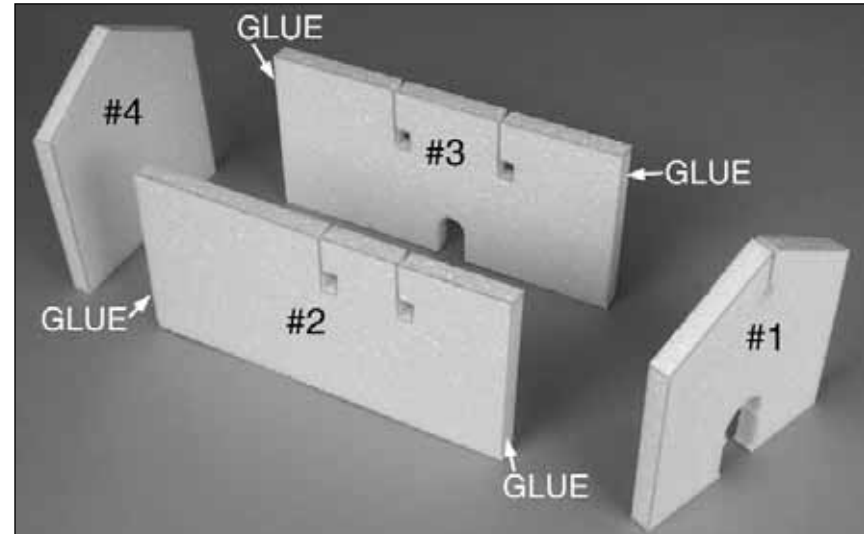

3. Apply glue to the side edges of both #5 pieces and put both #6 pieces in place as shown. Make sure the edges meet evenly. This section will be called the "bell tower."

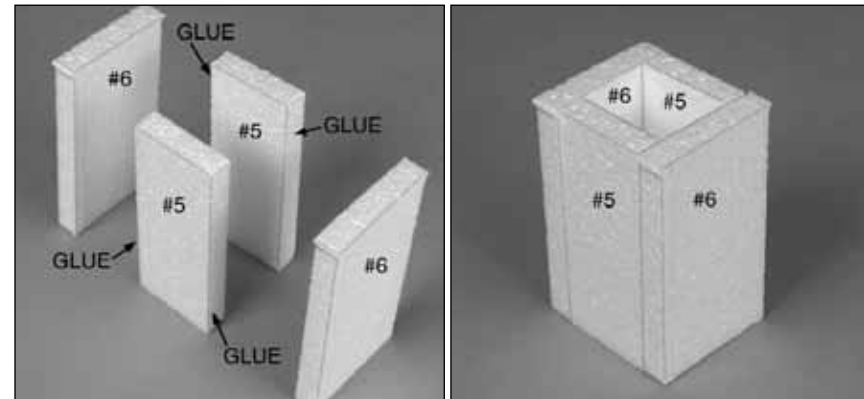

Important information about the pieces used in the next two steps: The two #7 pieces are larger than the two #9 pieces and the two #8 pieces are larger than the two #10 pieces.

4. Apply glue to the side edges of both #7 pieces and put both #8 pieces in place as shown below. Make sure the edges meet evenly. Glue this section in place atop the bell tower.

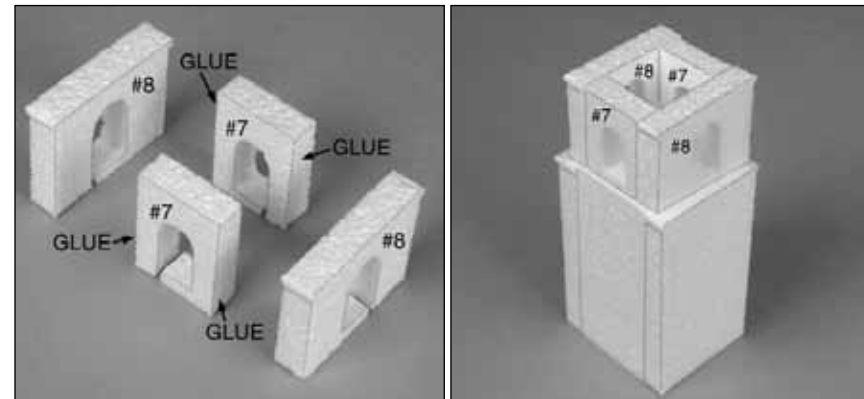

5. Apply glue to the side edges of both #9 pieces and put both #10 pieces in place as shown below. Make sure the edges meet evenly. Glue this section in place atop the bell tower.

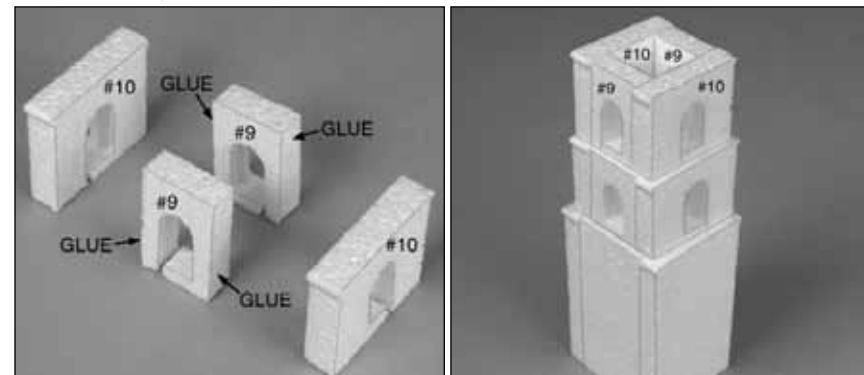

6. Glue the #11 dome pieces together as shown below and place them atop the bell tower.

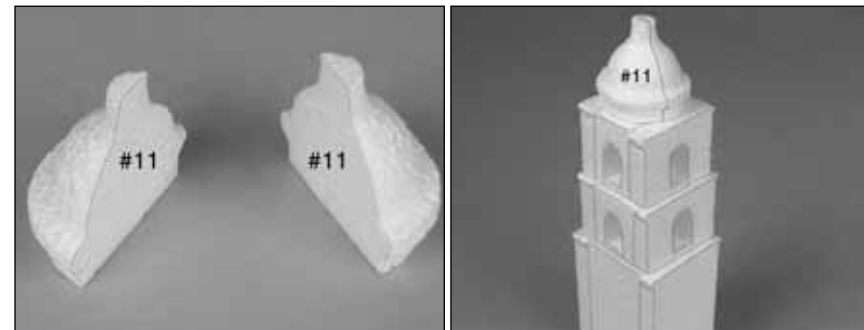

FINISHING

- When you paint your model, use only water-based paints.
- Check with your favorite hobby dealer for accessories such as grass, shrubbery, grave markers, action figures...etc. that will add realism to your model.