

Nuestra Senora de la Soledad Instructions

Parts Drawing

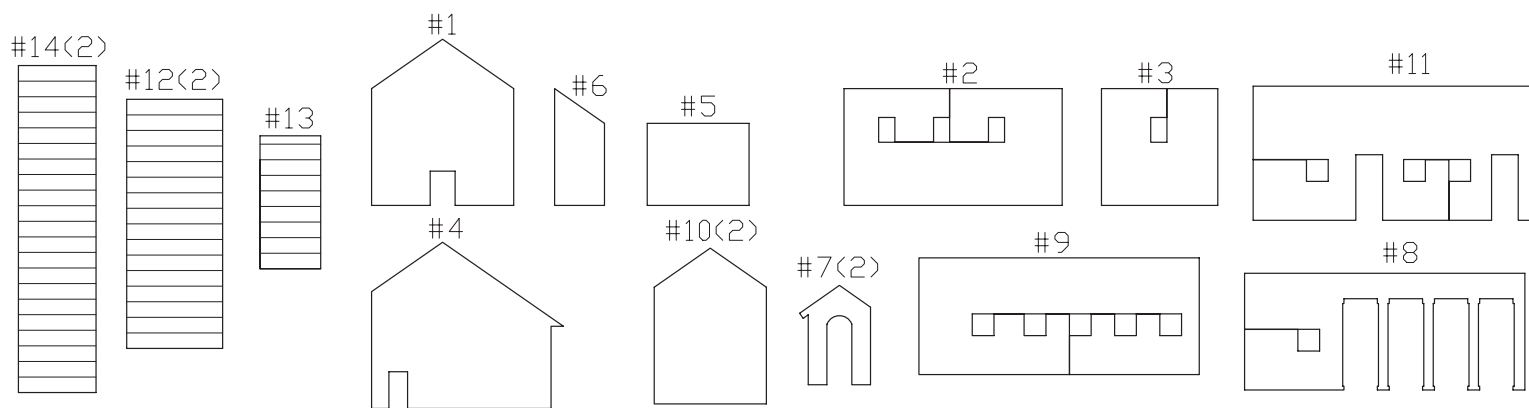

- Before starting assembly, read through each step of the instructions and carefully study each photo. As you put the model together, it is a good idea to "test" fit the pieces together before using any glue.
- Spread out newspaper across the table or desk that you are working on. This will help to protect your work surface.
- Use scissors to trim any pieces where needed. PARENTAL SUPERVISION is recommended.
- Identify each piece of the model by matching it with the parts drawing above.
- Assemble the model with standard white glue. It is a good idea to hold the pieces together with toothpicks until the glue is dry. Once the glue is dry, twist the toothpick and carefully pull it out.
- Use a small brush, flat stick, or your finger to spread glue evenly on the surface.
- Do not glue any of the pieces to the base until after Step 7.

Note: The missions can either be assembled on the cardboard sheet (included) or on a sheet of foam (not included).

- 8. Now that the basic sections are complete, they can now be glued to the base. Glue the main building in place so that there is 2" from the front of the base to the front door. The left side of the main building should be 3" from the edge of the base. Glue the quarters in place so that there is 8-1/2" from the front wall to the front edge of the base. The right side of the quarters should be 1/2" from the right edge of the base. This will leave you enough room to create scenery for your model.

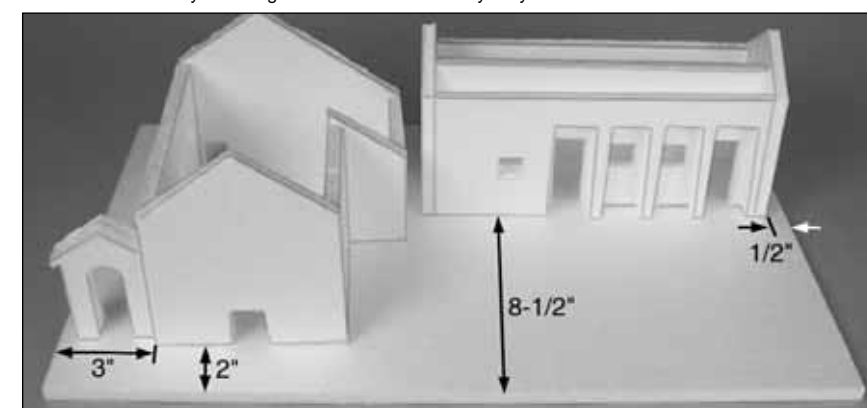

- 9. Apply glue to the roofline edges of #1, #4, and #6. Put both #12 pieces and the #13 piece into place as shown below.

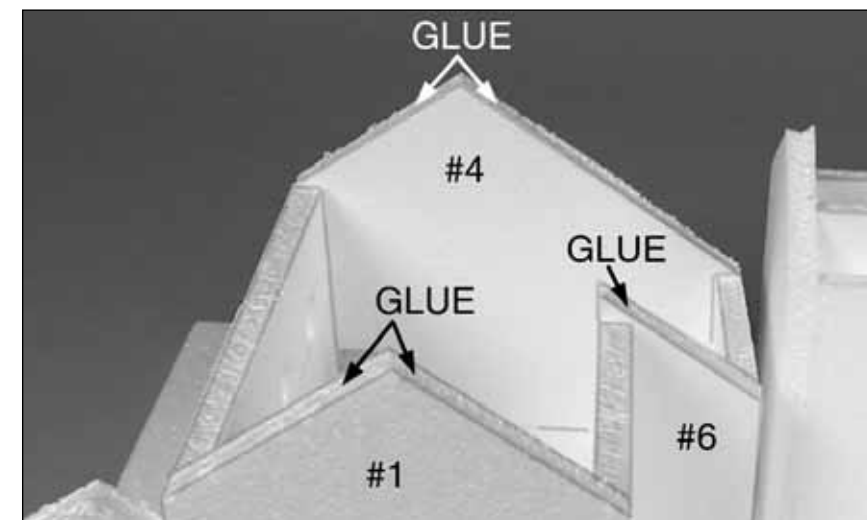

- 10. Locate both #14 pieces. This is the roof of the quarters. Apply glue to the roofline edges of both #10 pieces and put the #14 pieces in place as shown below.

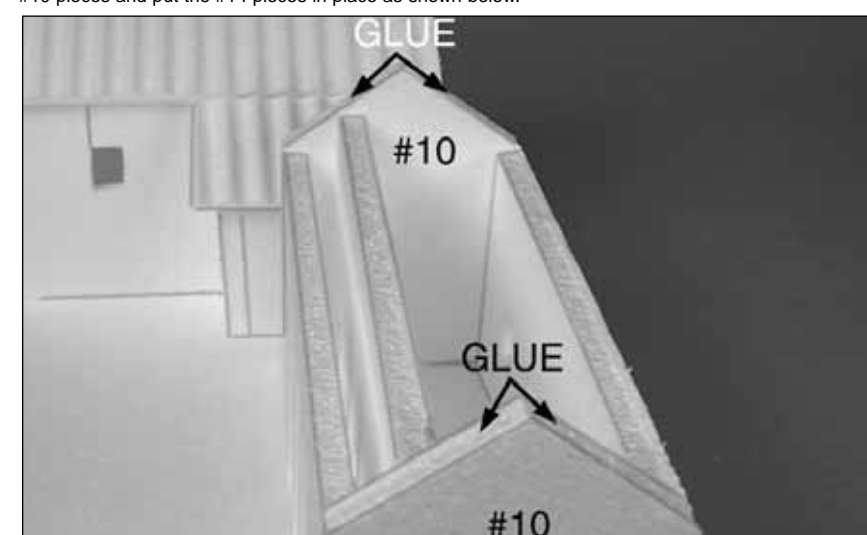

ASSEMBLY INSTRUCTIONS

- 1. Place the 24" x 15" base on a clean, flat surface.
- 2. Apply glue to the front edges of pieces #2 and #3 (note direction). Put #1 into place as shown below. Make sure all edges are even.

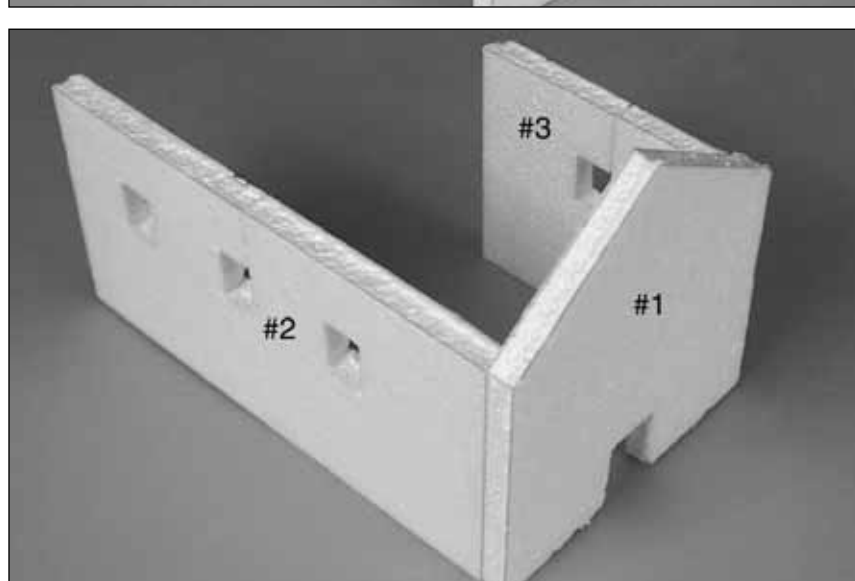
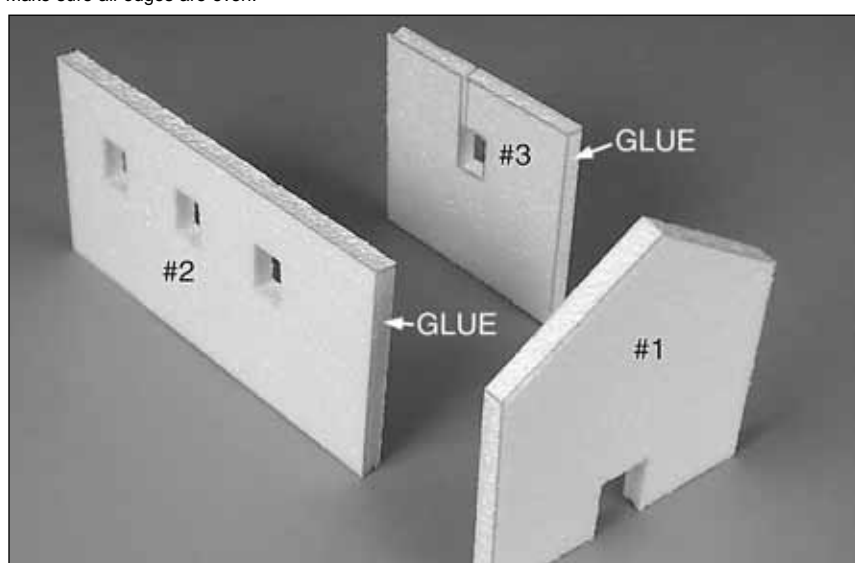

- 3. Apply glue to the short side edge of #4 and put #5 in place. Apply glue to the front edge of #5 and put #6 in place as shown below, making sure that the edges meet evenly.

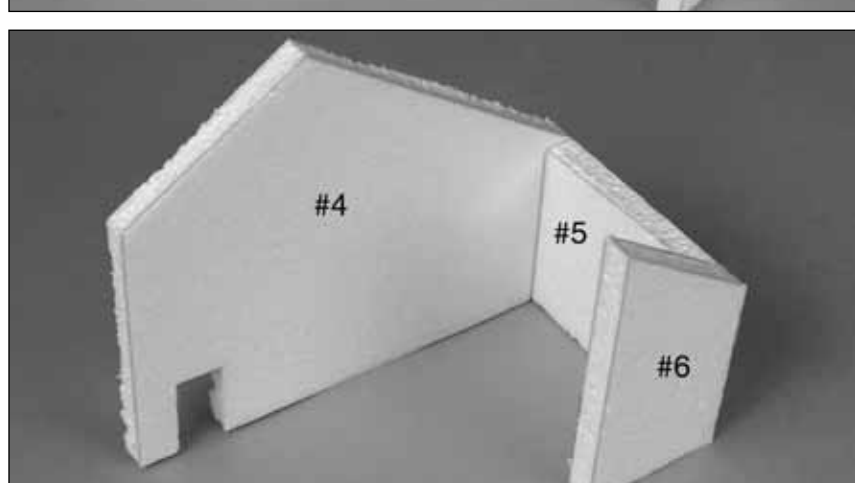
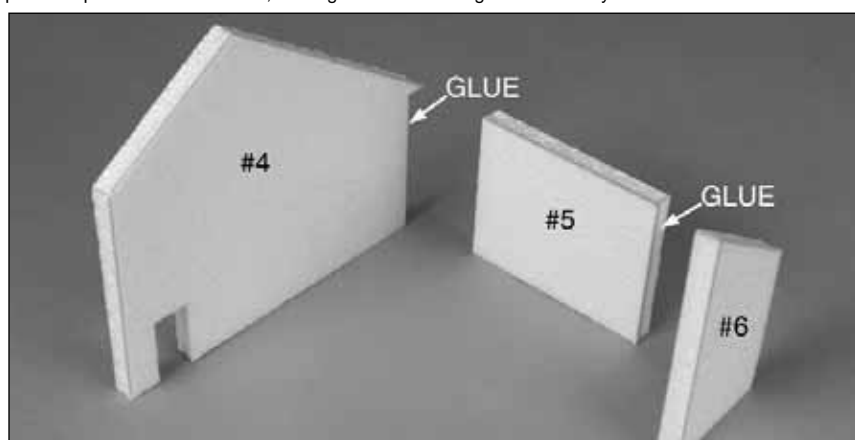

- 4. Apply glue to the rear edges of #2 and #3. Glue the sections from steps 2 and 3 together as shown in the two photos that follow. Make sure the edges meet evenly. This section will be called the "main building."

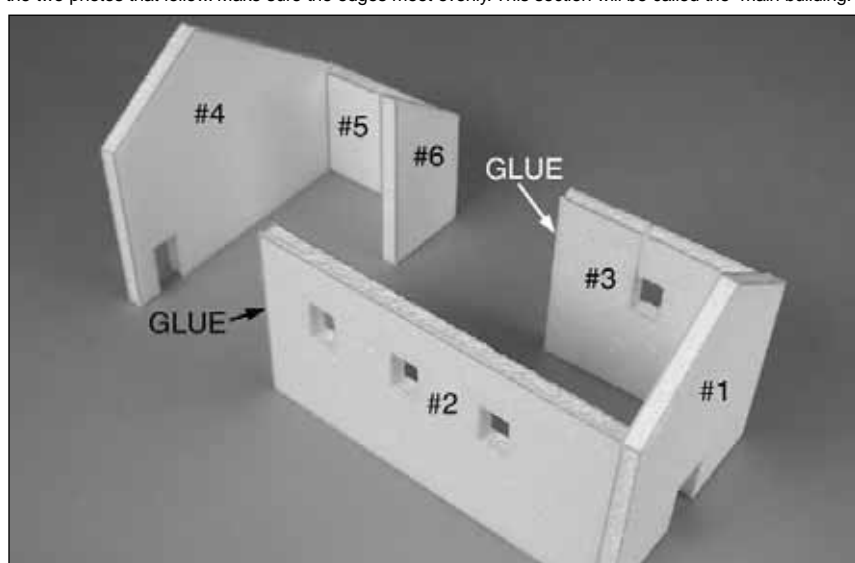

- 5. Glue both #7 pieces together. Glue them into place against #2 as shown below.

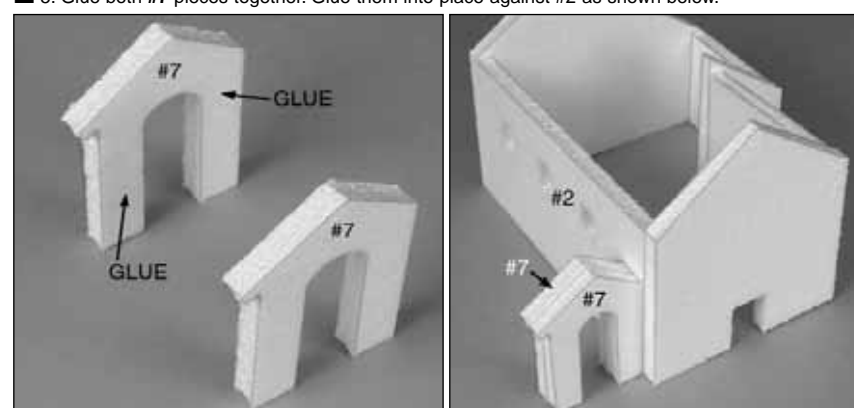

- 6. Apply glue to the side edges of #8 and #9. Put both #10 pieces in place as shown below. Make sure that the edges meet evenly. This section will be called the "quarters."

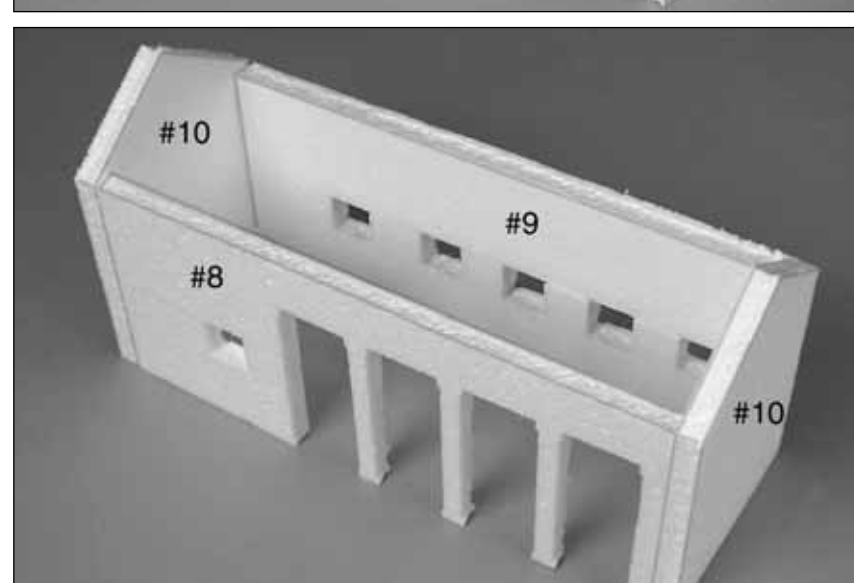
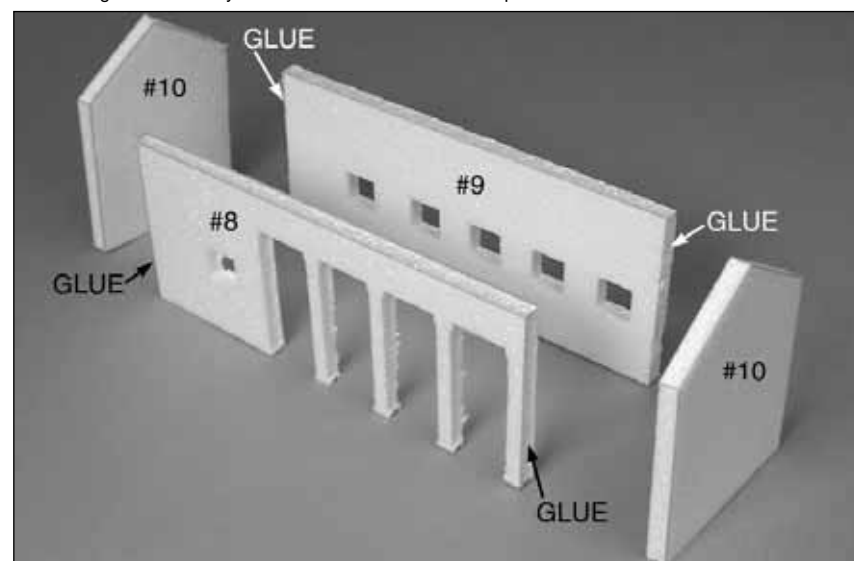

- 7. Apply glue to the side edges of #11. Put it in place as shown below. There should be a 1/2" space between #11 and #8.

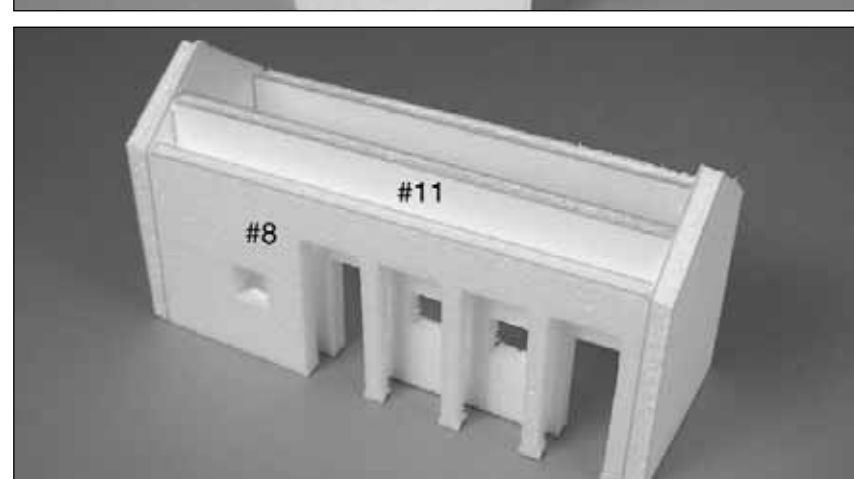
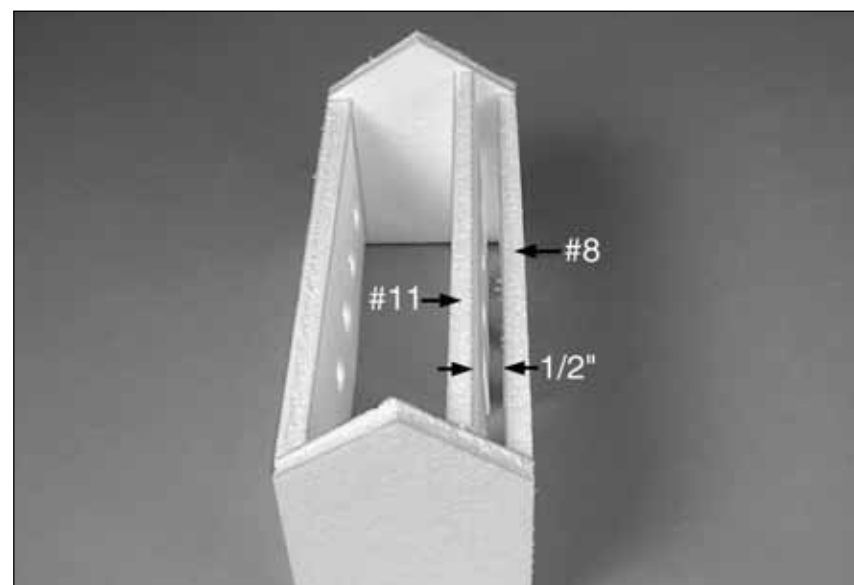

FINISHING

- When you paint your model, use only water-based paints.
- Check with your favorite hobby dealer for accessories such as grass, shrubbery, grave markers, action figures...etc. that will add realism to your model.