

# SUPERSTAR<sup>TM</sup> MKII *Select*



**Wingspan:** 60 in [1525mm]  
**Wing Area:** 660 sq in [43 dm<sup>2</sup>]  
**Weight:** 5.5 lbs [2490 g]  
**Wing Loading:** 19 oz/sq ft [58 g/dm<sup>2</sup>]  
**Length:** 49 in [1245mm]  
**Radio:** Futaba 4VF  
**Engine:** O.S. 40 LA (.40 cu in [6.5cc] two-stroke)

**THIS MANUAL IS FOR THE FOLLOWING PRODUCTS:  
HCAA60\*\*, HCAA61\*\* and HCAA62\*\***

## WARRANTY

**Hobbico®** guarantees this kit to be free from defects in both material and workmanship at the date of purchase. This warranty does not cover any component parts damaged by use or modification. In no case shall Hobbico's liability exceed the original cost of the purchased kit. Further, Hobbico reserves the right to change or modify this warranty without notice.

In that Hobbico has no control over the final assembly or material used for final assembly, no liability shall be assumed nor accepted for any damage resulting from the use by the user of the final user-assembled product. By the act of using the user-assembled product, the user accepts all resulting liability.

If the buyer is not prepared to accept the liability associated with the use of this product, the buyer is advised to return this kit immediately in new and unused condition to the place of purchase.

**READ THROUGH THIS MANUAL BEFORE STARTING CONSTRUCTION. IT CONTAINS IMPORTANT INSTRUCTIONS AND WARNINGS CONCERNING THE ASSEMBLY AND USE OF THIS MODEL.**

See more of our products at [www.hobbico.com](http://www.hobbico.com)



Champaign, Illinois  
(217) 398-8970, Ext. 5  
[airsupport@hobbico.com](mailto:airsupport@hobbico.com)

## Introduction

Congratulations and thank you for purchasing the Hobbico SuperStar MKII .40 Select. You've made the right decision by purchasing a "real" model airplane with a .40-size engine and a 4-channel radio. Once assembled and set up, there will be no fiddling with a temperamental engine or constant troubleshooting to figure out how to get the model to fly. Under the guidance of a flight instructor, all you'll have to do is concentrate on learning to fly. And after you've mastered the SuperStar MKII, the engine and radio may be installed in your next model!

There are two parts to this manual. The first part, **Assembly**, guides you through a few simple steps to put the model together. The second part, **Setup**, takes you through initial adjustments and flight preparation. **Do not** overlook any of the important setup procedures and follow the instructions **all the way to the end**. Anything skipped in the shop will have to be done at the field, which will take up some of your flight time.

The **best** thing you can do to insure success is to **find a flight instructor** who will inspect your model for airworthiness and provide flying lessons. It cannot be stated **strongly** enough that, if you do not already know how to fly an R/C airplane, you will probably **not** be able to fly this model by yourself. It may appear to be easy, but over-controlling and disorientation quickly overcome inexperienced fliers, swiftly ending their first flight. Many have tried to teach themselves, but most become discouraged and end up quitting the hobby, or destroy several models before they are able to solo. If you haven't yet done so, **contact the local hobby shop and ask them to introduce you to an instructor or an R/C club representative**. If there is no club or experienced R/C pilot nearby, it would be worth even a long drive to find one—if only for just a few flight lessons (then you'll have an idea of what to expect).

If there is no hobby shop in your area, contact the AMA (Academy of Model Aeronautics), the governing body of model aeronautics. The AMA can direct you to the closest R/C club whose membership should have qualified flight instructors. With the added benefit of insurance coverage provided by the AMA, most clubs require AMA membership to fly at their field.

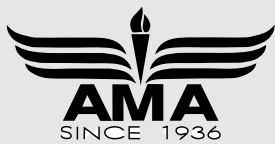

### Academy of Model Aeronautics

5151 East Memorial Drive  
Muncie, IN 47302-9252  
Tele. (800) 435-9262  
Fax (765) 741-0057

Or via the Internet at: <http://www.modelaircraft.org>

## Protect Your Model, Yourself and Others Follow these Important Safety Precautions

1. Your SuperStar MKII .40 Select should not be considered a toy, but rather a sophisticated, working model that functions very much like a full-size airplane. Because of its performance capabilities, the SuperStar MKII .40 Select, if not assembled and operated correctly, could possibly cause injury to yourself or spectators and damage to property.

2. You must assemble the model **according to the instructions**. Do not alter or modify the model, as doing so may result in an unsafe or unflyable model. In a few cases the instructions may differ slightly from drawings or sketches. In those instances the written instructions should be considered as correct.

3. You must check the operation of the model before **every** flight to insure that all equipment is operating and that the model has remained structurally sound. Be sure to check clevises or other connectors often and replace them if they show any signs of wear or fatigue.

We, as the kit manufacturer, provide you with a top quality kit and instructions, but ultimately the quality and flyability of your finished model depends on how you prepare it; therefore, we cannot in any way guarantee the performance of your completed model and no representations are expressed or implied as to the performance or safety of your completed model.

Before starting to build, inspect the parts in this kit to make sure they are of acceptable quality. If any parts are not of acceptable quality, or if you need assistance with assembly, contact:

**Hobbico Product Support**  
**Phone: (217) 398-8970, Ext. 5**  
**Fax: (217) 398-7721**  
**E-mail: [airsupport@hobbico.com](mailto:airsupport@hobbico.com)**

## Field Equipment

When ready to fly, you'll need the equipment to fuel the plane and start the engine. Perhaps you've already made arrangements with the R/C club or your flight instructor to borrow their equipment, but eventually you'll want to get your own. Refer to the side panel on the kit box cover for information on the **Hobbico ARF/RTF Field Pack (HCAP5115)**. This Field Pack contains the items you will need to go flying except for 10% Nitromethane Glow Fuel.



The items contained in the field pack above are:

- Hobbico Hand-Crank Fuel Pump (HCAP3015)
- Hobbico HOT SHOT™ 2 Glow Starter (HCAP2520)
- Hobbico Safety Stick Engine Starter (HCAP3335)
- Hobbico Recoil Fuel Tubing (HCAP2200)
- Great Planes® Silicone Field Tubing (GPMQ4131)
- Great Planes Fuel Can Fittings Set (GPMP4155)
- Top Flite® Power Point® 10x6 Propeller (TOPQ5085)
- Hobbico 4-Way Wrench (HCAP2550)
- O.S.® Max #A3 Glow Plug (OSMG2690)
- Field Tote

**You will also need a standard flat screwdriver, a Phillips screwdriver and a set of common household pliers for assembly and maintenance.**

## Assembly

### Charge the Batteries

❑ 1. In the fuselage (fuse), connect the plug from the battery pack, labeled "BATTERY 1", to the plug from the on/off switch, labeled "BATTERY 2."

❑ 2. As shipped, the rechargeable batteries in the SuperStar MKII are only **partially** charged. If you wish to begin assembly right away, go ahead and do so. If the batteries quit while performing the Setup procedures (beginning on page 4), they will have to be charged at that time for 16 hours. If you don't plan to begin assembly now, go ahead and charge the batteries for 10 hours now. To do so, connect the receiver charge cord coming from the charger to the connector coming from the on/off switch in the fuse labeled "CHARGE". Connect the other charge cord directly to the transmitter. After the "Setup" procedures have been performed, recharge the batteries for 10 hours. Fully discharged batteries will require approximately 16 hours to fully charge. In any case, the batteries **must** be charged before you go flying. For additional battery charging information refer to the **Futaba** instruction manual included with this kit.

### Assemble the Wing

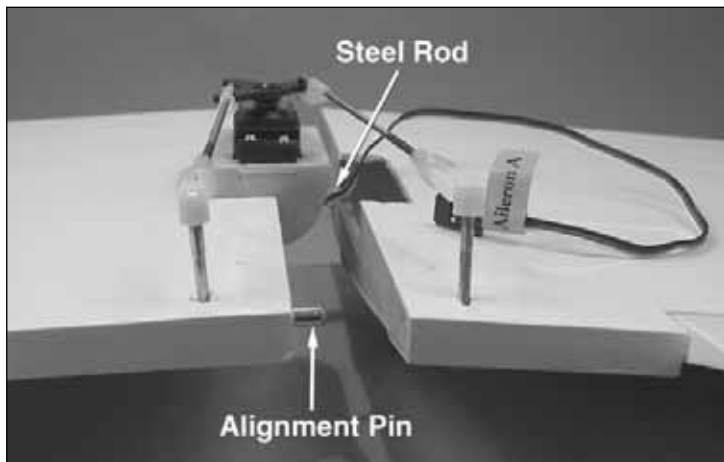

❑ 1. Note the metal **alignment pin** in right wing half. Insert the **steel rod** into the wing. Then, slide both halves together, aligning the pin in the trailing edge.

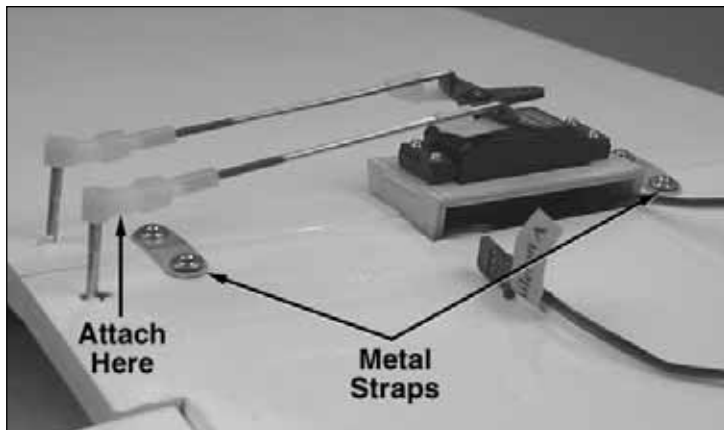

❑ 2. Use the two **metal straps** and four 3 x 6mm screws to hold the wing halves together. Connect the one unattached **pushrod** to the **torque rod horn** with the clevis and clevis retainer.

### Assemble the Fuselage



❑ 1. Insert the **stabilizer** (stab) into the fuse.

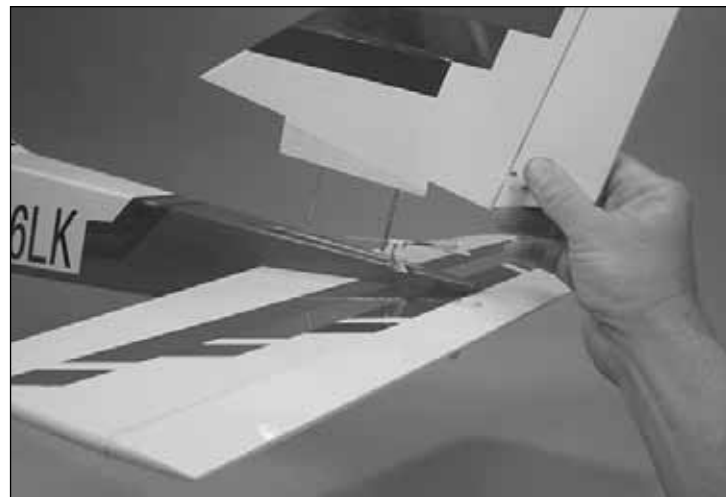

❑ 2. Insert the **fin** into the stab, guiding the metal rods through the holes in the stab and the bottom of the fuse. Secure the fin and stab with a flat washer and a 3mm locknut. Be certain to tighten the nuts securely, but do not over tighten so as to damage the bottom of the fuse.

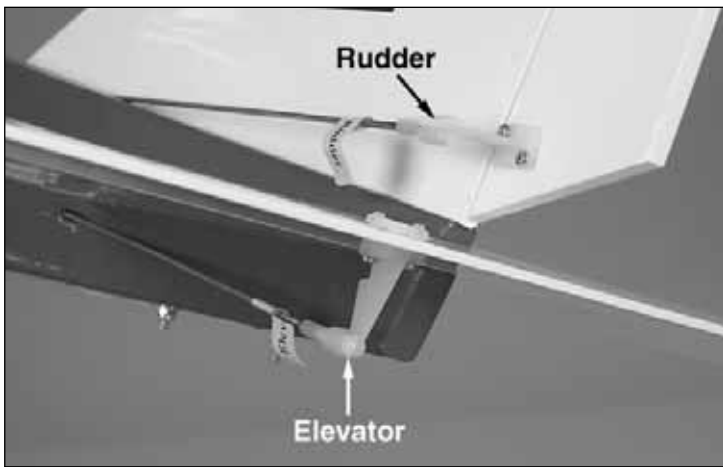

❑ 3. Connect the elevator pushrod to the **fourth** hole out from the base of the control horn on the elevator control horn. Connect the rudder pushrod to the **second** hole out from the base of the rudder control horn.

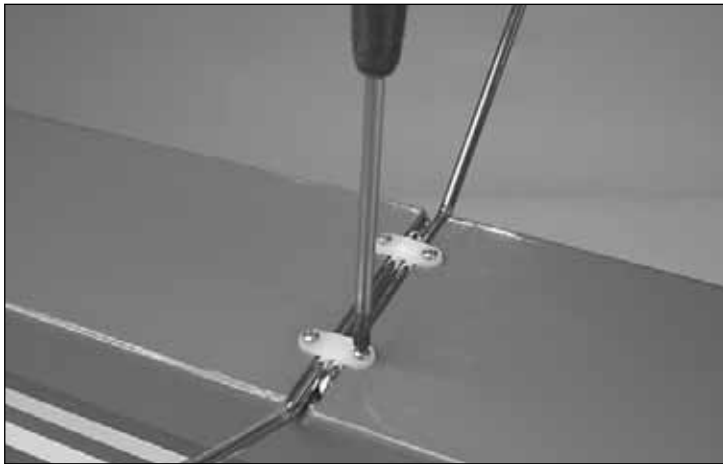

❑ 4. Insert the **main landing gear wires** into the holes in the landing gear blocks in the bottom of the fuselage. Secure the gear with two **nylon straps** and four 2.5 x 12mm screws.

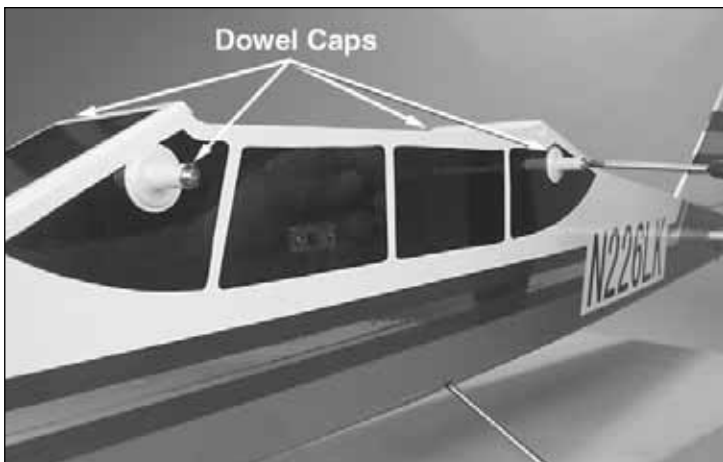

❑ 5. Insert the **wood dowels** into the fuselage. Note that one is longer and is placed toward the front of the model. Secure the dowels with a **plastic dowel cap** and a 3 x 4mm screw on each end.

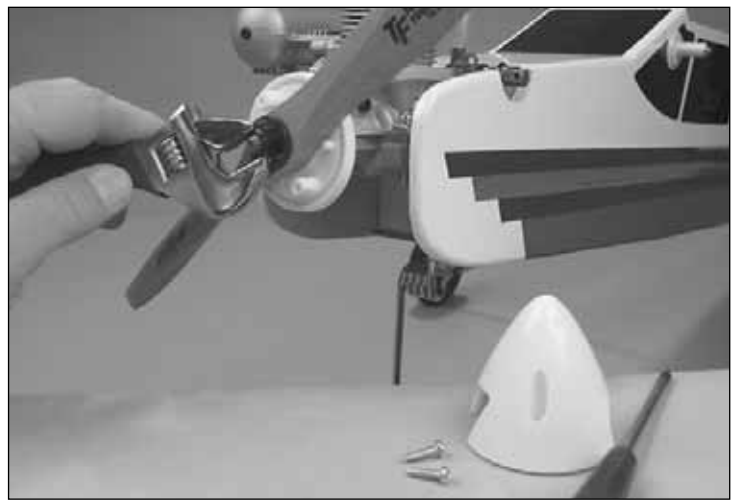

❑ 6. Fit the spinner back plate, followed by the prop, prop washer and prop nut, on the engine. Use a 10mm wrench or a crescent wrench to securely tighten the prop nut.

❑ 7. Fit the spinner cone to the backplate, then use a #1 Phillips screwdriver to tighten the spinner screws. Be careful to tighten these screws all the way but do not over-tighten as the plastic material can strip out rather easily.

### Setup

Now the plane is assembled, but there are a few things that **must** be done before it will be ready to fly. You must carefully perform **all** of the following **Setup** procedures.

If you have not yet charged the batteries, you may continue with the setup procedures. However, if you have not charged the batteries at this time it is important that you read and follow the information at the beginning of the "Assembly" section of this manual.

### Check the Control Directions

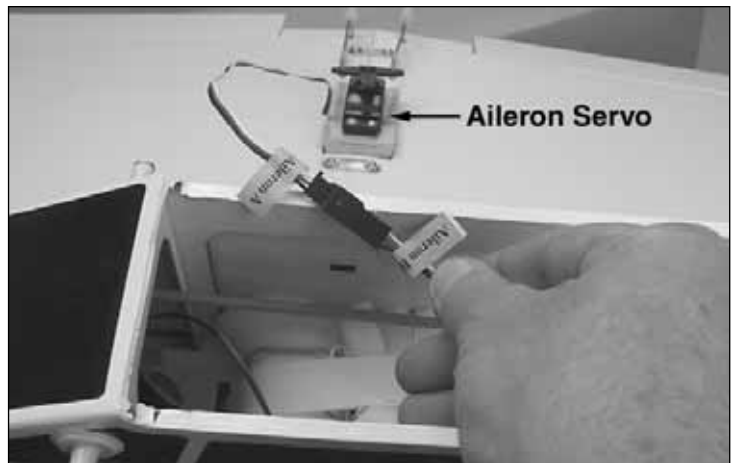

❑ 1. Connect the aileron servo plug labeled "AILERON A" to the plug labeled "AILERON B" coming from the receiver inside the fuselage. Temporarily mount the wing to the fuselage with a couple of rubber bands.

❑ 2. Turn on the transmitter, followed by the receiver. (The goal is to never have the receiver on by itself. When turning off the system, turn off the receiver first, then the transmitter.)

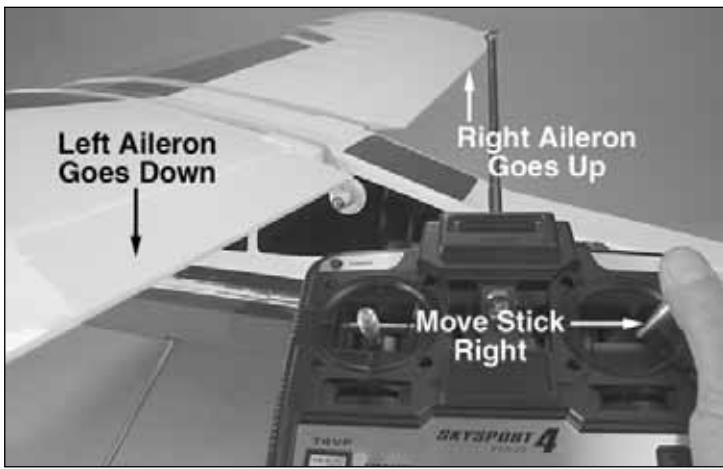

3. Move the aileron control stick on the transmitter as shown to be certain the ailerons respond in the correct direction. Check the remaining controls in the same manner and if any of the controls move the wrong way, use the servo reversing switches on the transmitter to make the controls respond correctly. If necessary, refer to the instructions in the Futaba instruction manual to identify and operate the reversing switches.



Note that pulling the elevator stick back moves the elevator up which, in flight, pushes the tail down, thus raising the nose of the plane to climb.

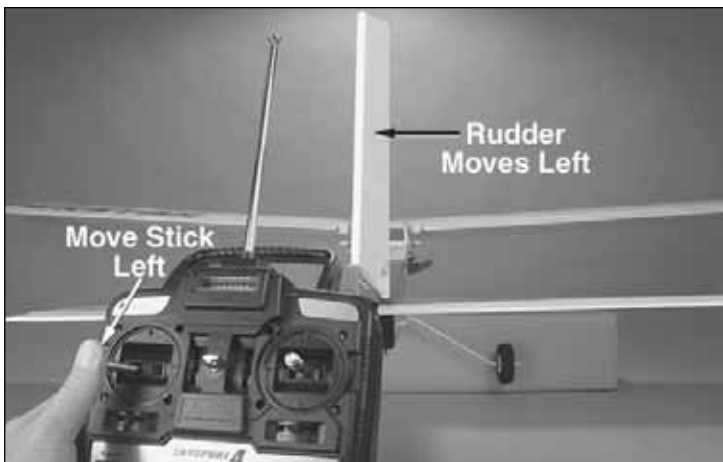

Also note that pushing the rudder stick to the left moves the rudder and the nose wheel to the left which, in flight, pushes the nose to the left, thus turning the airplane to the left and while on the ground, steering the nose to the left.

## Center the Controls

**Note:** We strive to maintain constant quality control in order that your new SuperStar MKII Select will be pre-adjusted properly. Please be sure to check these adjustments on your airplane as instructed below in order to guarantee that your first flight will be a pleasant experience.

The control surfaces (ailerons, elevator, rudder) are to be centered when the control sticks and trims are centered. Here's how to do it:

1. Do the elevator first. With the transmitter and receiver on, center the aileron, elevator and rudder trim levers on the transmitter.

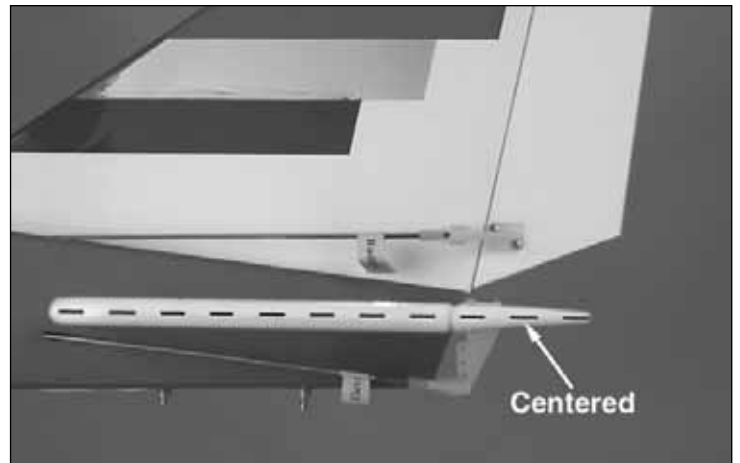
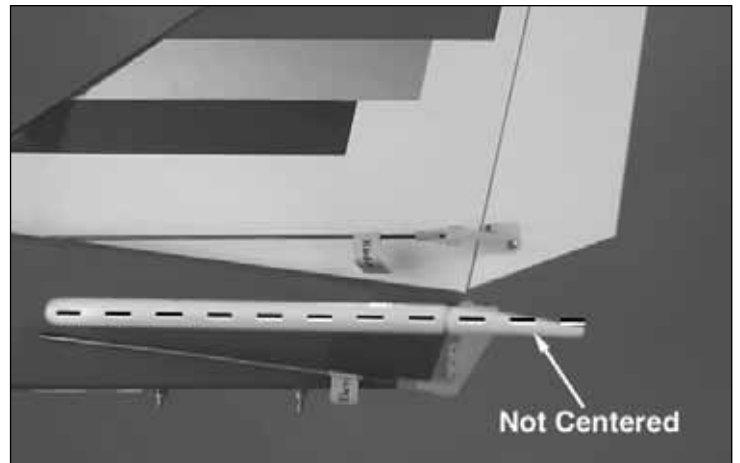

2. View the elevator and stab from the end. If the elevator is not centered with the stab (as shown in the photograph above), disconnect the clevis from the elevator horn. Holding the end of the pushrod with pliers, screw or unscrew the clevis as necessary until the elevator will be centered when reconnected to the pushrod.

3. Center the rudder and both ailerons the same way. When finished, be certain to reconnect all the clevises with the retainers.

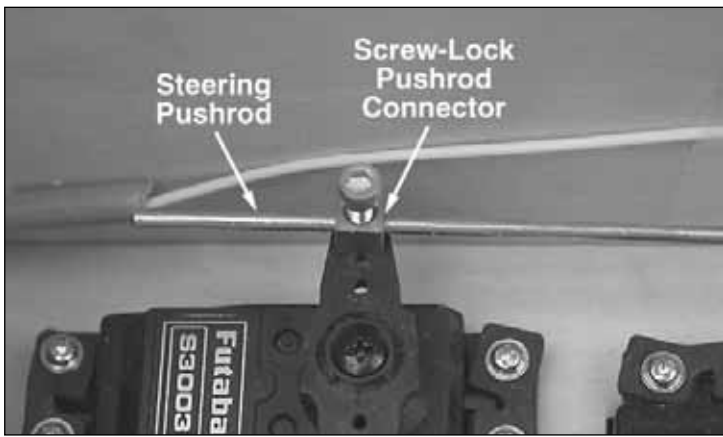

❑ 4. Center the nose wheel by adjusting the pushrod in the screw-lock pushrod connector on the rudder servo.

### Adjust the Throttle

The throttle is to be set up so that when the throttle stick is all the way **down** and the throttle trim lever is all the way **up**, the carburetor barrel will be *nearly* closed and the engine will run at a low RPM ("idle"). This will allow the engine to keep running when the throttle stick is pulled all the way down (toward you) for landing. When it *is* time to shut the engine off after landing, move the trim lever down to close the carburetor barrel the rest of the way.



❑ 1. With the transmitter and receiver on, move the throttle trim lever and the throttle stick all the way down.

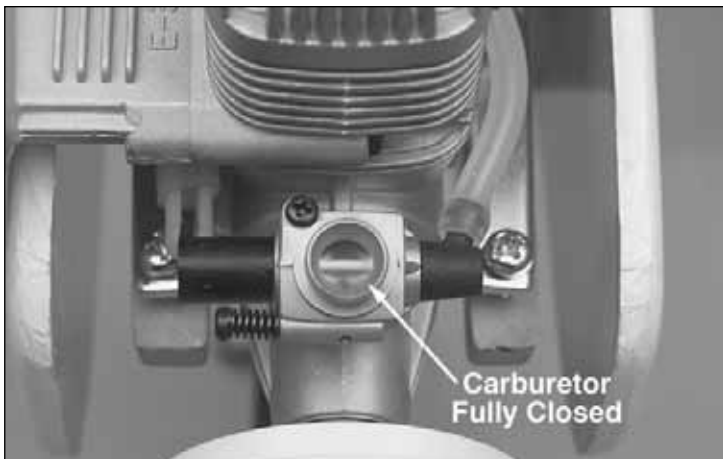

❑ 2. Observe the opening in the carburetor. If the carburetor is fully closed, proceed to step 3. If the carburetor is nearly, but

not fully closed, loosen the screw on the screw-lock connector on the throttle servo arm and move the pushrod forward until the carburetor is closed. Securely tighten the screw.

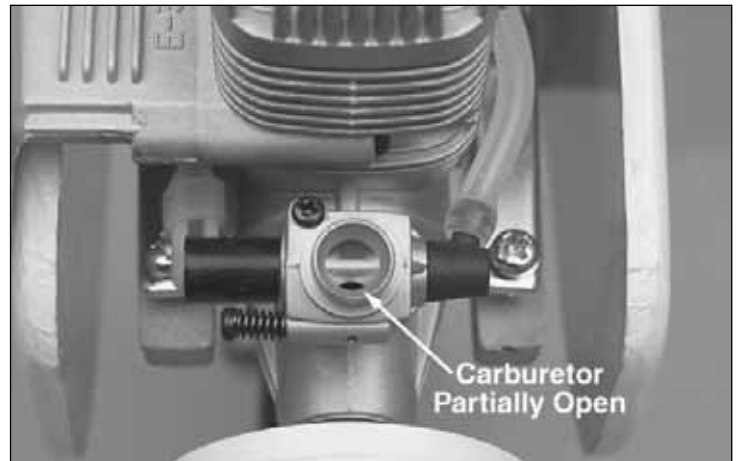

❑ 3. Move the throttle trim lever all the way up, but leave the throttle stick all the way down. Now the carburetor should be partially open about 1/32" to 1/16" [1 to 2mm].

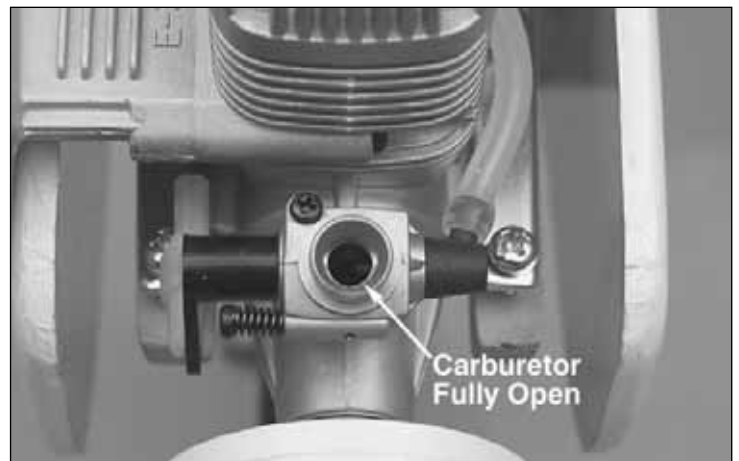

❑ 4. Move the throttle stick all the way up. The carburetor should be fully open.

❑ 5. If you are not able to achieve these settings, more or less movement may be required from the throttle pushrod. This is done by relocating the clevis on the carburetor arm to the other hole, or by relocating the pushrod connector on the servo arm to another hole. From the factory, the connector on the servo arm should be in the third hole out from the center and the clevis on the carburetor should be in the hole closest to the screw.

## Set the Control Throws

The control throws are a measure of how far the flight controls move up and down (or from side to side). If the controls move too much, the plane will respond too quickly and be difficult to control. Due to the **great** effect the control throws have on the way a model flies, the control throws **must** be checked.

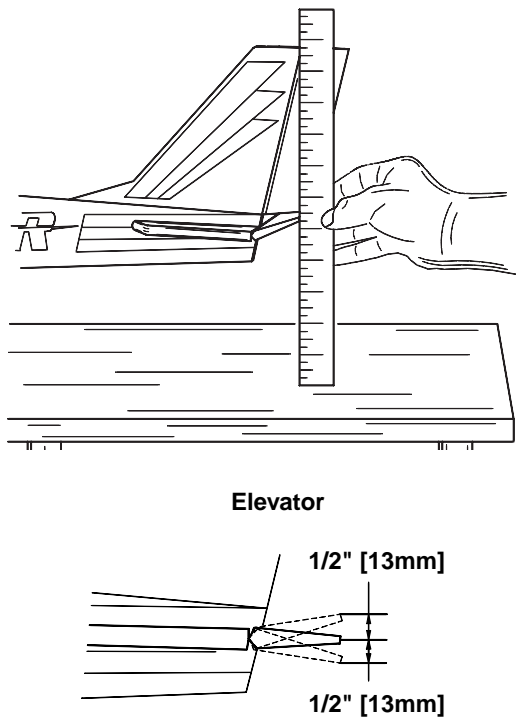

1. Start with the elevator. Turn on the transmitter and receiver. Holding a ruler up to the trailing edge of the elevator, move the elevator all the way up using the control stick on the transmitter. Measure the distance the elevator moves up. Also move the elevator down and measure the distance. As shown in the chart that follows, the elevator should move 1/2" [13mm] up and 1/2" [13mm] down. If the elevator moves up or down more than 1/2" [13mm], the control throw must be **decreased** by connecting the pushrod to a hole **further out** on the elevator control horn, or by connecting the pushrod to a hole **further in** on the elevator servo arm (as shown in the sketch below). If the elevator doesn't move up and down enough, the control throw may be **increased** by relocating the pushrods the opposite as described above.

### Control Throws

<b>Elevator</b>	1/2" [13mm] up	1/2" [13mm] down
<b>Ailerons</b>	5/16" [8mm] up	5/16" [8mm] down
<b>Rudder</b>	1" [25mm] right	1" [25mm] left

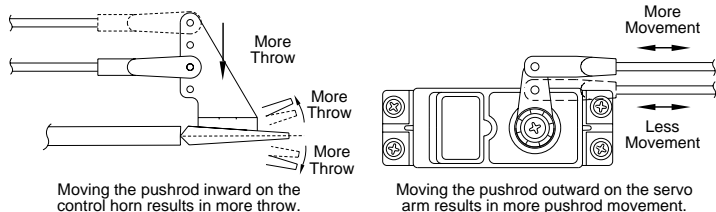

2. Measure and if necessary, adjust the aileron and rudder control throws the same way.

## Identify Your Model

Whether you fly at an R/C club or somewhere on your own, you should have your name, telephone number and address in or on your model so it can be identified and returned in case it lands somewhere away from the flying site. Fill out the I.D. tag found in the back of the manual and use spray adhesive or tape to stick it in the model.

## Balance the Model

This important step may also be referred to as "checking the C.G." (center of gravity). **Do not disregard this step.** The C.G. can have an even greater effect on how a model flies than the control throws. If the model has too much weight in the nose ("nose-heavy"), it could be difficult to takeoff and land and lose some of its self-correcting tendencies. If the model has too much weight in the tail ("tail-heavy"), the controls may be too sensitive, making the model too difficult to control—especially for an inexperienced pilot!

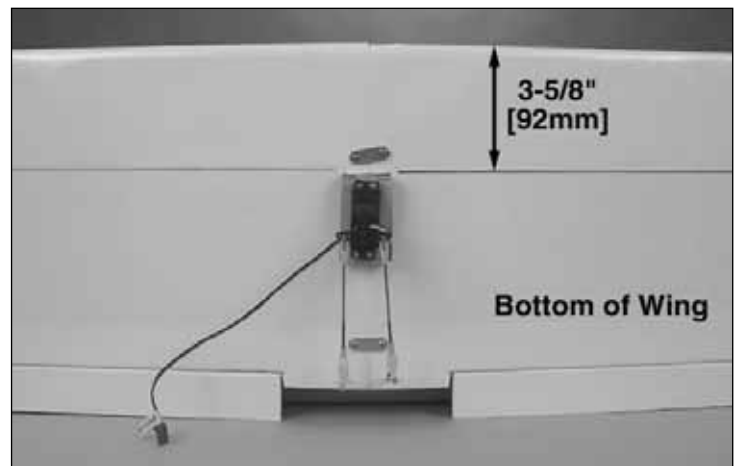

1. Take the wing off the fuselage. Use a felt-tip pen to mark a line on the bottom of the wing to note the balance point **located 3-5/8" [92mm] back from the leading edge** as shown in the photo.



2. Mount the wing on the fuse with four rubber bands. Lift the model on both sides of the fuselage with your fingertips on the line on the bottom of the wing.

3. With your fingers on the line, if the plane will rest level, the C.G. is good. Proceed to the checklist in the following section. If the tail drops, add weight to the nose until the plane balances. If the nose drops the plane is nose heavy and will require sticking weight on the tail to balance.

If additional weight is required to balance the plane, purchase Great Planes Self Adhesive Lead Weights (GPMQ4485). If adding tail weight, stick the weight to the side of the fuse under the stab. If adding nose weight, stick the weight to the inside of the fuselage side next to the engine.

- 4. If you found it necessary to add weight, recheck the C.G. after adding the weight.

### Ten-Point Checklist

Now it's time to do a final check before taking the model to the field. These checks are best done in the peace and comfort of your own shop, so take the time now to make certain your model is ready.

- 1. Use a 1/16" hex wrench to check to see that the screws on all the wheel collars that hold the wheels on are secure.
- 2. Be certain the silicone retainers on all the nylon clevises are in position.
- 3. Make certain the elevator, rudder and ailerons respond in the correct directions.
- 4. Make certain the wing is securely joined with the metal straps and the metal rod.
- 5. Check to see that the nuts that hold the fin and stab in position are present and secure.
- 6. Inspect the rubber bands that hold the wing on and make sure they are in good condition.
- 7. Make certain the propeller and propeller spinner are secure.
- 8. Make certain you have balanced the model according to the instructions.
- 9. Check to see that the screws that hold the servo arms to the servos are present and secure.
- 10. Make certain you have filled out the I.D. card and placed it inside the model.

### Charge the Batteries

If you haven't already done so, refer to the instructions in the Assembly section on page 3 and charge the batteries overnight the night before you go flying.

### Gather Your Tools

In addition to the engine starting equipment mentioned near the beginning of the manual, you should start a collection of tools that may be required for adjustments and maintenance at the flying field. Following is a list of the most recommended items.

#### Tools:

- #1 Phillips screwdriver
- #2 Phillips screwdriver
- 5/16" (or 8mm) socket wrench (for glow plug)
- 1/16" hex wrench (for wheel collars)
- 10mm wrench or crescent wrench (for propeller nut)
- Pliers
- Hobby knife

#### Spare parts:

- 10 x 6 propellers
- #64 rubber bands (stored in container with talcum powder or kitty litter)
- Glow plug

## Flight Preparation

Flight preparation is to be done at the flying field.

### IMPORTANT!!!

*Flying a model with too few rubber bands can be dangerous. If the wing momentarily lifts from the fuselage and acts as though a large amount of "up" elevator has suddenly been applied because there are not enough rubber bands or they are too weak, internal structural damage may result. Even worse, the wing could actually detach from the fuselage resulting in a crash. If the model exhibits any tendencies that indicate there are not enough rubber bands, immediately reduce power, land and closely inspect the model for damage. If no damage is found, add more rubber bands.*

**IMPORTANT!!!** Your radio control system transmits a signal on a certain frequency. Be certain you know what the frequency is. This is expressed as a two-digit number (42, 56, etc.) and can be found on the container the transmitter came in and is also located on the transmitter. There are several different frequencies, but there is still a chance that someone else at the flying field may be on the same frequency as you. If you turn on your transmitter while that person is flying, a crash will result. **NEVER** turn on your transmitter until you have permission from your instructor and until you have possession of the frequency clip used for frequency control at the flying site.

### **BE CERTAIN YOUR FLIGHT INSTRUCTOR PERFORMS THESE FOLLOWING CHECKS WITH YOU.**

#### Check the Controls

- 1. Get the frequency clip from the frequency control board at your flying site.

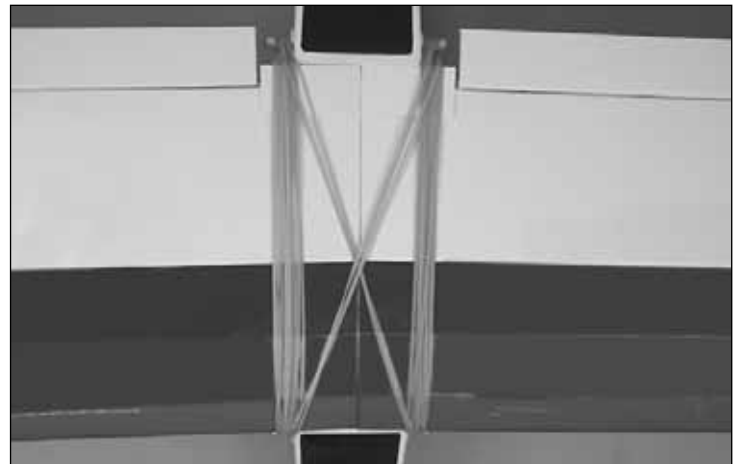

- 2. Mount the wing to the fuselage with the #64 rubber bands supplied with this kit. Twelve rubber bands are suggested. Be certain the final two are "crisscrossed," thus ensuring that the others remain secure.
- 3. Turn on the transmitter and receiver. One at a time, operate each control on the airplane using the sticks on the transmitter. Make certain each control is responding correctly. This **must** be done before **every** flight. There are several types of malfunctions that can be discovered by performing this elementary task, thus saving your model!



## Range Check the Radio

A range check **must** be performed before the **first** flight of a new model. It is not necessary to do a range check before every flight (but is not a bad idea to perform a range check before the first flight of each day). A range check is the final opportunity to reveal any radio malfunctions and to be certain the system has adequate operational range.

❑ 1. Turn on the transmitter and receiver. Leave the transmitter antenna all the way down. Walk away from the model while simultaneously operating the controls. Have an assistant stand by the model and tell you what the controls are doing to confirm that they operate correctly. You should be able to walk approximately 100 [30m] feet from the model and still have control without any “glitching” or inadvertent servo operation.

❑ 2. If everything operates correctly, return to the model and start the engine. Perform the range check with your assistant holding the plane with the engine running at various speeds. If the servos chatter or move inadvertently, there may be a problem. **Do not** fly the plane! With the assistance of your instructor, look for loose servo connections or binding pushrods. Also be certain you are the only one on your frequency and that the battery has been fully charged.

## Flying

The following flying instructions are in no way an endorsement for learning to fly on your own, but are printed so you can know what to expect and what to concentrate on while learning under the tutelage of your instructor. Further, these flight instructions may be referenced once you begin flying on your own.

**IMPORTANT:** If you do insist on flying on your own, you **must** be aware of your proximity to R/C club sites. If there is an R/C site within six miles of where you are flying and if you are operating your model on the same frequency and at the same time as somebody else, there is a **strong** possibility that one or both models will crash due to radio interference. There is **great** potential for an out-of-control model to cause property damage and/or severe personal injury. We **strongly** urge you to fly at a R/C club site where frequency control is in effect so you can be assured you will be the only one flying on your channel.

## Taxiing

**Remember, it is assumed that your instructor is operating the model for you.**

Before the model is ready for takeoff, it must first be set up to roll straight down the runway. With the engine running at a low idle, place the plane on the runway and, if your flying field permits, stand behind the model. Advance the throttle just enough to allow the model to roll. If the model does not roll straight down the runway, shut the engine off and adjust the nose gear pushrod as necessary. Do not use the rudder trim to

correct the nose wheel because this will also affect the rudder. **Note:** Crosswinds may affect the direction the model rolls, so this test should be done in calm conditions, or with the model facing directly into the wind.

## Takeoff

If possible, takeoff **directly into** the wind. If you are experienced, taking off in a crosswind is permissible (and sometimes necessary—depending upon the prevailing wind conditions and runway heading). Taking off into the wind will help the model roll on a straight path and also reduces ground speed for takeoff. Taxi the model onto the runway or have an assistant carry it out and set it down pointing into the wind down the runway. When ready, gradually advance the throttle while simultaneously using the left stick (rudder/nose wheel) to steer the model. Gain as much speed as the runway and flying site will practically allow before gently applying up elevator, lifting the model into the air. A good method to remember is to apply pressure to the sticks rather than pulling or pushing on them. Be ready to make immediate corrections with the ailerons to keep the wings level and be smooth on the elevator stick, allowing the model to establish a gentle climb to a safe altitude before making the first turn (away from yourself). Do not “yank” back the elevator stick forcing the plane into too steep of a climb which could cause the model to quit flying and stall.

## Flight

Once airborne, maintain a steady climb and make the initial turn away from the runway. When at a comfortable, safe altitude throttle back to slow the model, thus giving you time to think and react. The SuperStar MKII .40 Select should fly well at half or slightly less than half-throttle. Adjust the trims so the plane flies straight and level. After flying around for a while and while still at a safe altitude with plenty of fuel, practice slow flight and execute practice landing approaches by reducing the throttle further to see how the model handles when coming in to land. Add power to see how the model climbs as well. Continue to fly around while learning how the model responds. Mind your fuel level, but use this first flight to become familiar with the model before landing.

## Landing

When ready to land, pull back the throttle stick fully while flying downwind just before making the 180-degree turn toward the runway. Allow the nose of the model to pitch downward to gradually bleed off altitude. Continue to lose altitude, but maintain airspeed by keeping the nose down while turning. Apply up elevator to level the plane when it reaches the end of the runway and is about five to ten feet off the ground. If the model is too far away, carefully add a small amount of power to fly the model closer. If going too fast, smoothly advance the throttle and allow the model to gain airspeed, then apply elevator to climb-out and go around to make another attempt. When finally ready to touch down, continue to apply up elevator, but not so much that the airplane will climb. Continue to apply up elevator while the plane descends until it gently touches down.

After you have landed and shut the engine off, adjust the pushrods on the ailerons, elevator and rudder as necessary so the trim levers on the transmitter may be returned to center (this will not be required on any of the controls that did not need trim adjustments).

### Maintenance Tips

- 1. After flying for the day, don't forget to use your fuel pump to drain excess fuel from the tank.
- 2. Do not reuse torn or oily rubber bands. Purchase spare rubber bands (HCAQ2020, 1/4 lb. box). After flying, oily rubber bands should be stored in a container with talcum powder or kitty litter. This will absorb oil and keep the rubber bands fresh for the next flying session.
- 3. After each day's flying, use spray cleaner and paper towels to thoroughly clean the model.
- 4. The SuperStar MKII Select is factory-covered with Top Flite MonoKote film. Should repairs ever be required, MonoKote can be patched with additional MonoKote purchased separately. MonoKote is packaged in six-foot rolls, but some hobby shops also sell it by the foot. If only a small piece of MonoKote is needed for a minor patch, perhaps a fellow modeler would give you some. MonoKote is applied with a model airplane covering iron, but in an emergency a regular iron could be used. A roll of MonoKote includes full instructions for application.

### Ordering Replacement Parts

To order replacement parts for the SuperStar MKII .40 Select, use the order numbers in the **Replacement Parts List** that follows. Replacement parts are available only as listed. Not all parts are available separately (an aileron cannot be purchased separately, but is only available with the wing kit). Replacement parts are not available from Product Support, but can be purchased from hobby shops or mail order/Internet order firms. Hardware items (screws, nuts, bolts) are also available from these outlets. If you need assistance locating a dealer to purchase parts, visit [www.greatplanes.com](http://www.greatplanes.com) and click on "Where to Buy." If this kit is missing parts, contact **Great Planes Product Support**.

### Replacement Parts List

Order Number	Description	How to purchase
	Missing pieces.....	Contact Product Support
	Instruction manual.....	Contact Product Support
	Plans.....	Not available

*For the following items, contact your hobby supplier:*

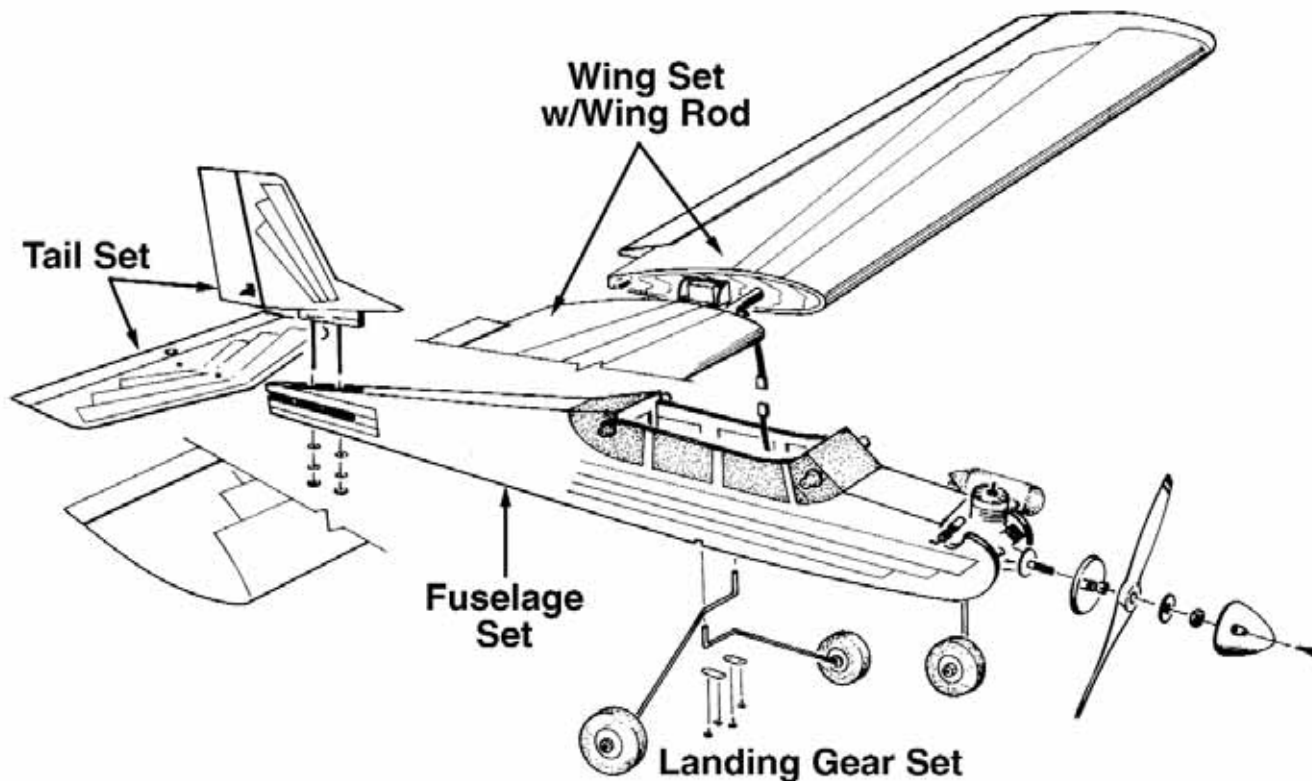

<b>HCAA60** (Blue, Red, Yellow)</b>	<b>HCAA61** (Red, Blue, Chrome)</b>	<b>HCAA62** (Yellow, Red, Orange)</b>
HCAA3726 .....Wing Set	HCAA3730 .....Wing Set	HCAA3733 .....Wing Set
HCAA3727 .....Fuse Set	HCAA3731 .....Fuse Set	HCAA3734 .....Fuse Set
HCAA3728 .....Tail Set	HCAA3732 .....Tail Set	HCAA3735 .....Tail Set
HCAA3708 .....Landing Gear Set	HCAA3708 .....Landing Gear Set	HCAA3708 .....Landing Gear Set

**Other Items Available from Hobbico**



Wingspan: 59 in (1500mm)  
 Wing Area: 602 sq in (39dm<sup>2</sup>)  
 Flying Weight: 5.0 lb (2270g)  
 Wing Loading: 19 oz/sq ft (58g/dm<sup>2</sup>)  
 Length: 48 in (1220mm)  
 Requires: 2-stroke .40 cu in (6.5cc) engine  
 & 4-Channel radio w/4 servos

**Hobbico® Avistar™ 40 MkII AWARF® (HCAA2016)**

The Avistar 40 MkII gives pilots who have already mastered trainers an easy way to move up. Its semi-symmetrical airfoil offers the agility needed to experiment with basic aerobatics, while its high-wing design provides the in-flight stability and predictable handling of a trainer.

Almost all of the assembly work is done for you. Major sections are professionally factory-built of wood for strength and easy repairability, then skillfully covered in Top Flite® MonoKote® - the world's #1 film covering! You can be flying just 15-20 hours after you open the box. An extensive package of Great Planes-brand hardware - including a fuel tank, engine mount, spinner, wheels and pushrods - is not only included but largely installed for your convenience. Photo-illustrated instructions pave the way for rapid progress through the last few assembly steps to that fantastic first flight!

*If you don't have a lot of time to spare, Hobbico also offers the Avistar 40 Select. You can complete ALL assembly within 20 minutes, using a screwdriver and pliers. Hobbico has already installed a 4-channel Futaba® 4VF radio system and mounted a powerful O.S.® .40 LA engine in the nose, with the fuel tank and lines in place and connected. And that's not all: the preassembled, all-wood fuselage, wing halves and tail fins come skillfully precovered in MonoKote® film. (HCAA16\*\*)*



**Hobbico® TorqMaster™ 90 Starter (HCAP3200)**

With an easy press, you unleash enough torque to start engines up to .90 cu. in. Features aluminum cone, silicone insert, 5', self-coiling cord w/alligator clips and a 2-year warranty.



**Hobbico® Ultra-Tote™ ARH (Almost Ready to Haul) Field Box (HCAP5025)**

If your plane comes almost ready-to-fly, why shouldn't your field box come ready to use, too? Prebuilt and prepainted, the sturdy plywood Ultra-Tote ARH can be put together quickly using just a screwdriver. With its large drawer, cradle, 12V battery compartment and one-gallon fuel jug shelf, It can hold all the gear you need for a full day of flying. Painted yellow; field equipment and decal shown not included.



**Top Flite® Power Point® Wood Propellers (TOPQ5000-5200)**

- Lighter, quieter, and more efficient than ever!
- More thrust for greater power.
- Swept tip design reduces noise.

The strict quality control used when manufacturing Power Point props ensures symmetric pitch: at any given point on one blade, the pitch will exactly match the pitch at the same point on the opposite blade. This accuracy reduces prop vibration and boosts thrust at any rpm. Combined with a new airfoil design and the "Power Point" tip, these props are a top choice for modelers of every skill level. Lighter than maple props of the same size, these fuelproofed beechwood props reduce rotational mass, letting your engine produce more power with less work. Wood construction also makes Power Point props stiffer than nylon, so they perform predictably throughout the full rpm range.

This model belongs to:

---

Name

---

Address

---

City, State Zip

---

Phone number

---

AMA number

