

Gee Bee

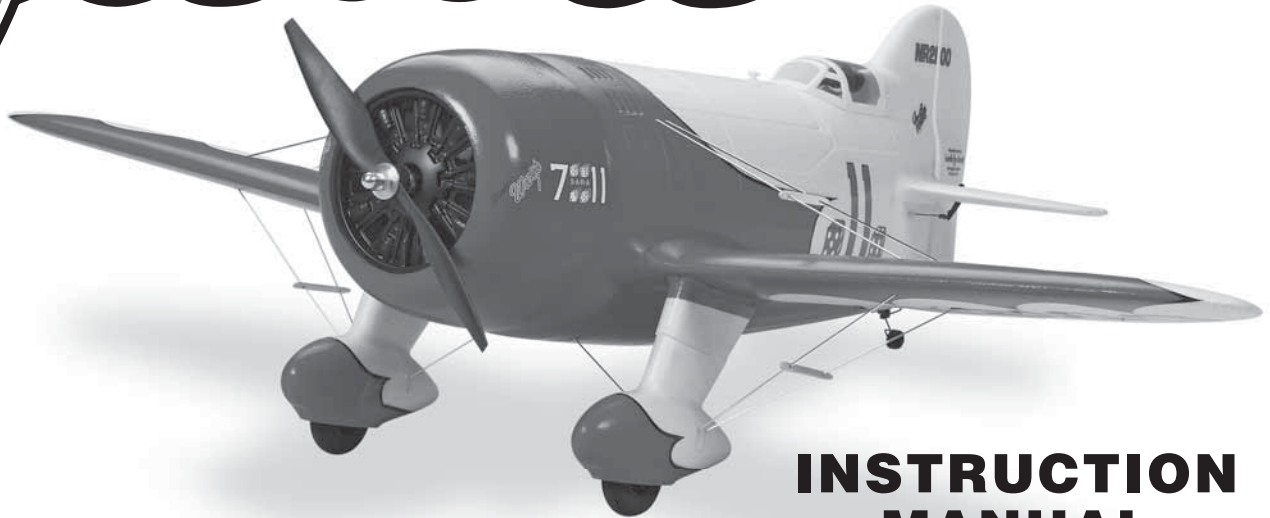

INSTRUCTION MANUAL

SPECIFICATIONS

Wingspan: 38.5 in [980 mm]

Wing Area: 241 in² [15.5 dm²]

Wing Loading: 16.7–19.1 oz/ft² [51–58 g/dm²]

Length: 27 in [685 mm]

Weight: 1.75–2 lb
[790–910 g]

Radio: 4-channel

Motor: Included

WARRANTY

Great Planes Model Manufacturing® Co. guarantees this kit to be free from defects in both material and workmanship at the date of purchase. This warranty does not cover any component parts damaged by use or modification. **In no case shall Great Planes' liability exceed the original cost of the purchased kit.** Further, Great Planes reserves the right to change or modify this warranty without notice.

In that Great Planes has no control over the final assembly or material used for final assembly, no liability shall be assumed nor accepted for any damage resulting from the use by the user of the final user-assembled product. By the act of using the user-assembled product, the user accepts all resulting liability.

If the buyer is not prepared to accept the liability associated with the use of this product, the buyer is advised to return

this kit immediately in new and unused condition to the place of purchase.

To make a warranty claim send the defective part or item to Hobby Services at the address below:

Hobby Services

3002 N. Apollo Dr. Suite 1
Champaign IL 61822 USA

Include a letter stating your name, return shipping address, as much contact information as possible (daytime telephone number, fax number, e-mail address), a detailed description of the problem and a photocopy of the purchase receipt. Upon receipt of the package the problem will be evaluated as quickly as possible.

READ THROUGH THIS MANUAL BEFORE STARTING CONSTRUCTION. IT CONTAINS IMPORTANT INSTRUCTIONS AND WARNINGS CONCERNING THE ASSEMBLY AND USE OF THIS MODEL.



Champaign, Illinois
(217) 398-8970, Ext 5
airsupport@greatplanes.com

TABLE OF CONTENTS

INTRODUCTION	2	BALANCE THE MODEL (C.G.)	10
Academy of Model Aeronautics	2	Balance the Model Laterally	11
SAFETY PRECAUTIONS	2	PREFLIGHT	12
DECISIONS YOU MUST MAKE	3	Identify Your Model	12
Recommended Batteries	3	Charge the Batteries	12
Radio	3	Balance Propellers	12
Recommended Charger	3	Ground Check and Range Check	12
Optional Replacement Prop.	3	MOTOR & BATTERY SAFETY PRECAUTIONS	12
ADDITIONAL ITEMS REQUIRED	3	LITHIUM BATTERY HANDLING & USAGE	12
Adhesives and Building Supplies	3	AMA SAFETY CODE EXCERPTS	13
Optional Supplies and Tools	3	General	13
KIT INSPECTION	3	Radio Control	13
ORDERING REPLACEMENT PARTS	4	CHECK LIST	13
KIT CONTENTS	4	FLYING	14
HORIZONTAL STABILIZER INSTALLATION	5	Takeoff	14
INSTALL THE MAIN LANDING GEAR	6	Flight	14
RADIO SETUP	6	Landing	14
INSTALLATION OF THE FLYING WIRES	9		

INTRODUCTION

Originally built by the Granville Brothers Aircraft of Springfield, Massachusetts in 1932, the Gee Bee R1 won the Thompson Trophy race that same year. It also set a new landplane world speed record of 296mph (476 km/h) in the Shell Speed Dash. But, the Gee Bee R1 quickly gained a reputation for being difficult to fly and dangerous. The Great Planes Gee Bee EP Rx-R has been designed to eliminate the dangerous flight characteristics, creating an easy to fly, great looking, sport plane.

For the latest technical updates or manual corrections to the Gee Bee EP Rx-R visit the Great Planes web site at www.greatplanes.com. Open the "Airplanes" link, then select the Gee Bee EP Rx-R. If there is new technical information or changes to this model a "tech notice" box will appear in the upper left corner of the page.

Academy of Model Aeronautics

If you are not already a member of the AMA, please join! The AMA is the governing body of model aviation and membership provides liability insurance coverage, protects modelers' rights and interests and is required to fly at most R/C sites.

Academy of Model Aeronautics

5151 East Memorial Drive
Muncie, IN 47302-9252

Tele. (800) 435-9262

Fax (765) 741-0057

Or via the Internet at: <http://www.modelaircraft.org>

IMPORTANT!!! Two of the most important things you can do to preserve the radio controlled aircraft hobby are to avoid flying near full-scale aircraft and avoid flying near or over groups of people.

SAFETY PRECAUTIONS

Protect Your Model, Yourself & Others... Follow These Important Safety Precautions

1. Your Gee Bee EP Rx-R should not be considered a toy, but rather a sophisticated, working model that functions very much like a full-size airplane. Because of its performance capabilities, the Gee Bee Rx-R, if not assembled and operated correctly, could possibly cause injury to yourself or spectators and damage to property.
2. You must assemble the model **according to the instructions**. Do not alter or modify the model, as doing so may result in an unsafe or unflyable model. In a few cases the instructions may differ slightly from the photos. In those instances the written instructions should be considered as correct.
3. You must take time to **build straight, true and strong**.
4. You must use an R/C radio system that is in good condition and other components as specified in this instruction manual. All components must be correctly installed so that the model operates correctly on the ground and in the air. You must check the operation of the model and all components before **every** flight.
5. If you are not an experienced pilot or have not flown this type of model before, we recommend that you get the assistance of an experienced pilot in your R/C club for your first flights. If you're not a member of a club, your local hobby shop has information about clubs in your area whose membership includes experienced pilots.
6. While this kit has been flight tested to exceed normal use, if the plane will be used for extremely high stress flying, such as racing, or if a motor is used that is stronger than the one included, the modeler is responsible for taking steps to reinforce the high stress points and/or substituting hardware more suitable for the increased stress.



We, as the kit manufacturer, provide you with a top quality, thoroughly tested kit and instructions, but ultimately the quality and flyability of your finished model depends on how you build it; therefore, we cannot in any way guarantee the performance of your completed model, and no representations are expressed or implied as to the performance or safety of your completed model.

Remember: Take your time and follow the instructions to end up with a well-built model that is straight and true.

DECISIONS YOU MUST MAKE

This is a partial list of items required to finish the Gee Bee EP Rx-R that may require planning or decision making before starting to build. Order numbers are provided in parentheses.

Recommended Batteries

A 2200mAh 11.1V LiPo battery pack is recommended.

- Great Planes ElectriFly® LiPo 11.1V 2200mAh 25C (GPMP0520)

OR

- FlightPower® EON-X™ 30 LiPo 11.1V 2200mAh 30C (FPWP6198)

Radio

The Gee Bee EP Rx-R requires a 4-channel transmitter and receiver.

Recommended Charger

A LiPo compatible charger is required to charge LiPo batteries. The Great Planes ElectriFly PolyCharge4™ is designed for LiPo battery packs only; however, it is able to charge four LiPo battery packs simultaneously. The ElectriFly Triton2™ and the AC/DC Triton2 EQ chargers will only charge one pack at a time, but are capable of charging NiCd, NiMH, Pb acid and LiPo batteries.

- Great Planes PolyCharge4 DC-Only 4 Output LiPo Charger (GPMM3015)

OR

- Great Planes ElectriFly Triton2 DC Computer Peak Charger (GPMM3153)

OR

- Great Planes AC/DC Triton2 EQ Charger/Balancer (GPMM3156)

Throughout the life of a LiPo battery, the individual cells located inside the battery pack may become unbalanced. These unbalanced cells can shorten the life of the battery or cause it to malfunction. For this reason, it is always recommended that a cell balancer be used when charging LiPo batteries.

The ElectriFly Equinox™ is a cell balancer that may be used with any LiPo charger and is capable of maintaining the cell balance of the battery pack. Note: the AC/DC Triton2 EQ does not require a cell balancer.

- Great Planes ElectriFly Equinox LiPo Cell Balancer (GPMM3160)

Optional Replacement Prop

- APC 10×7 Thin Electric Propeller (APCQ4123)

ADDITIONAL ITEMS REQUIRED

Adhesives and Building Supplies

This is the list of Adhesives and Building Supplies that are required to finish the Gee Bee EP Rx-R.

- Phillips Head Screw Driver
- Flat Blade Screw Driver
- Crescent Wrench
- Great Planes Pro CA+ Medium (GPMP6007)
- Great Planes CA Activator Foam Safe 2oz. Pump (GPMP6035)

Optional Supplies and Tools

Here is a list of optional tools mentioned in the manual that will help you build the Gee Bee EP Rx-R.

- CG Machine (GPMP2400)
- **Photos and sketches** are placed **before** the step they refer to. Frequently you can study photos in following steps to get another view of the same parts.
- The stabilizer and wing incidences and motor thrust angles have been factory-built into this model. However, some technically-minded modelers may wish to check these measurements anyway. To view this information visit the web site at www.greatplanes.com and click on "Technical Data." Due to manufacturing tolerances which will have little or no effect on the way your model will fly, please expect slight deviations between your model and the published values.

KIT INSPECTION

Before starting to build, inspect the parts to make sure they are of acceptable quality. If any parts are missing or are not of acceptable quality, or if you need assistance with assembly, contact **Product Support**. When reporting defective or missing parts, use the part names exactly as they are written in the manual.

Great Planes Product Support

3002 N Apollo Drive, Suite 1 Ph: (217) 398-8970, ext. 5
Champaign, IL 61822 Fax: (217) 398-7721

E-mail: airsupport@greatplanes.com

ORDERING REPLACEMENT PARTS

Replacement parts for the Great Planes Gee Bee EP Rx-R are available using the order numbers in the **Replacement Parts List** that follows. The fastest, most economical service can be provided by your hobby dealer or mail-order company.

To locate a hobby dealer, visit the Great Planes web site at www.greatplanes.com. Select "Where to Buy" in the menu across the top of the page and follow the instructions provided to locate a U.S., Canadian or International dealer.

Parts may also be ordered directly from Hobby Services by calling (217) 398-0007, or via facsimile at (217) 398-7721, but full retail prices and shipping and handling charges will apply. Illinois and Nevada residents will also be charged sales tax. If ordering via fax, include a Visa® or MasterCard® number and expiration date for payment.

Mail parts orders **Hobby Services**
and payments by 3002 N Apollo Drive, Suite 1
personal check to: Champaign IL 61822

Be certain to specify the order number exactly as listed in the **Replacement Parts List**. Payment by credit card or personal check only; no C.O.D.

If additional assistance is required for any reason contact Product Support by e-mail at productsupport@greatplanes.com, or by telephone at (217) 398-8970.

REPLACEMENT PARTS LIST	
Order No.	Description
GPMA3170	Fuselage
GPMA3171	Wing
GPMA3172	Tail Set
GPMA3173	Cowl
GPMA3174	Wheelpants
GPMA3175	Landing Gear Set
GPMA3176	Spinner Hub
GPMA3177	Propeller
GPMA3178	Hatch
GPMA3179	Wing Bolt 2 pcs.
GPMM1830	GP Silver Series 35A Brushless ESC 5V/2A BEC
GPMG2005	Brushless Motor 35 mm 1450 kV
GPMM5500	Servo 9G Micro

KIT CONTENTS

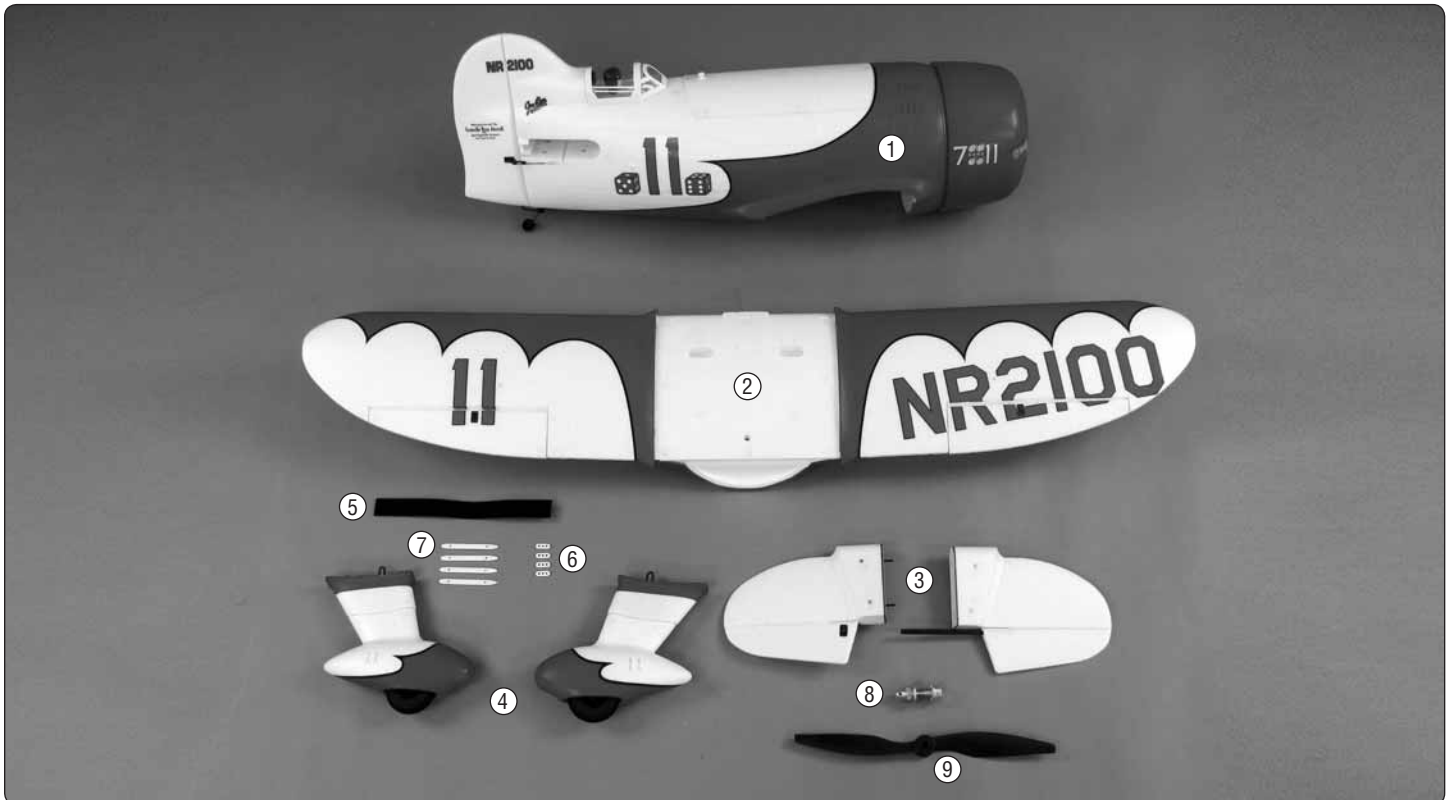

- | | | |
|---------------|---------------------------------|-----------------------------|
| 1. Fuselage | 4. Main Landing Gear and Covers | 7. Spreader Bar |
| 2. Wing | 5. Battery Strap | 8. Collet Type Prop Adapter |
| 3. Stabilizer | 6. Flying Wire Retainer | 9. Propeller |

HORIZONTAL STABILIZER INSTALLATION

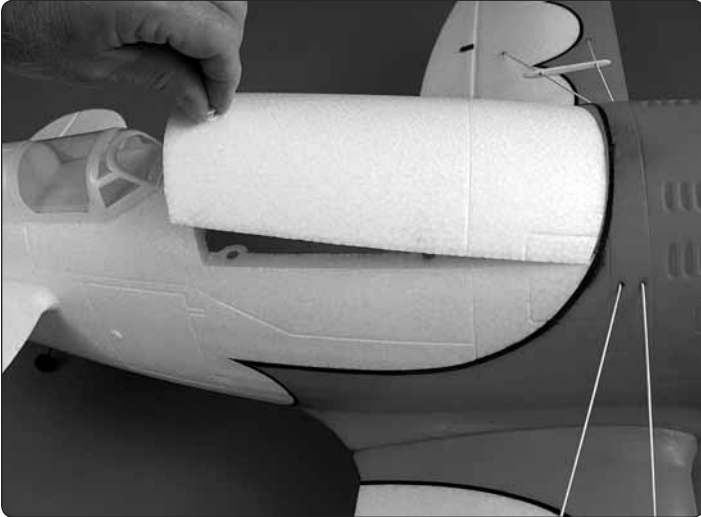

IMPORTANT: To remove the battery hatch cover, pull straight up on the knob at the aft end of the hatch cover. The magnets hold the hatch on well. It does require some force to lift the hatch.

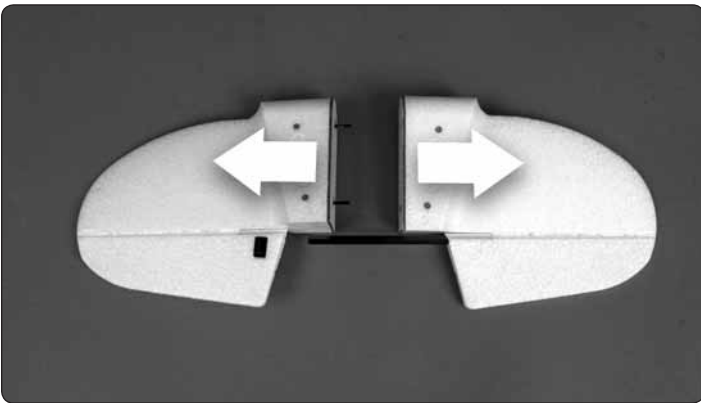

❑ 1. Separate the two stabilizer halves by carefully pulling them apart.

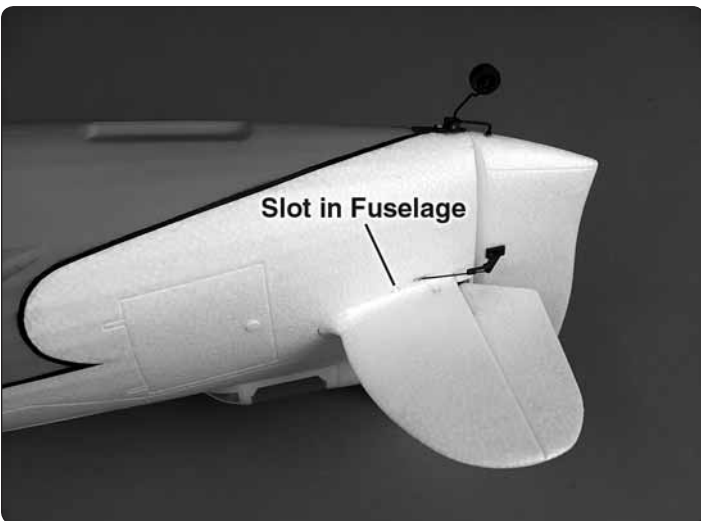

❑ 2. Insert the right stabilizer half into the fuselage. Note that the bottom of the stabilizer keys into the slot in the bottom of the opening.

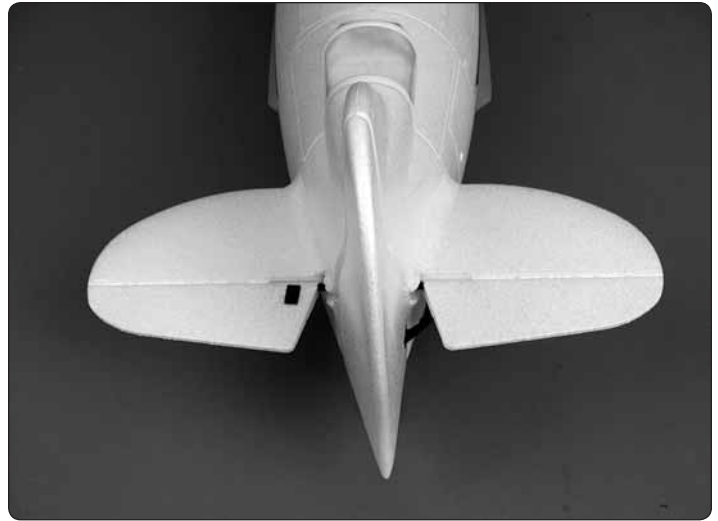

❑ 3. Carefully insert the left stabilizer into the fuselage. Align the elevator joiner with the hole in the elevator. Center the horizontal stabilizer in the fuselage.



❑ 4. Unclip the Faslink from the elevator pushrod. Insert the elevator pushrod in the middle hole of the elevator control horn and reinstall the Faslink.

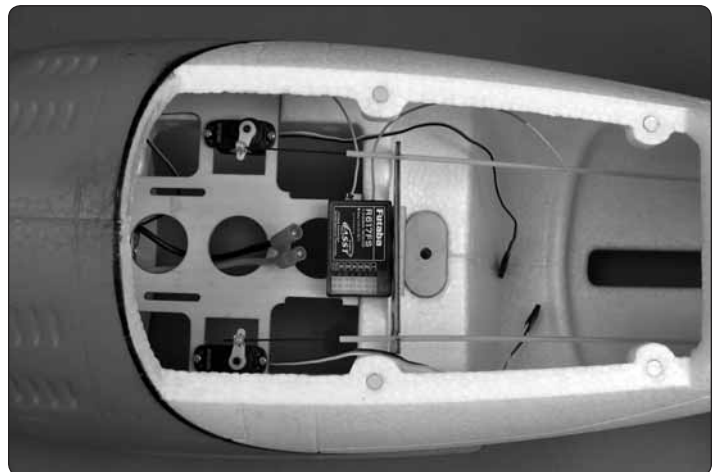

❑ 5. Attach a piece of double-sided tape to the back of your receiver. Remove the backing from the tape and attach the receiver to the top of the battery tray.

❑ 6. Plug the rudder and elevator servos and the ESC into the receiver.

INSTALL THE MAIN LANDING GEAR

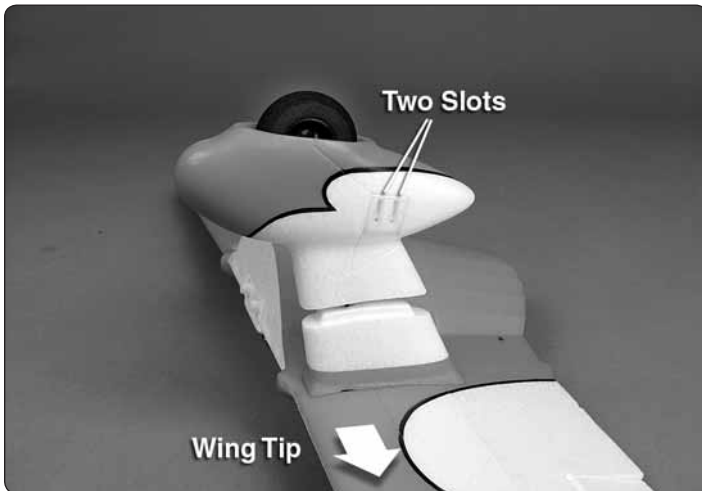

- □ 1. Set the right main landing gear wire in the plastic landing gear mount, in the wing. The two slots in the wheel pant go towards the wing tip.

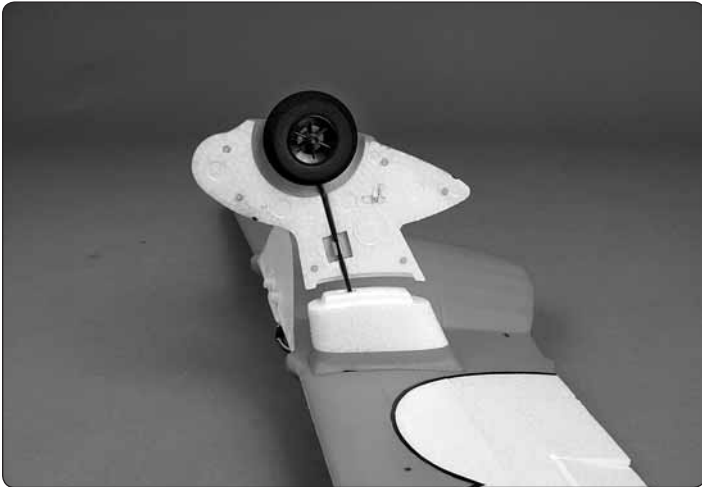

- □ 2. For better access to the main landing gear wire, carefully remove the outside of the wheel pant. The wheel pants are held together with magnets.

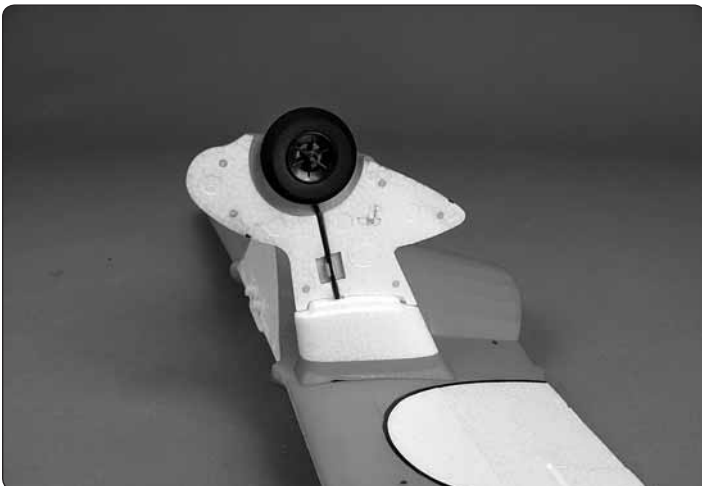

- □ 3. Press the main landing gear wire into the landing gear mounts.

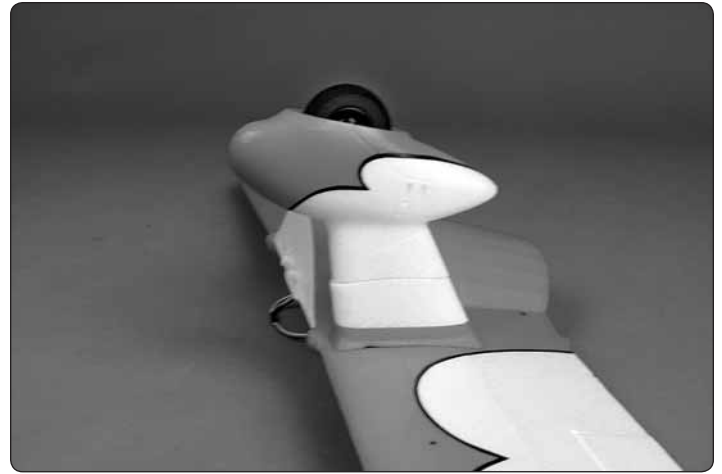

- □ 4. Re-install the outside wheel pant half.
- □ 5. Return to step 1 and install the left main gear.

RADIO SETUP

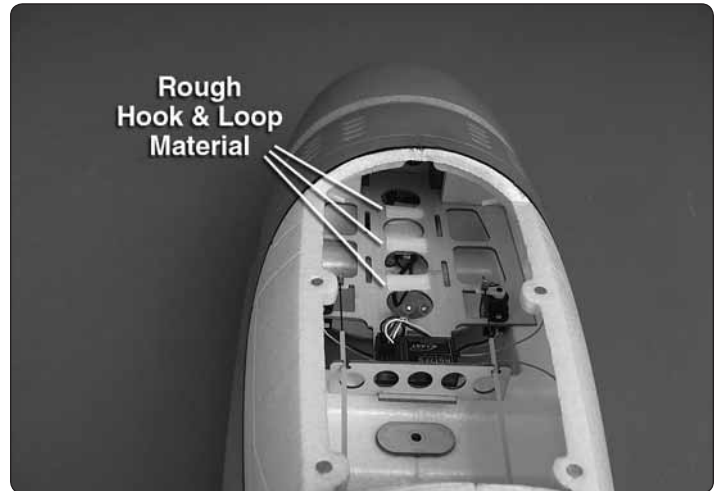

- □ 1. Cut three pieces of the rough side of the hook and loop material $\frac{1}{2}$ " [13mm] long. Attach each piece to the top of the battery tray between the lightening holes.



- □ 2. Insert the hook and loop battery strap through the slots at the front of the battery hatch opening.

- ❑ 3. Apply the soft side of the hook and loop material to the bottom of the motor battery. Insert the battery in the fuselage and secure it with the battery strap.

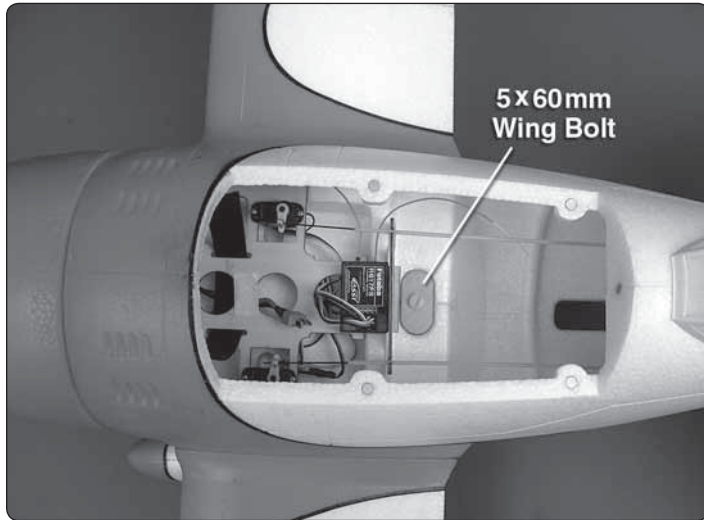

- ❑ 4. Install the wing and secure it with the nylon 5×60mm wing bolt.
- ❑ 5. Plug the aileron servos Y-harness into the receiver.

CAUTION: Perform the follow steps without the propeller installed.

- ❑ 6. Switch on your transmitter and then connect the motor battery to the ESC.

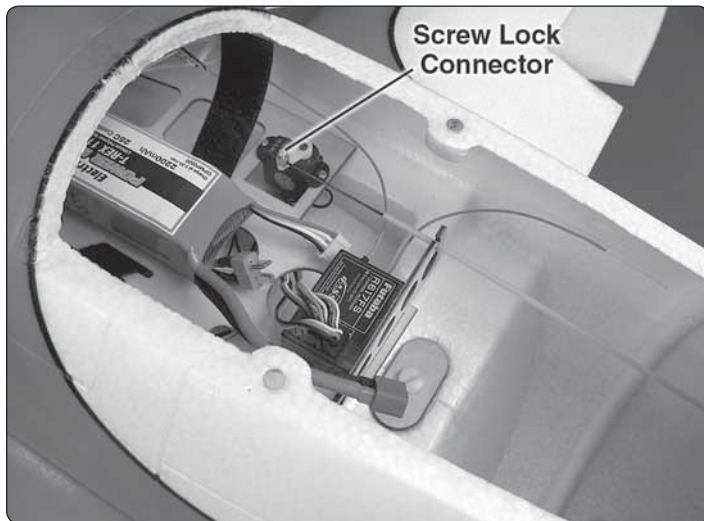

- ❑ 7. Adjust the trims on the transmitter so that they are centered. Center the elevator and rudder and tighten the screws in the brass screw lock connectors.

4-CHANNEL RADIO SETUP (STANDARD MODE 2)

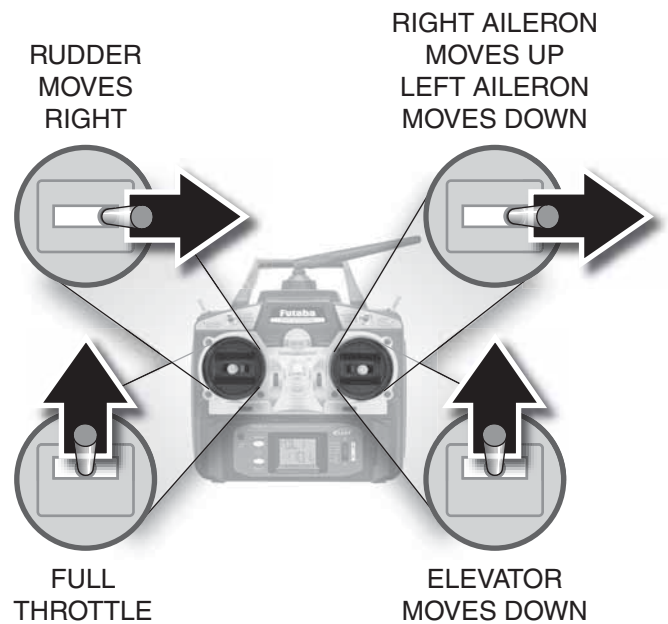

- ❑ 8. Check that all the control surfaces move in the correct direction. If not, reverse the controls on the transmitter.

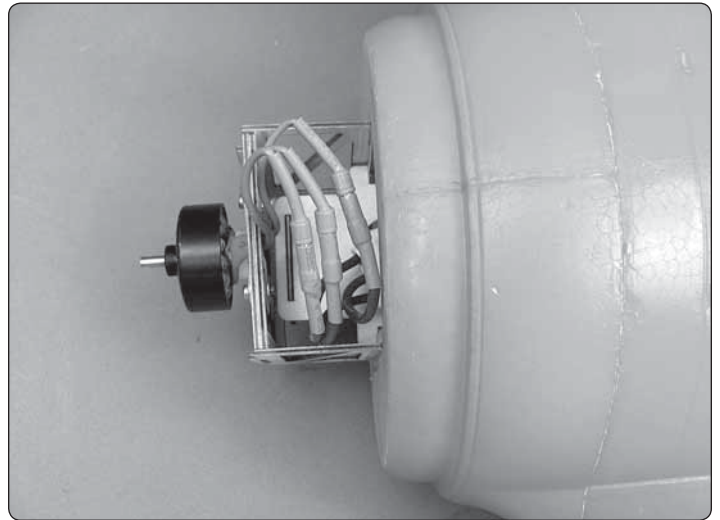

- ❑ 9. Check that the motor is rotating in the correct direction (counterclockwise when viewed from the front). If it is not, remove the cowl and switch two of the three motor wires.
- ❑ 10. Use a box or something similar to prop up the bottom of the fuselage so the horizontal stabilizer and wing are level.

Measure the **high rate** elevator throw first...

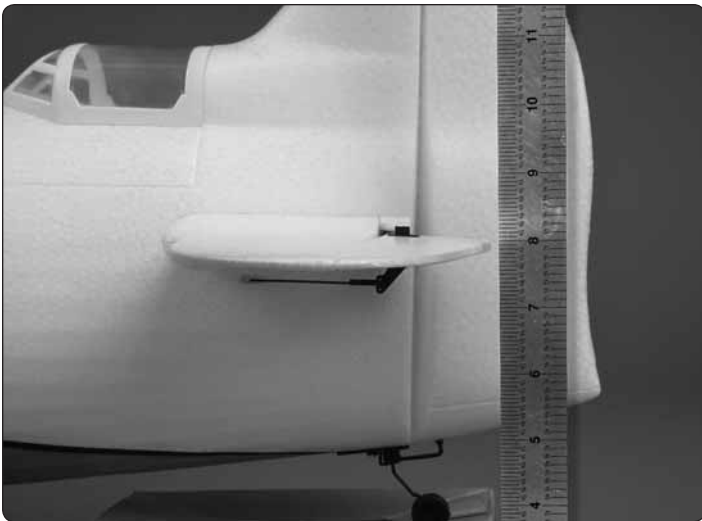

□ 11. Hold a ruler vertically on your workbench against the widest part (front to back) of the trailing edge of the elevator. Note the measurement on the ruler.

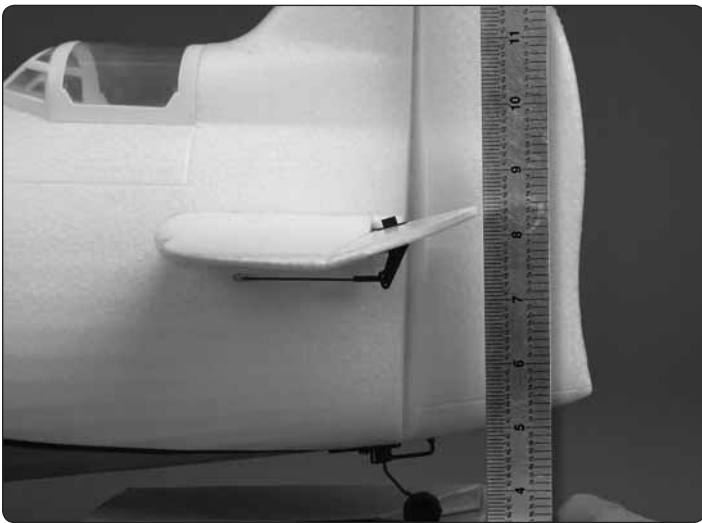

□ 12. Move the elevator up with your transmitter and move the ruler forward so it will remain contacting the trailing edge. The distance the elevator moves up from center is the “up” elevator throw. Measure the down elevator throw the same way.

□ 13. Depending on your radio, you may have to adjust the mechanical position of the pushrod linkage in order to achieve the proper throw. This is preferred to adjusting AFR, ATV or servo end points in the transmitter because it preserves the control resolution of the servo and allows for better control of the model.

These are the recommended control surface throws:

	LOW RATE		HIGH RATE	
	Up	Down	Up	Down
ELEVATOR	3/16" [5mm] 6°	3/16" [5mm] 6°	3/8" [10mm] 12°	3/8" [10mm] 12°
RUDDER	Right 1/2" [13mm] 10°	Left 1/2" [13mm] 10°	Right 3/4" [19mm] 15°	Left 3/4" [19mm] 15°
AILERONS	Up 1/2" [13mm] 14°	Down 1/2" [13mm] 14°	Up 3/4" [19mm] 21°	Down 3/4" [19mm] 21°

If your radio does not have dual rates, we recommend setting the throws at the low rate settings.

NOTE: The throws are measured at the **widest part** of the elevators, rudder and ailerons.

To ensure a successful first flight, set up your Gee Bee EP Rx-R according to the control throws specified in this manual. The throws have been determined through actual flight testing and accurate record-keeping, allowing the model to perform in the manner in which it was intended. After you have become accustomed to the way the Gee Bee EP Rx-R flies, you can adjust the amount of control throw to match your flying style. However, too much control throw could make the model too responsive and difficult to control, so remember, “more is not always better.”

INSTALLATION OF THE FLYING WIRES

(Optional)

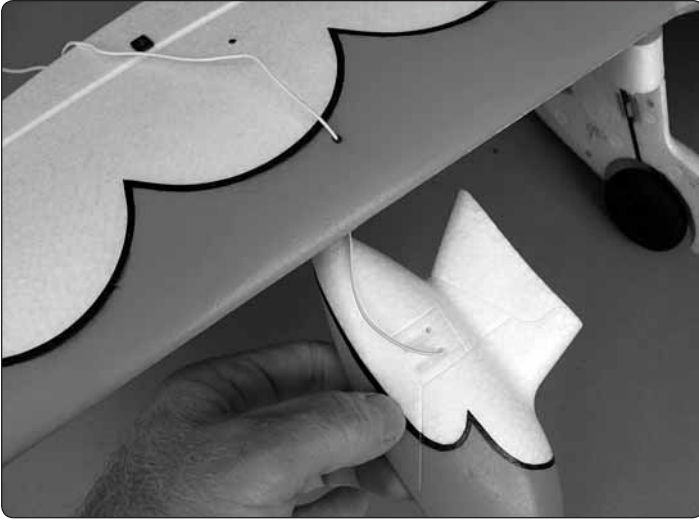

□ □ 1. Insert the elastic thread through the forward hole in the right wing and through the forward hole in the right outer wheel pant.

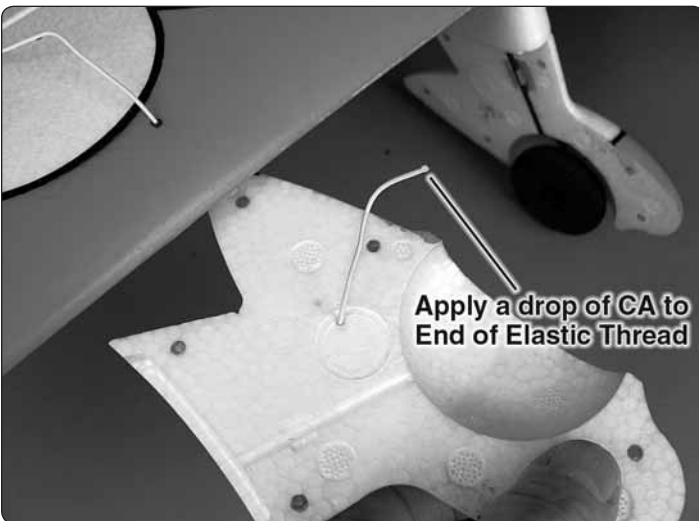

□ □ 2. Apply a drop of medium CA to the end of the elastic thread and pull the thread into the wheel pant so that the end of the thread is flush with the inside of the wheel pant. Wipe off any excess CA and spray the CA with Activator.

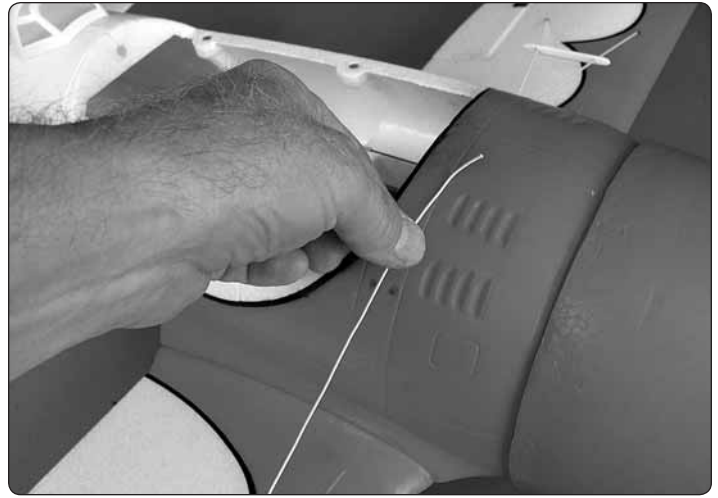

□ □ 3. Reattach the outer wheel pant to the inner wheel pant. Extend the elastic thread to the fuselage. Do not stretch the elastic. Cut the elastic thread, allowing a few inches extra for securing the thread inside the fuselage.

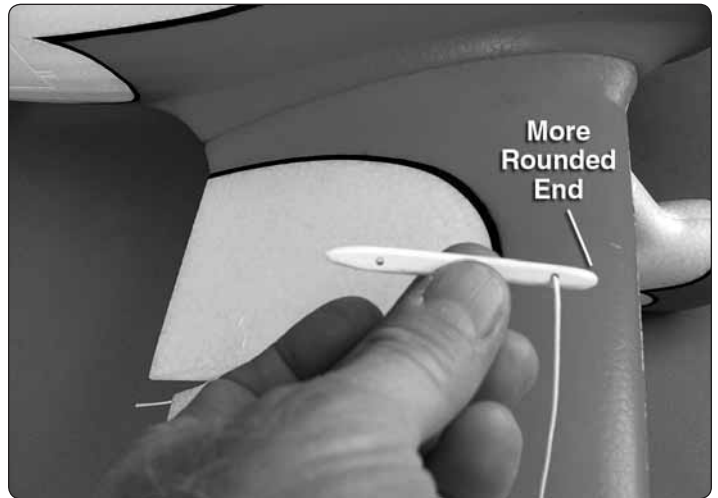

□ □ 4. Remove the thread from the wing and insert the elastic thread through the forward hole of the spreader bar, through the wing and through a second spreader bar. The forward end of the spreader bar is the more rounded end.



□ □ 5. Insert the elastic thread in the forward hole of the fuselage.



❑ ❑ 6. Pull the elastic thread through the fuselage. Pass the thread through the flying wire retainer as shown.

❑ ❑ 7. Follow the same procedure to install the aft flying wire.

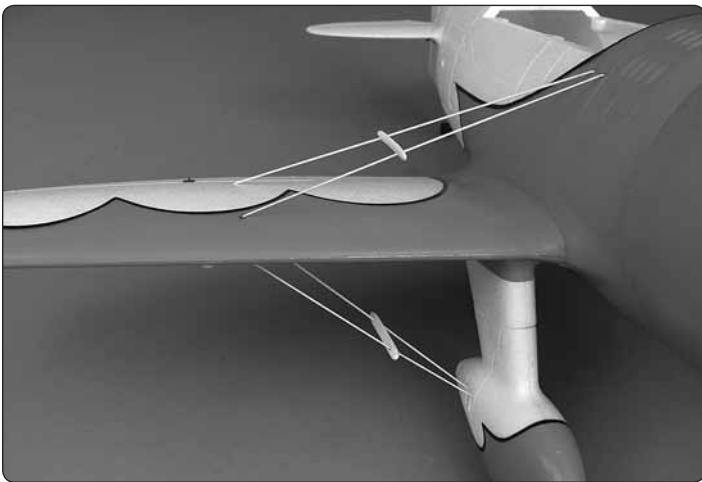

❑ ❑ 8. Adjust the tension on the flying wires so that there is no slack in the elastic thread. But, they need to be able to stretch if hit.

❑ ❑ 9. Position the spreader bars so that the flying wires are straight. Apply a drop of CA on the joint between the spreader bars and the flying wires to hold the spreader bars in place.

❑ 10. Return to step 1 and install the flying wires through the left wing.

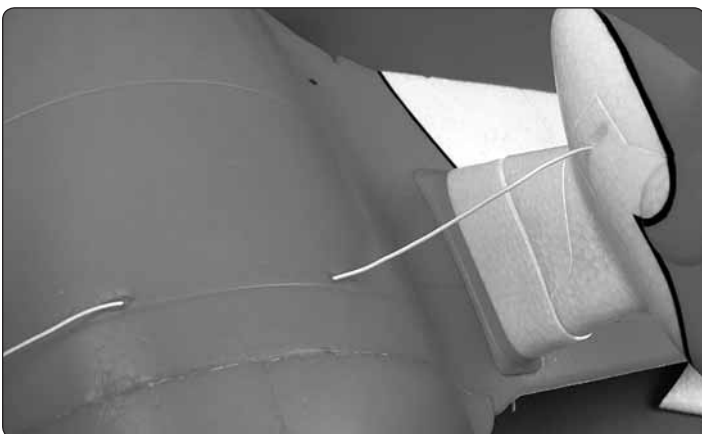

❑ 11. Pass the elastic thread through the two holes in the belly pan and through the hole in one of the inside wheel pants.

❑ 12. Glue the elastic thread to the wheel pant as before.

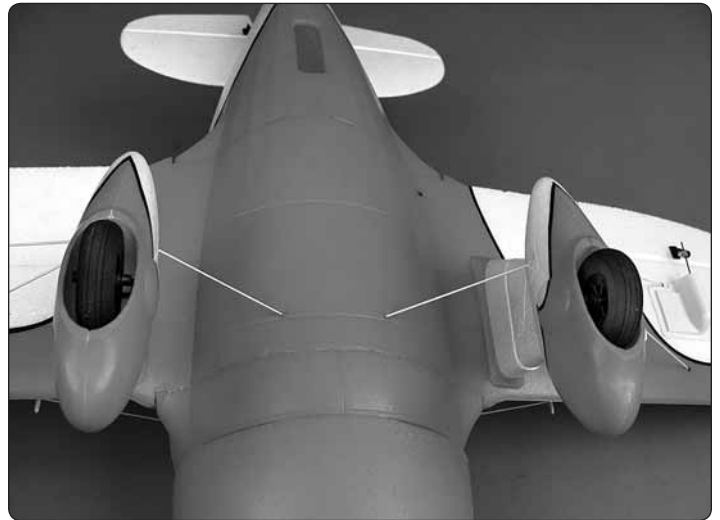

❑ 13. Cut the elastic thread a little long at the other wheel pant. Pass the thread through the wheel pant so that a slight amount of tension is on the thread. Apply a drop of CA to the thread. After the CA has hardened, trim the thread flush with the inside of the wheel pant.

BALANCE THE MODEL (C.G.)

CAUTION: Disconnect the motor battery and switch the transmitter off.



❑ 1. Slide the aluminum collet type prop adapter on the motor shaft.

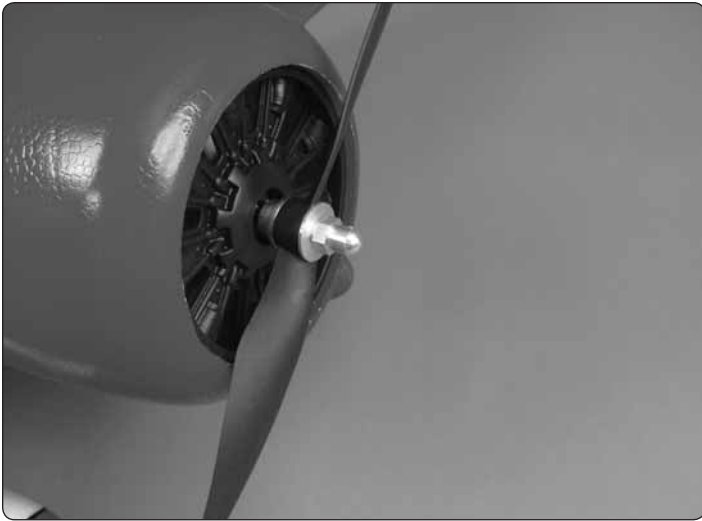

- ❑ 2. Install the propeller on the prop adapter and secure it with the prop washer and prop nut. Slowly rotate the propeller by hand to check that it does not hit the cowl. If it does, loosen the prop nut and slide the prop adapter forward slightly.

More than any other factor, the C.G. (center of gravity/ balance point) can have the greatest effect on how a model flies and could determine whether or not your first flight will be successful. If you value your model and wish to enjoy it for many flights, **DO NOT OVERLOOK THIS IMPORTANT PROCEDURE.** A model that is not properly balanced may be unstable and possibly unflyable.

At this stage the model should be in ready-to-fly condition with **all** of the components in place, including the motor battery.

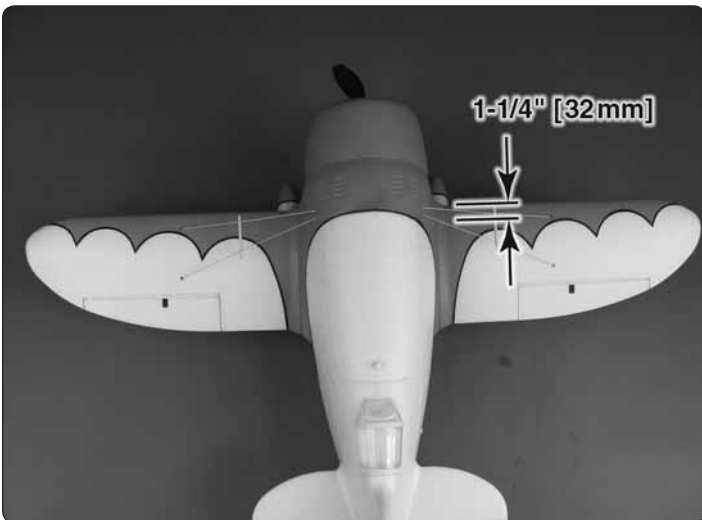

- ❑ 1. If using a Great Planes C.G. Machine™, set the rulers to 1-1/4" [32mm]. If not using a C.G. Machine, use a fine-point felt tip pen to place a small dot on the top of the wing on both sides of the fuselage 1-1/4" [32mm] back from the leading edge. Due to the Gee Bee having a short nose (and depending on the battery used), additional nose weight may be required.

This is where your model should balance for the first flights. Later, you may experiment by shifting the C.G. 5/32" [4mm] forward or 5/32" [4mm] back to change the flying characteristics. Moving the C.G. forward will improve the smoothness and stability, but the model will then be less aerobatic (which may be fine for less-experienced pilots). Moving the C.G. aft makes the model more maneuverable and aerobatic for experienced pilots. In any case, **start at the recommended balance point** and do not at any time balance the model outside the specified range.

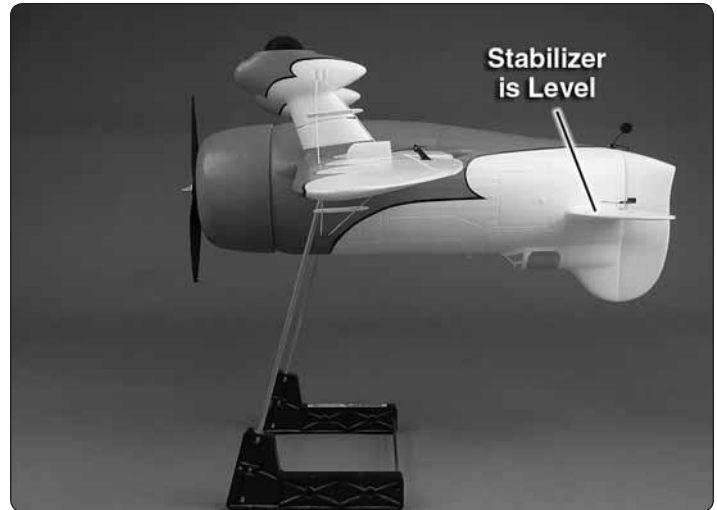

- ❑ 2. With the wing attached to the fuselage, all parts of the model installed (ready to fly) and the motor battery installed, place the model upside-down on a Great Planes CG Machine, or lift it upside-down at the balance point you marked.

- ❑ 3. If the tail drops, the model is "tail heavy." If possible, move the motor battery forward to get the model to balance. If the nose drops, the model is "nose heavy." If possible, move the motor battery aft. If moving the motor battery is not enough, use Great Planes "stick-on" lead (GPMQ4485). To find out how much weight is required, place incrementally increasing amounts of weight on the bottom of the fuselage over the location where it would be mounted inside until the model balances. A good place to add stick-on nose weight is to the motor box. Do not attach weight to the cowl—the magnets securing the cowl cannot support the additional weight. Once you have determined the amount of weight required, it can be permanently attached.

- ❑ 4. **IMPORTANT:** If you found it necessary to add any weight, recheck the C.G. after the weight has been installed.

Balance the Model Laterally

- ❑ 1. With the wing level, have an assistant help you lift the model by the engine propeller shaft and the bottom of the fuse under the TE of the fin. Do this several times.

- ❑ 2. If one wing always drops when you lift the model, it means that side is heavy. Balance the airplane by adding weight to the other wing tip. **An airplane that has been laterally balanced will track better in loops and other maneuvers.**

PREFLIGHT

Identify Your Model

No matter if you fly at an AMA sanctioned R/C club site or if you fly somewhere on your own, you should always have your name, address, telephone number and AMA number on or inside your model. It is **required** at all AMA R/C club flying sites and AMA sanctioned flying events. Fill out the identification tag on page 15 and place it on or inside your model.

Charge the Batteries

Follow the battery charging instructions that came with your radio control system to charge the batteries. You should always charge your transmitter batteries the night before you go flying, and at other times as recommended by the radio manufacturer.

CAUTION: Unless the instructions that came with your radio system state differently, the **initial** charge on **new** transmitter should be done for 15 hours **using the slow-charger that came with the radio system**. This will “condition” the batteries so that the next charge may be done using the fast-charger of your choice. If the initial charge is done with a fast-charger the batteries may not reach their full capacity and you may be flying with batteries that are only partially charged.

Balance Propellers

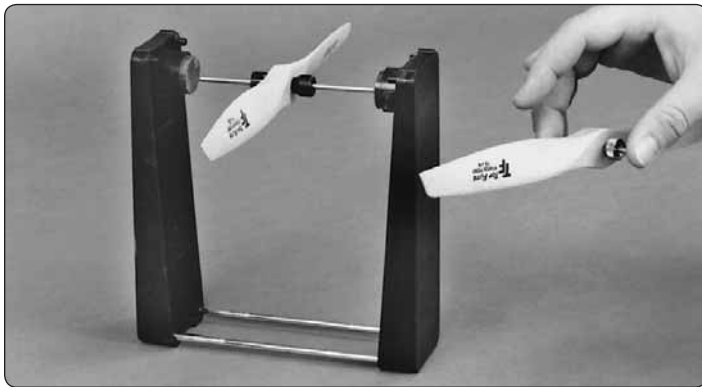

Carefully balance your propeller and spare propellers before you fly. An unbalanced prop can be the single most significant cause of vibration that can damage your model. Not only will motor mounting screws and bolts loosen, possibly with disastrous effect, but vibration may also damage your radio receiver and battery.

We use a Top Flite Precision Magnetic Prop Balancer (TOPQ5700) in the workshop and keep a Great Planes Fingertip Prop Balancer (GPMQ5000) in our flight box.

Ground Check and Range Check

Always ground check the operational range of your radio before the first flight of the day following the manufacturer's instructions that came with your radio. This should be done once with the motor off and once with the motor running at various speeds. If the control surfaces do not respond correctly, **do not fly!** Find and correct the problem first. Look for loose servo connections or broken wires, corroded wires on old servo connectors, poor solder joints in your battery pack or a defective cell, or a damaged receiver crystal from a previous crash. Make sure the receiver antennas are positioned as recommended in the radio instructions.

MOTOR & BATTERY SAFETY PRECAUTIONS

Failure to follow these safety precautions may result in severe injury to yourself and others.

Do not run the motor in an area of loose gravel or sand; the propeller may throw such material in your face or eyes.

Keep your face and body as well as all spectators away from the plane of rotation of the propeller while the motor is running.

Keep these items away from the prop: loose clothing, shirt sleeves, ties, scarfs, long hair or loose objects such as pencils or screwdrivers that may fall out of shirt or jacket pockets into the prop.

The motor gets hot! Do not touch it right after operation.

Once the motor battery is connected to the ESC, stay clear of the propeller. The motor could start at any time.

LITHIUM BATTERY HANDLING & USAGE

WARNING: Read the entire instruction sheet included with your battery. Failure to follow all instructions could cause permanent damage to the battery and its surroundings and cause bodily harm!

ONLY use a LiPo approved charger. **NEVER** use a NiCd/NiMH peak charger to charge a LiPo battery.

NEVER charge in excess of 4.20V per cell.

ONLY charge through the “charge” lead. **NEVER** charge through the “discharge” lead.

NEVER charge at currents greater than 1C unless the battery is rated for a higher charge rate.

ALWAYS set the charger's output volts to match the battery volts.

ALWAYS charge in a fireproof location.

NEVER trickle charge.

NEVER allow the battery temperature to exceed 150 degrees F (65 degrees C).

NEVER disassemble or modify the pack wiring in any way or puncture the cells.

NEVER discharge below 2.5V per cell.

NEVER place the battery or charger on combustible materials or leave it unattended during charge or discharge.

ALWAYS KEEP OUT OF THE REACH OF CHILDREN.

NEVER charge the battery in the plane.

ALWAYS remove the battery from the plane after a crash. Set it aside in a safe location for at least 20 minutes. If the battery is damaged in the crash it could catch fire.

If the battery starts to swell, quickly move the battery to a safe location, preferably outside. Place it in a bucket, covering the battery with sand. Never use water to try and put out a LiPo fire.

AMA SAFETY CODE EXCERPTS

Read and abide by the following excerpts from the Academy of Model Aeronautics Safety Code. For the complete Safety Code refer to *Model Aviation* magazine, the AMA web site or the Code that came with your AMA license.

General

1) I will not fly my model aircraft in sanctioned events, air shows, or model flying demonstrations until it has been proven to be airworthy by having been previously, successfully flight tested.

2) I will not fly my model aircraft higher than approximately 400 feet within 3 miles of an airport without notifying the airport operator. I will give right-of-way and avoid flying in the proximity of full-scale aircraft. Where necessary, an observer shall be utilized to supervise flying to avoid having models fly in the proximity of full-scale aircraft.

3) Where established, I will abide by the safety rules for the flying site I use, and I will not willfully and deliberately fly my models in a careless, reckless and/or dangerous manner.

5) I will not fly my model unless it is identified with my name and address or AMA number, on or in the model. Note: This does not apply to models while being flown indoors.

7) I will not operate models with pyrotechnics (any device that explodes, burns, or propels a projectile of any kind).

Radio Control

1) I will have completed a successful radio equipment ground check before the first flight of a new or repaired model.

2) I will not fly my model aircraft in the presence of spectators until I become a qualified flier, unless assisted by an experienced helper.

3) At all flying sites a straight or curved line(s) must be established in front of which all flying takes place with the

other side for spectators. Only personnel involved with flying the aircraft are allowed at or in the front of the flight line. Intentional flying behind the flight line is prohibited.

4) I will operate my model using only radio control frequencies currently allowed by the Federal Communications Commission.

5) **I will not knowingly operate my model within three miles of any pre-existing flying site except in accordance with the frequency sharing agreement listed** [in the complete AMA Safety Code].

9) Under no circumstances may a pilot or other person touch a powered model in flight; **nor should any part of the model other than the landing gear, intentionally touch the ground, except while landing.**

CHECK LIST

During the last few moments of preparation your mind may be elsewhere anticipating the excitement of the first flight. Because of this, you may be more likely to overlook certain checks and procedures that should be performed before the model is flown. To help avoid this, a check list is provided to make sure these important areas are not overlooked. Many are covered in the instruction manual, so where appropriate, refer to the manual for complete instructions. Be sure to check the items off as they are completed (that's why it's called a *check list!*).

- 1. Check the C.G. according to the measurements provided in the manual.
- 2. Be certain the motor battery and receiver are securely mounted in the fuse with hook and loop material.
- 3. Balance your model *laterally* as explained in the instructions.
- 4. Use threadlocking compound to secure critical fasteners such as the screws in the screw-lock pushrod connectors.
- 5. Add a drop of oil to the axles so the wheels will turn freely.
- 6. Confirm that all controls operate in the correct direction and the throws are set up according to the manual.
- 7. Make sure any servo wires do not interfere with other systems (servo arms, pushrods, etc.).
- 8. Balance your propeller (and spare propellers).
- 9. Tighten the propeller nut and spinner.
- 10. Place your name, address, AMA number and telephone number on or inside your model.
- 11. If you wish to photograph your model, do so before your first flight.
- 12. Range check your radio when you get to the flying field.

FLYING

The Gee Bee EP Rx-R is a great-flying model that flies smoothly and predictably. The Gee Bee EP Rx-R does not, however, possess the self-recovery characteristics of a primary R/C trainer and should be flown only by experienced R/C pilots.

CAUTION (THIS APPLIES TO ALL R/C AIRPLANES):

If, while flying, you notice an alarming or unusual sound such as a low-pitched “buzz,” this may indicate control surface *flutter*. Flutter occurs when a control surface (such as an aileron or elevator) or a flying surface (such as a wing or stab) rapidly vibrates up and down (thus causing the noise). In extreme cases, if not detected immediately, flutter can actually cause the control surface to detach or the flying surface to fail, thus causing loss of control followed by an impending crash. The best thing to do when flutter is detected is to slow the model **immediately** by reducing power, then land as soon as safely possible. Identify which surface fluttered (so the problem may be resolved) by checking all the servo grommets for deterioration or signs of vibration. Make certain all pushrod linkages are secure and free of play. If it fluttered once, under similar circumstances it will probably flutter again unless the problem is fixed. Some things which can cause flutter are; Excessive hinge gap; Not mounting control horns solidly; Poor fit of pushrod in horn; Side-play of wire pushrods caused by large bends; Excessive free play in servo gears; Insecure servo mounting; and one of the most prevalent causes of flutter; Flying an over-powered model at excessive speeds.

Takeoff

Before you get ready to takeoff, see how the model handles on the ground by doing a few practice runs at **low speeds** on the runway. Hold “up” elevator to keep the tail wheel on the ground. If necessary, adjust the tail wheel so the model will roll straight down the runway. The Gee Bee is very short coupled and can require a lot of rudder throw, especially when taking off in a cross wind. If you need to calm your nerves before the maiden flight, bring the model back into the pits. Top off the battery and check all fasteners and control linkages for peace of mind. We recommend setting a timer to limit the flight time and avoid a dead stick landing. Start with the timer set for 5-minutes. This should allow for a couple of landing attempts before the power starts to drop off.

Remember to takeoff into the wind. When you’re ready, point the model straight down the runway, hold a bit of up elevator to keep the tail on the ground to maintain tail wheel steering, then gradually advance the throttle. As the model gains speed decrease up elevator allowing the tail to come off the ground. One of the most important things to remember with a tail dragger is to always be ready to apply **right** rudder to counteract motor torque. Gain as much speed as your runway and flying site will practically allow before gently applying up elevator, lifting the model into the air. At this moment it is likely

that you will need to apply more right rudder to counteract motor torque. Be smooth on the elevator stick, allowing the model to establish a **gentle** climb to a safe altitude before turning into the traffic pattern.

Flight

For reassurance and to keep an eye on other traffic, it is a good idea to have an assistant on the flight line with you. Tell him to remind you to throttle back once the plane gets to a comfortable altitude. While full throttle is usually desirable for takeoff, most models fly more smoothly at reduced speeds.

Take it easy with the Gee Bee EP Rx-R for the first few flights, gradually getting acquainted with it as you gain confidence. Adjust the trims to maintain straight and level flight. The Gee Bee is a racing style plane but is capable of performing many basic sport plane maneuvers. After flying around for a while, and while still at a safe altitude with plenty of battery power remaining, practice slow flight and execute practice landing approaches by reducing the throttle to see how the model handles at slower speeds. Add power to see how she climbs as well. Continue to fly around, executing various maneuvers and making mental notes (or having your assistant write them down) of what trim or C.G. changes may be required to fine tune the model so it flies the way you like. Mind your flight time, but use this first flight to become familiar with your model before landing.

Landing

To initiate a landing approach, lower the throttle while on the downwind leg. Allow the nose of the model to pitch downward to gradually bleed off altitude. Continue to lose altitude, but maintain airspeed by keeping the nose down as you turn onto the crosswind leg. Make your final turn toward the runway (into the wind) keeping the nose down to maintain airspeed and control. The Gee Bee loses speed quickly, so adjust the throttle to keep the speed up. Level the attitude when the model reaches the runway threshold, modulating the throttle as necessary to maintain your glide path and airspeed. If you are going to overshoot, smoothly advance the throttle (always ready on the right rudder to counteract torque) and climb out to make another attempt. When you’re ready to make your landing flare and the model is a foot or so off the deck, smoothly increase up elevator until it gently touches down. Once the model is on the runway and has lost flying speed, hold up elevator to place the tail on the ground, regaining tail wheel control.

After the flight you can continue to run the motor until the ESC cut-off stops the motor. This additional time can be added to the 5-minutes on your timer. Remember to leave enough time for a couple attempts at landing. You do not want the power to drop just as you power up to go around for a second landing attempt.

One final note about flying your model. Have a goal or flight plan in mind for **every** flight. This can be learning a new

maneuver(s), improving a maneuver(s) you already know, or learning how the model behaves in certain conditions (such as on high or low rates). This is not necessarily to improve your skills (*though it is never a bad idea!*), but more importantly so you do not surprise yourself by impulsively attempting a maneuver and suddenly finding that you've run out of time, altitude or airspeed. Every maneuver should be deliberate, not impulsive. For example, if you're going to do a loop, check your altitude, mind the wind direction (anticipating rudder corrections that will be required to maintain heading), remember to throttle back at the top, and make certain you are on the desired rates (high/low rates). A flight plan greatly reduces the chances of crashing your model just because of poor planning and impulsive moves. **Remember to think.**

**Have a ball! But always stay in control
and fly in a safe manner.**

GOOD LUCK AND GREAT FLYING!

This model belongs to:

Name

Address

City, State, Zip

Phone Number

AMA Number

