

AVISTAR elite

INSTRUCTION MANUAL



RTF
READY-TO-FLY

SPECIFICATIONS

Wingspan: 62.5 in [1590 mm]	Weight: 6.5–7 lb [2950–3170 g]	Glow: .46–.55 cu in
Wing Area: 672 in ² [43.3 dm ²]	Length: 55 in [1395 mm]	Engine: [7.5–9 cc] two-stroke
Wing Loading: 22–24 oz/ft ² [67–73 g/dm ²]	Radio: 4-5 channels	Electric: RimFire .46 (42-60-800)
		Power: Outrunner Brushless

WARRANTY

Great Planes® Model Manufacturing Co. guarantees this kit to be free from defects in both material and workmanship at the date of purchase. This warranty does not cover any component parts damaged by use or modification. **In no case shall Great Planes' liability exceed the original cost of the purchased kit.** Further, Great Planes reserves the right to change or modify this warranty without notice.

In that Great Planes has no control over the final assembly or material used for final assembly, no liability shall be assumed nor accepted for any damage resulting from the use by the user of the final user-assembled product. By the act of using the user-assembled product, the user accepts all resulting liability.

If the buyer is not prepared to accept the liability associated with the use of this product, the buyer is advised to return

this kit immediately in new and unused condition to the place of purchase.

To make a warranty claim send the defective part or item to Hobby Services at the address below:

Hobby Services
3002 N. Apollo Dr. Suite 1
Champaign IL 61822 USA

Include a letter stating your name, return shipping address, as much contact information as possible (daytime telephone number, fax number, e-mail address), a detailed description of the problem and a photocopy of the purchase receipt. Upon receipt of the package the problem will be evaluated as quickly as possible.

READ THROUGH THIS MANUAL BEFORE STARTING CONSTRUCTION. IT CONTAINS IMPORTANT INSTRUCTIONS AND WARNINGS CONCERNING THE ASSEMBLY AND USE OF THIS MODEL.



Champaign, Illinois (217) 398-8970
E-mail: airsupport@greatplanes.com

TABLE OF CONTENTS

INTRODUCTION	2	PREFLIGHT	16
AMA	2	Identify Your Model	16
SAFETY PRECAUTIONS	3	Balance Propellers	16
ITEMS REQUIRED	3	Ground Check	16
Field Equipment	3	Range Check	16
Required Hardware & Accessories	3	ENGINE SAFETY PRECAUTIONS	16
Optional Flap Equipment	3	AMA SAFETY CODE EXCERPTS	17
Optional Supplies and Tools	4	General	17
Building Stand	4	Radio Control	17
IMPORTANT BUILDING NOTES	4	CHECK LIST	17
KIT INSPECTION	4	GATHER YOUR TOOLS	17
ORDERING REPLACEMENT PARTS	4	SPARE PARTS	18
CONTENTS	5	FUELING THE AVISTAR ELITE	18
PREPARATIONS	6	STARTING YOUR O.S. .46 AX II	18
ASSEMBLY	6	ADJUST THE NEEDLE VALVE	
Install the Propeller	8	AND BREAK IN THE ENGINE	18
Install the Wing	8	ADJUSTING THE MIXTURE CONTROL VALVE	19
Apply the Decals	9	FLYING	19
Optional Flaps	10	Taxiing	19
GET THE MODEL READY TO FLY	12	Takeoff	19
Check the Control Directions	12	Flight	20
Check the Throttle Operation	13	Landing	20
Check the Control Throws	14	MAINTENANCE TIPS	20
Balance the Model (C.G.)	15	Clean Up	20
Balance the Model Laterally	16	FINAL NOTE	20

INTRODUCTION

Congratulations on your purchase of the Hobbico Avistar Elite .46 RTF! This latest version of the popular Avistar is just what you need as a stepping stone from your flat-bottomed wing trainer, or is also suitable as a first plane with help from an instructor. The components of the Avistar Elite can be joined without the use of glue. The self-aligning, bolt-on tail and pre-hinged control surfaces speed up assembly time. The included IsoSmooth™ engine mount reduces engine vibration which could cause fuel to foam and parts to loosen over time. In addition, you will find other time-saving steps already completed for you such as the assembly of the fuel tank, flat spots ground into the axles for wheel collars, control horns pre-installed, etc. Once in the air, you'll find the Avistar to be a pleasure to fly and capable of performing basic aerobatics. The high wing design can fly well at only 1/2 throttle which will help new pilots learn the basics.

For the latest technical updates or manual corrections to the Avistar Elite visit the Hobbico web site at www.hobbico.com. Open the "Airplanes" link, then select the Avistar Elite RTF. If there is new technical information or changes to this model a "tech notice" box will appear in the upper left corner of the page.

AMA

IMPORTANT: Once mastered, piloting a model aircraft can be one of the most rewarding hobbies around. However, it cannot be stated strongly enough that, if you do not already know how to fly an R/C airplane, you will probably not be able to fly this model by yourself. It may appear to be easy, but over-controlling and disorientation quickly overcome inexperienced

fliers, swiftly ending their first flight. The best thing you can do to ensure success is to find a flight instructor who will inspect your model for airworthiness and provide flying lessons. If you haven't yet done so, contact the local hobby shop and ask them to introduce you to an instructor or an R/C club representative. If there is no club or experienced R/C pilot nearby, it would be worth even a long drive to find one-if only for just a few flight lessons (then you'll have an idea of what to expect). We urge you to join the AMA (Academy of Model Aeronautics) and a local R/C club. The AMA is the governing body of model aviation and membership is required to fly at AMA clubs. Though joining the AMA provides many benefits, one of the primary reasons to join is liability protection. Coverage is not limited to flying at contests or on the club field. It even applies to flying at public demonstrations and air shows. Failure to comply with the Safety Code (excerpts printed in the back of the manual) may endanger insurance coverage. Additionally, training programs and instructors are available at AMA club sites to help you get started the right way. There are over 2,500 AMA chartered clubs across the country. Contact the AMA at the address or toll-free phone number below:

Academy of Model Aeronautics

5151 East Memorial Drive
Muncie, IN 47302-9252

Tele. (800) 435-9262

Fax (765) 741-0057



Or via the Internet at: <http://www.modelaircraft.org>

IMPORTANT!!! Two of the most important things you can do to preserve the radio controlled aircraft hobby are to avoid flying near full-scale aircraft and avoid flying near or over groups of people.

SAFETY PRECAUTIONS

PROTECT YOUR MODEL, YOURSELF & OTHERS... FOLLOW THESE IMPORTANT SAFETY PRECAUTIONS

1. Your Avistar Elite should not be considered a toy, but rather a sophisticated, working model that functions very much like a full-size airplane. Because of its performance capabilities, the Avistar, if not assembled and operated correctly, could possibly cause injury to yourself or spectators and damage to property.
2. You must assemble the model **according to the instructions**. Do not alter or modify the model, as doing so may result in an unsafe or unflyable model. In a few cases the instructions may differ slightly from the photos. In those instances the written instructions should be considered as correct.
3. You must take time to **build straight, true and strong**.
4. You must correctly install all R/C and other components so that the model operates correctly on the ground and in the air.
5. You must check the operation of the model before **every** flight to insure that all equipment is operating and that the model has remained structurally sound. Be sure to check clevises or other connectors often and replace them if they show any signs of wear or fatigue.
6. If you are not an experienced pilot or have not flown this type of model before, we recommend that you get the assistance of an experienced pilot in your R/C club for your first flights. If you're not a member of a club, your local hobby shop has information about clubs in your area whose membership includes experienced pilots.
7. While this kit has been flight tested to exceed normal use, if the plane will be used for extremely high stress flying, such as racing, or if an engine larger than one in the recommended range is used, the modeler is responsible for taking steps to reinforce the high stress points and/or substituting hardware more suitable for the increased stress.
8. **WARNING:** The optional cowl and wheel pants available separately for this kit are made of fiberglass, the fibers of which may cause eye, skin and respiratory tract irritation. Never blow into a part (wheel pant, cowl) to remove fiberglass dust, as the dust will blow back into your eyes. Always wear safety goggles, a particle mask and rubber gloves when grinding, drilling and sanding fiberglass parts. Vacuum the parts and the work area thoroughly after working with fiberglass parts.

We, as the kit manufacturer, provide you with a top quality, thoroughly tested kit and instructions, but ultimately the quality and flyability of your finished model depends on how you build it; therefore, we cannot in any way guarantee the performance of your completed model, and no representations are expressed or implied as to the performance or safety of your completed model.

Remember: Take your time and follow the instructions to end up with a well-built model that is straight and true.

ITEMS REQUIRED

Field Equipment



When ready to fly, you'll need some additional equipment to fuel the plane and start the engine. The most important items include an electric starter, 12 volt battery, or chicken stick, fuel pump (electric or hand-crank), fueling lines and fittings and a 1.5 volt glow plug igniter. Your flight instructor will probably let you share his equipment for a while, but eventually you'll need your own. Visit your local hobby dealer or see the Hobbico catalog for a full selection, descriptions and pricing. The Hobbico Ultra-Tote Field Box Complete Combo (HCAP5105) contains everything you need to start your engine, except fuel.

Required Hardware & Accessories

This is the list of hardware and accessories required to finish the Avistar Elite RTF. These items are only required if you plan to install optional flaps. Order numbers are provided in parentheses.

- Great Planes Pro™ CA Glue Thin 1/2 oz (GPMR6001)
- Revell® #1 Light Duty Economy Knife w/Blade & Safety Cap (RMXR6909)
- Drill bits: 1/16" [1.6mm], 5/64" [2mm]
- Felt-tip pen
- 3/32" [2.4mm] allen wrench

Optional Flap Equipment

If you plan to install the optional flaps, you will need to purchase two additional standard servos and a dual servo extension. Part numbers are provided below.

- Futaba® S3004 Standard Ball Bearing Servo (FUTM0004)
- Futaba Dual Servo Extension 6" J (FUTM4130)

Optional Supplies and Tools

Here is a list of optional supplies and tools that are useful for maintaining the Avistar Elite.

- CA applicator tips (HCAR3780)
- CA debonder (GPMR6039)
- Pro 6-minute epoxy (GPMR6045)
- Epoxy brushes (6, GPMR8060)
- Mixing sticks (50, GPMR8055)
- Mixing cups (GPMR8056)
- Curved-tip canopy scissors for trimming plastic parts (HCAR0667)
- Hobbico High Precision Diagonal Cutter 5" (HCAR0630)
- Pliers with wire cutter (HCAR0625)
- Robart Super Stand II (ROBP1402)
- 12" × 18" [300 × 460mm] Builder's Cutting Mat (HCAR0454)
- 18" × 24" [460 × 610mm] Builder's Cutting Mat (HCAR0455)
- 24" × 36" [460 × 910mm] Builder's Cutting Mat (HCAR0456)
- T.A. Emerald Performance Duster Compressed Air 10 oz (TAEC1060)
- Panel Line Pen (TOPQ2510)
- Servo horn drill (HCAR0698)
- Hobby Heat™ micro torch (HCAR0755)
- AccuThrow™ Deflection Gauge (GPMR2405)
- CG Machine™ (GPMR2400)
- Great Planes Clevis Installation Tool (GPMR8030)
- Great Planes 4-In-1 Installation Tool (GPMR8035)
- Precision Magnetic Prop Balancer (TOPQ5700)

Building Stand



A building stand or cradle comes in handy during the build. We use the Robart Super Stand II (ROBP1402) for all our projects in R&D.

IMPORTANT BUILDING NOTES

- **Photos and sketches** are placed **before** the step they refer to. Frequently you can study photos in following steps to get another view of the same parts.
- The Avistar Elite RTF is factory-covered with Top Flite® MonoKote® film. Should repairs ever be required, MonoKote can be patched with additional MonoKote purchased separately. MonoKote is packaged in six-foot rolls, but some hobby shops also sell it by the foot. If only a small piece of MonoKote is needed for a minor patch, perhaps a fellow modeler would give you some. MonoKote is applied with a model airplane covering iron, but in an emergency a regular iron could be used. A roll of MonoKote includes full instructions for application. Following are the colors used on this model and order numbers for six foot rolls.
 - Orange TOPQ0202 Royal Blue TOPQ0221
 - Missile Red TOPQ0201 Jet White TOPQ0204
- The stabilizer and wing incidences and engine thrust angles have been factory-built into this model. However, some technically-minded modelers may wish to check these measurements anyway. To view this information visit the web site at www.hobbico.com and click on "Technical Data." Due to manufacturing tolerances which will have little or no effect on the way your model will fly, please expect slight deviations between your model and the published values.

KIT INSPECTION

Before starting to build, take an inventory of this kit to make sure it is complete, and inspect the parts to make sure they are of acceptable quality. If any parts are missing or are not of acceptable quality, or if you need assistance with assembly, contact **Product Support**. When reporting defective or missing parts, use the part names exactly as they are written in the Kit Contents list on this page.

Hobbico Product Support
3002 N Apollo Drive Suite 1
Champaign, IL 61822

Ph: (217) 398-8970 ext. 5
Fax: (217) 398-7721

E-mail: airsupport@hobbico.com

ORDERING REPLACEMENT PARTS

Replacement parts for the Hobbico Avistar Elite RTF are available using the order numbers in the **Replacement Parts List** that follows. The fastest, most economical service can be provided by your hobby dealer or mail-order company.

To locate a hobby dealer, visit the Hobbico web site at www.hobbico.com. Choose "Where to Buy" at the bottom of the menu on the left side of the page. Follow the instructions provided on the page to locate a U.S., Canadian or International dealer.

Parts may also be ordered directly from Hobby Services by calling (217) 398-0007, or via facsimile at (217) 398-7721, but full retail prices and shipping and handling charges will apply. Illinois and Nevada residents will also be charged sales tax. If

ordering via fax, include a Visa® or MasterCard® number and expiration date for payment.

Mail parts orders **Hobby Services**
 and payments by 3002 N Apollo Drive, Suite 1
 personal check to: Champaign IL 61822

Be certain to specify the order number exactly as listed in the **Replacement Parts List**. Payment by credit card or personal check only; no C.O.D.

If additional assistance is required for any reason contact Product Support by e-mail at productsupport@hobbico.com, or by telephone at (217) 398-8970.

REPLACEMENT PARTS LIST	
Order No.	Description
GPMA4280	Wing Set
GPMA4281	Fuselage Set w/o Engine Mount

Order No.	Description
GPMA4282	Tail Surfaces Set
GPMA4283	Hatch
GPMA4284	Landing Gear Set
GPMA4285	Wing Joiner Tube
GPMA4286	Electric Motor Mount
GPMA4287	Propeller 12x5
GPMA4288	Fuel Tank
GPMA4289	Decals
HCAA3739	Engine Mount
HCAA3740	Isosmooth Engine Mount Parts
HCAA3748	Tail Mounting Screws (2)
GPMQ4522	2.5" Red Spinner
OSMG0548	.46 AXII ABL Engine
FUTM0004	Standard Servo

CONTENTS



Kit Contents

- | | | |
|---|---------------------------|----------------|
| 1. Fuselage | 5. Vertical Fins & Rudder | 10. Propeller |
| 2. Left Wing | 6. Main Landing Gear | 11. Spinner |
| 3. Right Wing | 7. Wing Joiner Tube | 12. Tail Bolts |
| 4. Horizontal Stabilizer
& Elevators | 8. Transmitter | 13. Wing Bolts |
| | 9. AA Batteries | |

PREPARATIONS

- ❑ 1. If you have not done so already, remove the major parts of the kit from the box and inspect for damage. If any parts are damaged or missing, contact Product Support at the address or telephone number listed in the “Kit Inspection” section on page 4.



- ❑ 2. During transit and storage, it is not uncommon for the MonoKote covering to develop some wrinkles. Although the covering is applied tight at the factory, humidity and temperature change may cause the wood structure of the plane's components to expand or contract which allows the covering to relax. Before you begin assembly, we recommend that any wrinkles in the covering be tightened using a covering iron with a covering sock on high heat. A covering iron can be purchased from your hobby retailer and will also be useful if you ever need to make repairs to the MonoKote covering in the future. When using the iron, apply pressure over sheeted areas to **thoroughly** bond the covering to the wood. Work gently around open structure (such as the area between the wing ribs) and allow the heat of the iron to shrink the covering until it is pulled drum tight.

ASSEMBLY

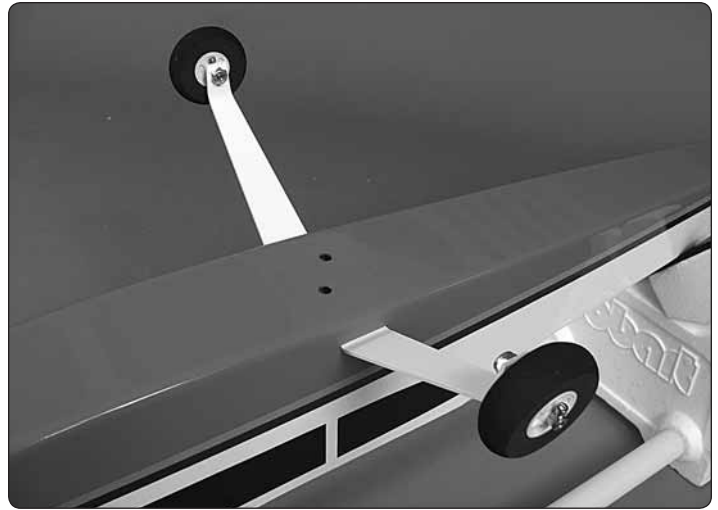
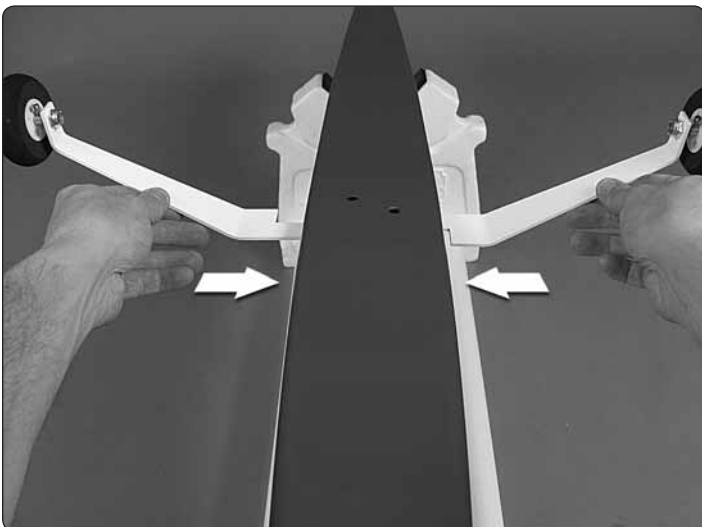

- ❑ 1. Fit the main landing gear legs into the slots in the fuselage. Push them in until the landing gear retaining mechanism inside the fuselage locks the gear in place. Pull on each leg to ensure they are secured in the fuselage.

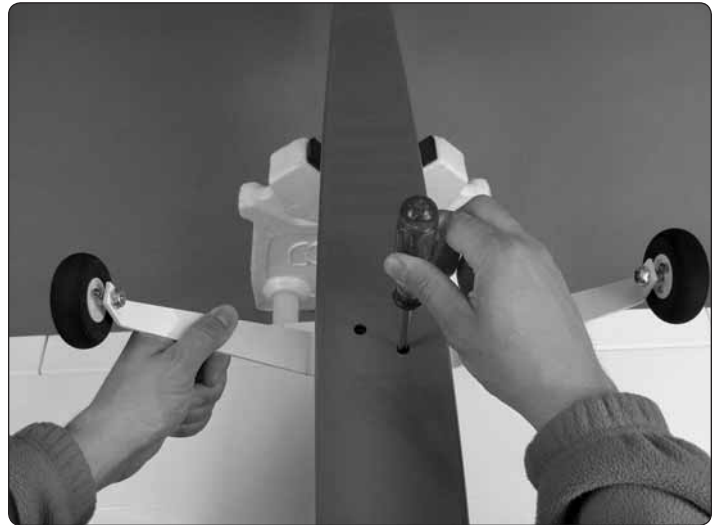

Note: Should you ever need to remove the landing gear from the fuselage, insert a screwdriver into the hole under the fuselage further from the leg you want to remove. Apply light pressure to the tab inside the hole and pull the landing gear leg out. Once the tab is moved, the screwdriver must be removed to allow the leg to come all the way out. Do the same with the other landing gear leg.

If your landing gear legs spread after a hard landing, remove the legs from the airplane and bend them back to the correct position with a vise. Do not try to straighten the legs while installed in the airplane as that may damage the SnapGear Landing Gear mechanism.

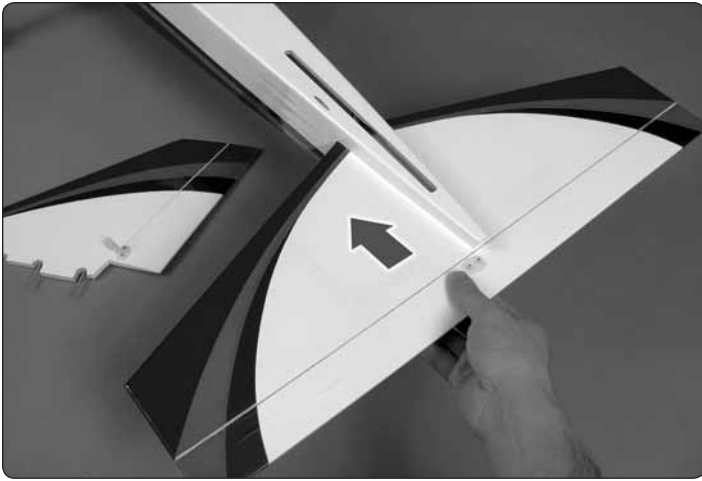

❑ 2. Slide the horizontal stabilizer into the stab slot in the aft end of the fuselage. Push it as far forward as it will fit. Center the stab in the slot. Look down through the vertical fin slot and ensure that the cutout in the horizontal stabilizer is aligned with the vertical fin slot.



❑ 3. Fit the vertical fin into the vertical fin slot. The metal posts in the fin should pass through the holes in the bottom of the fuselage.



❑ 4. Locate the two EasyAlign tail bolts. Slide them into the holes in the underside of the fuselage and onto the threaded metal posts. The bolts should be tightened snugly so the tail section is secure. Confirm that the horizontal stabilizer and vertical fin cannot shift in their slots. Take care not to over-tighten them as excessive force could damage the nylon threads and it may cause in-flight failure. **Do not over tighten these bolts.**

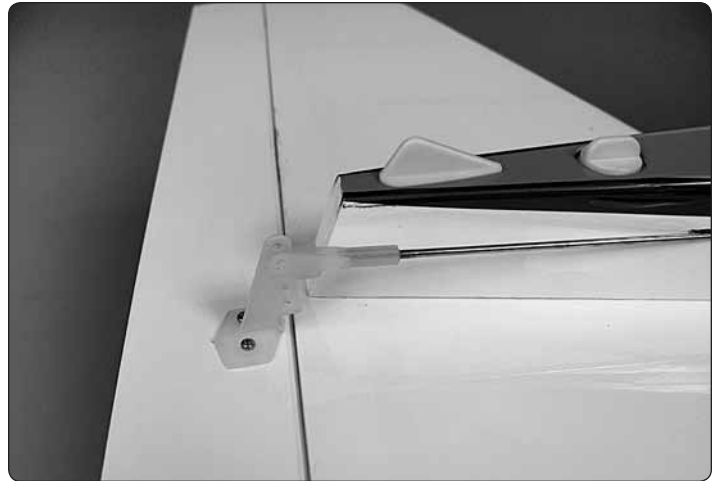

❑ 5. Connect the clevis on the elevator pushrod to the second from the outer hole in the elevator control horn. Slide the silicone clevis retainer to the end of the clevis.



❑ 6. Install the rudder clevis to the outer hole of the rudder control horn. Slide the silicone clevis retainer to the end of the clevis.



❑ 7. Unstrap the receiver battery holder from the receiver tray. Disconnect the receiver battery holder from the switch harness and remove it from the plane.



❑ 8. Install the included AA alkaline batteries into the receiver battery holder. Rewrap the the battery holder with the foam rubber and securely strap it in place next to the receiver. Reconnect the battery holder to the switch harness.

Install the Propeller

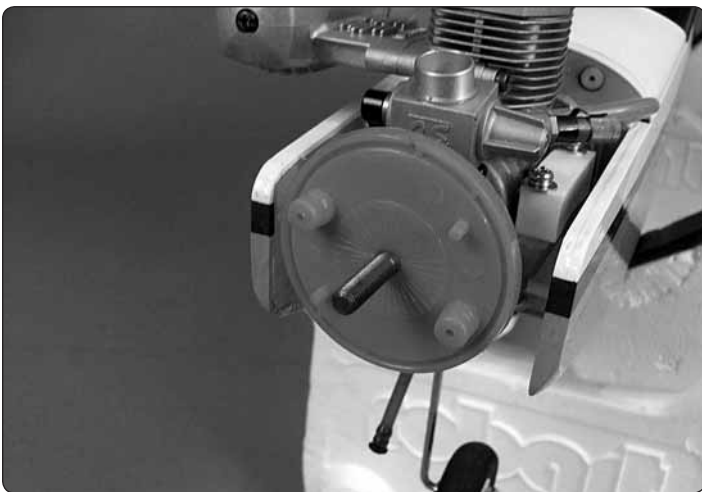

❑ 1. Slide the spinner backplate onto the engine crankshaft.

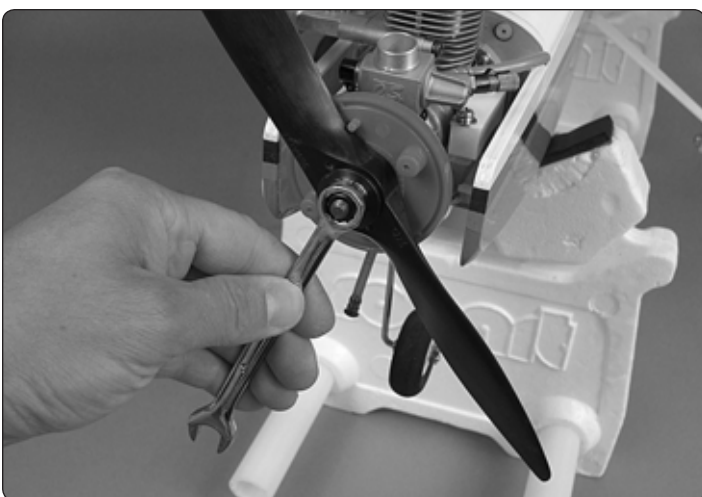

❑ 2. Align the propeller with the marks on the spinner backplate and then tighten the engine nut securely, using a 10 mm wrench or crescent wrench.



❑ 3. Fit the spinner cone to the back plate, then use a Phillips screwdriver to tighten the spinner screws snug but not over tight.

Install the Wing



❑ 1. Fit the servo leads in the wings through the holes in the underside of the wing panels.



❑ 2. Insert the aluminum wing joiner tube into one of the wing panels.

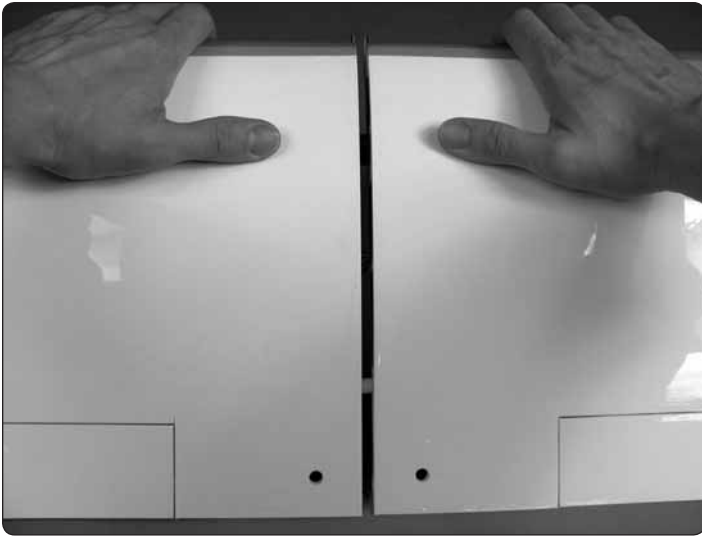

- ❑ 3. Slide the wing panels together onto the joiner tube.

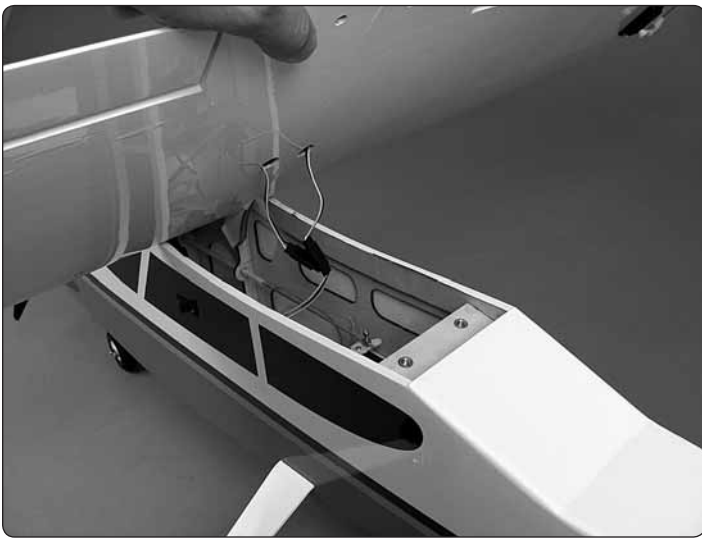

- ❑ 4. Connect the aileron (and flaps if applicable) servo leads to the Y-harness.



- ❑ 5. Fit the plywood wing root tabs into the slot in the fuselage.



- ❑ 6. Use the included 1/4-20 nylon wing bolts to secure the wing in place. The tool shown in the picture is a Great Planes 4-In-1 Installation Tool (GPMR8035 not included).



- ❑ 7. You are now completed with the assembly of your Avistar Elite. Continue with the final setup of your model.

Apply the Decals

- ❑ 1. Use scissors or a sharp hobby knife to cut the decals from the sheet.
- ❑ 2. Be certain the model is clean and free from oily fingerprints and dust. Prepare a dishpan or small bucket with a mixture of liquid dish soap and warm water—about one teaspoon of soap per gallon of water. Submerge the decal in the soap and water and peel off the paper backing. **Note:** Even though the decals have a “sticky-back” and are not the water transfer type, submersing them in soap & water allows accurate positioning and reduces air bubbles underneath.
- ❑ 3. Position decal on the model where desired. Holding the decal down, use a paper towel to wipe most of the water away.
- ❑ 4. Use a piece of soft balsa or something similar to squeegee remaining water from under the decal. Apply the rest of the decals the same way.

Optional Flaps

Installing flaps will require two additional standard servos. The addition of flaps will allow the plane to fly slower for takeoffs and landings. Note that the flaps are pinned in place during manufacturing and will not be able to move until they are cut free at the end of this assembly section.

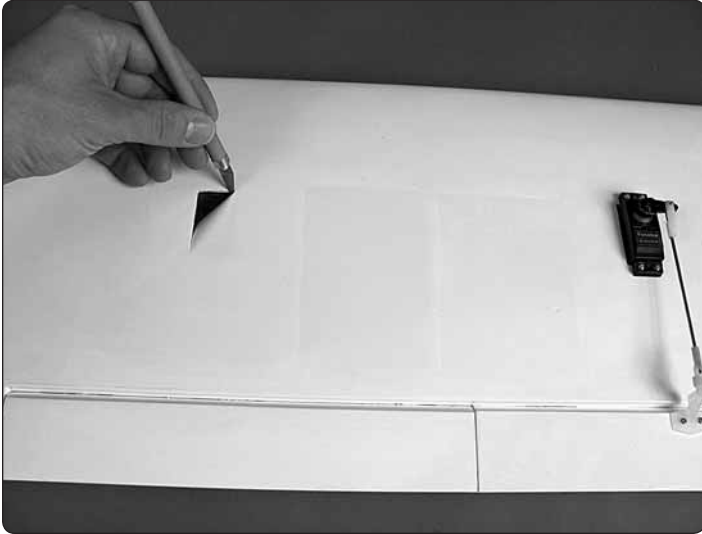

❑ 1. Locate the rectangular flap servo bays beneath the covering. If you cannot see them, look at the wing at a shallow angle or feel around the area shown in the picture and gently push in on the covering to locate the corners of the bays. Use a sharp hobby knife to trim the covering along the edges of the bays.

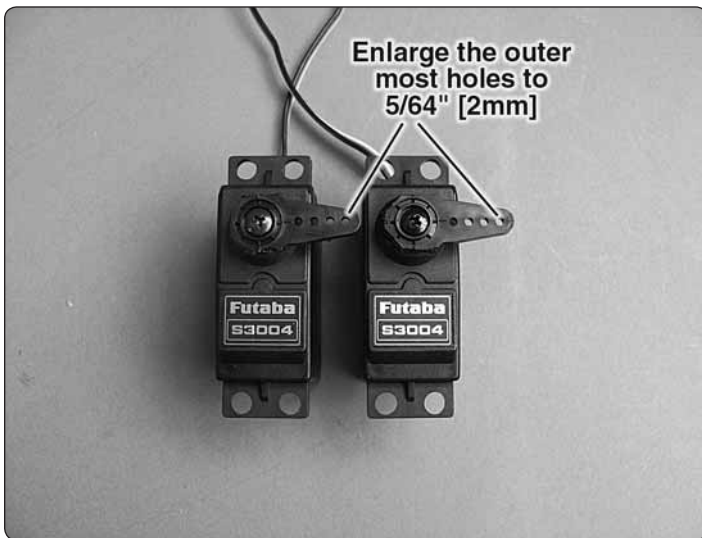

❑ 2. Temporarily connect each flap servo to the **aileron** channel on your receiver and use the radio system to center the servos. Install a four-armed servo arm onto each servo perpendicular to the servo cases and cut away the other three arms. **NOTE:** Unlike the aileron servos, the servo arms of the flap servos must both point in the **same direction**. Enlarge the outer most holes of each servo arm with a 5/64" [2mm] drill bit.

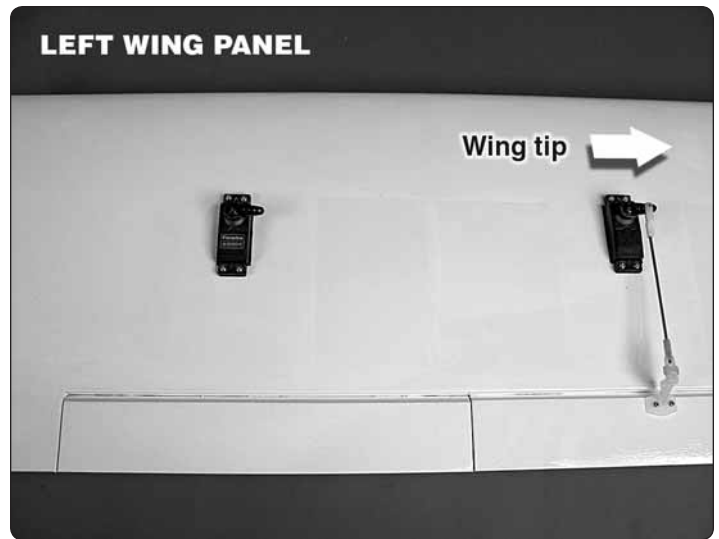

❑ 3. Install the rubber grommets and eyelets on the servos. Route the servo leads through the wing ribs and out the root ribs (the distance through the wing for the flap servo leads is shorter than the ailerons so using string to pull them through is not necessary). Fit the servos in place and drill the servo mounting holes using a 1/16" [1.6mm] drill bit. Apply a drop of thin CA to each hole. Then install the servos using the screws provided in the servo hardware bag. The servo arm of the left flap servo should point to the wing tip and the servo arm of the right flap servo should point to the wing root.



❑ 4. Now connect each flap servo to the **flap** channel on your radio and use the flap dial on your transmitter to rotate the servo arms toward the flaps as far as the radio will allow.

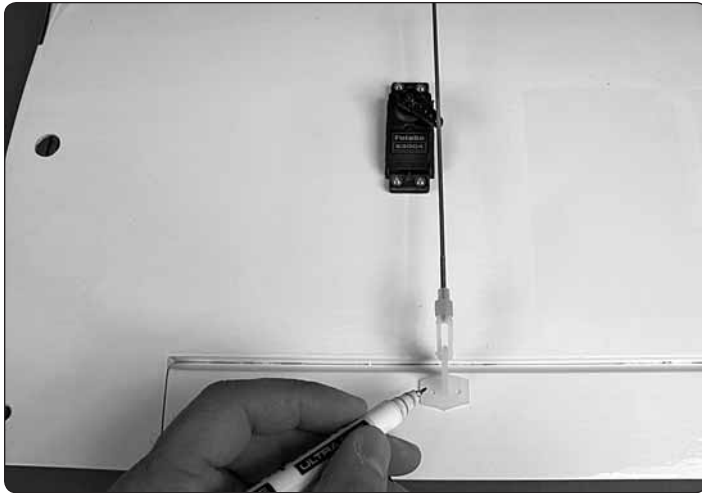
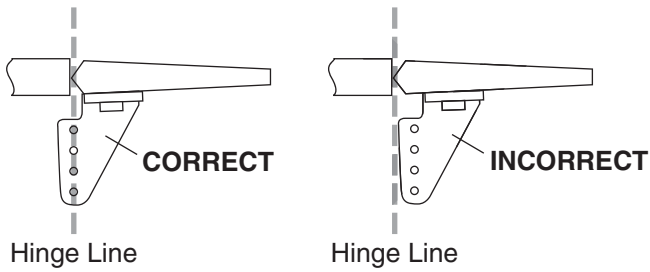

❑ 5. As you did with the aileron pushrods, install a clevis 20 complete turns onto two 6-1/4" [159 mm] pushrods and slide a silicone clevis retainer onto each clevis. Connect the clevises to the outer holes of two control horns. Hardwood plates are installed beneath the covering of the flaps for mounting the control horns. The edges of the plates can be seen by viewing the wing at a shallow angle. Position the control horns over the hardwood plates with the pushrods parallel to the servo cases and aligned over the outer holes of the servo arms. The holes in the control horns should be directly over the hinge line of the flaps. When satisfied with the position of the control horns, use a felt-tip pen to mark the location of the control horn mounting holes onto the flaps.

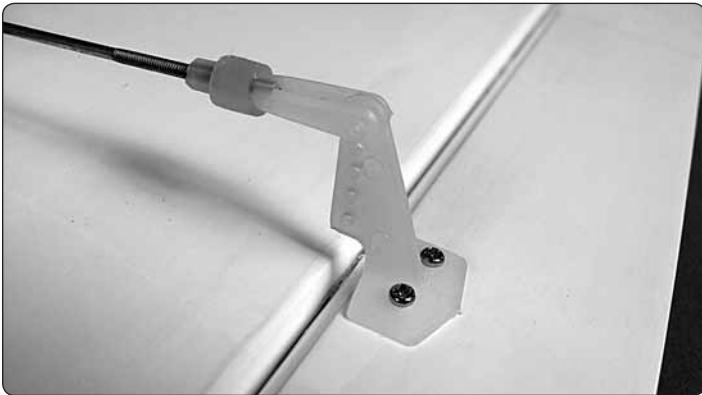

❑ 6. Drill 1/16" [1.6 mm] holes through the hardwood plates at the marks you made on the flaps. **Take care to only drill through the plates. Do not drill completely through the flaps!** The holes only need to be 3/8" [9.5 mm] deep. Thread a #2 x 3/8" [9.5 mm] self-tapping screw into each hole and back it out. Apply a drop or two of thin CA glue to each hole and allow the glue to harden. Install the control horns onto the flaps using four #2 x 3/8" [9.5 mm] self-tapping screws.

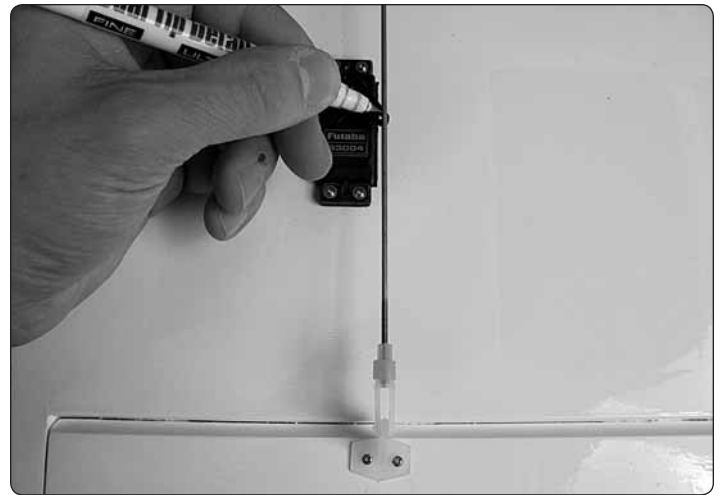

❑ 7. Use a felt-tip pen to mark the location where the pushrods cross the outer holes of the flap servo arms.

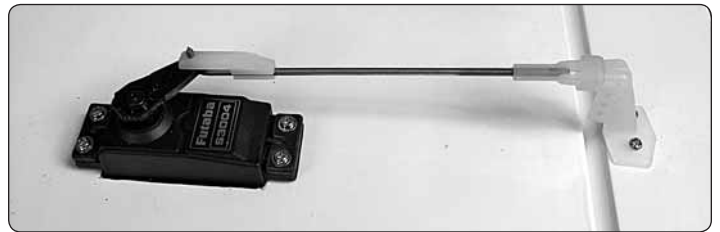

❑ 8. Just as you did with the aileron pushrods, bend each pushrod at a 90 degree angle at the marks you made. Cut off the excess pushrod 1/4" [6.4 mm] beyond the bends. Attach the pushrods to the servo arms using nylon FasLinks.

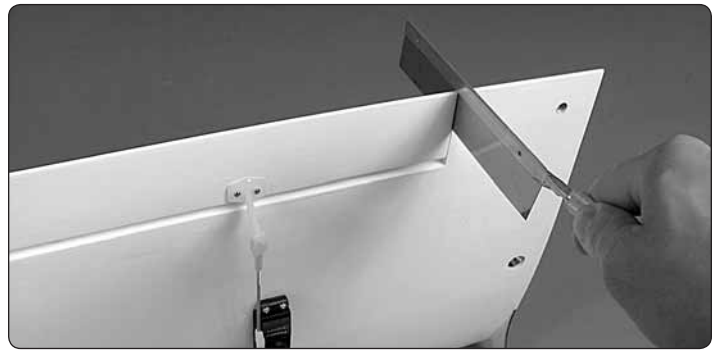

❑ 9. Wooden pins were installed at the factory that lock the flaps in place for those modelers who choose not to have operational flaps. Use a razor saw or similar tool to cut through the pins (the pins can be seen by looking at the inboard ends of the flaps). Take care not to cut into the flaps or wings.

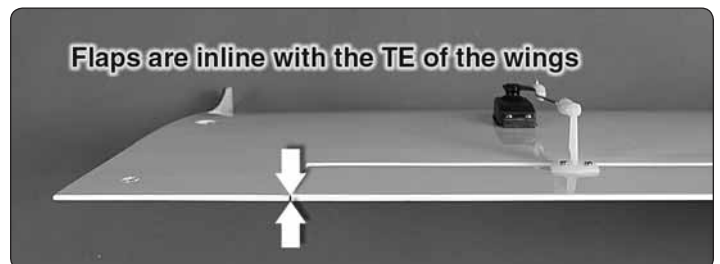

❑ 10. Test the operation of the flaps with your radio system. Unlike the ailerons, the flaps will only move in the down direction. If necessary, thread the clevises up or down on the

pushrods so that the flaps are inline with the trailing edge of the wings when the flap dial is rotated fully to its stop point. When satisfied, slide the silicone clevis retainers to the end of the clevises.

GET THE MODEL READY TO FLY

Check the Control Directions

❑ 1. Refer to the manual included with the radio for specific operating instructions. Turn on the transmitter and receiver and center the trims. If necessary, remove the servo arms from the servos and reposition them so they are centered. Reinstall the screws that hold on the servo arms.

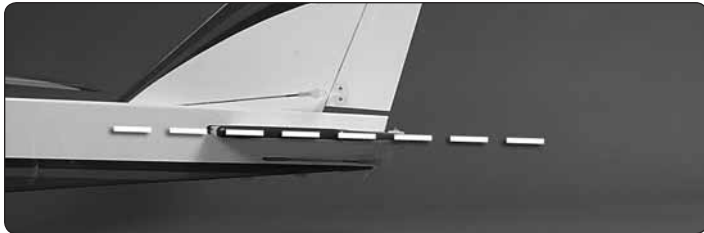

❑ 2. With the transmitter and receiver still on, view the elevator and stab from the end. The elevator should be centered as shown in the photo above. If the elevator is not centered with the stab, disconnect the clevis from the elevator control horn. Holding the end of the pushrod with pliers, screw or unscrew the clevis as necessary until the elevator is centered when reconnected to the pushrod.

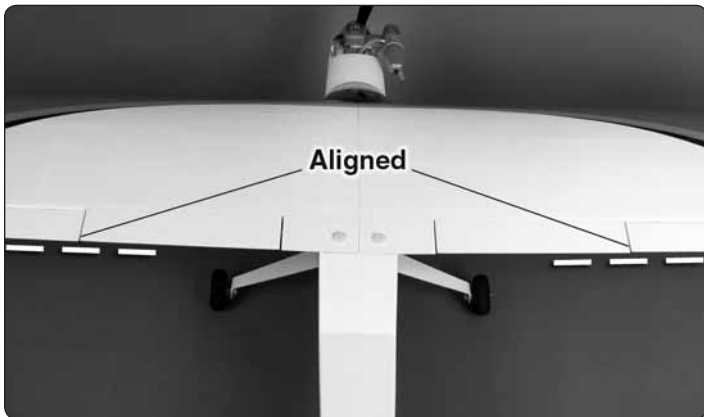

❑ 3. Center the rudder and ailerons by adjusting the clevises on the pushrods as necessary.

❑ 4. Once the rudder is centered, if necessary, center the nose wheel by loosening the screw in the screw-lock pushrod connector on the rudder servo arm. Move the pushrod forward or back to center the wheel. Securely tighten the screw and then push the airplane forward on a flat surface to verify that the airplane rolls straight.

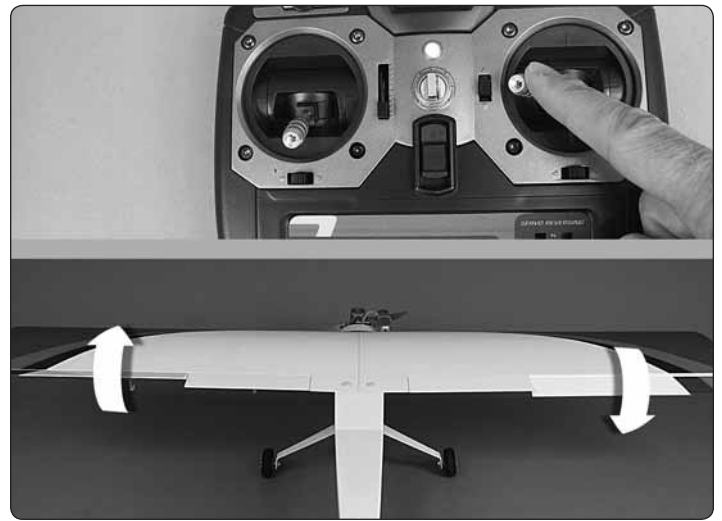

❑ 5. Make certain that the control surfaces and the throttle respond in the correct direction as shown in the diagram. If any

of the controls respond in the wrong direction, use the servo reversing in the transmitter to reverse the servos connected to those controls. Be certain the control surfaces have remained centered. Adjust if necessary.

Check the Throttle Operation

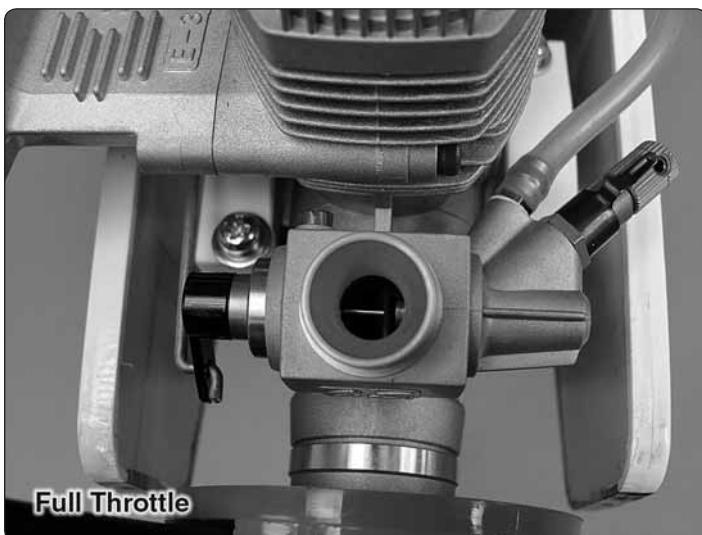
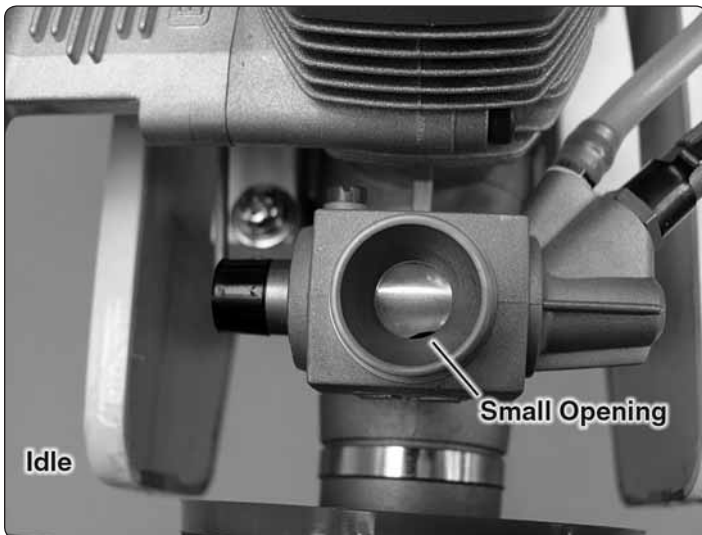
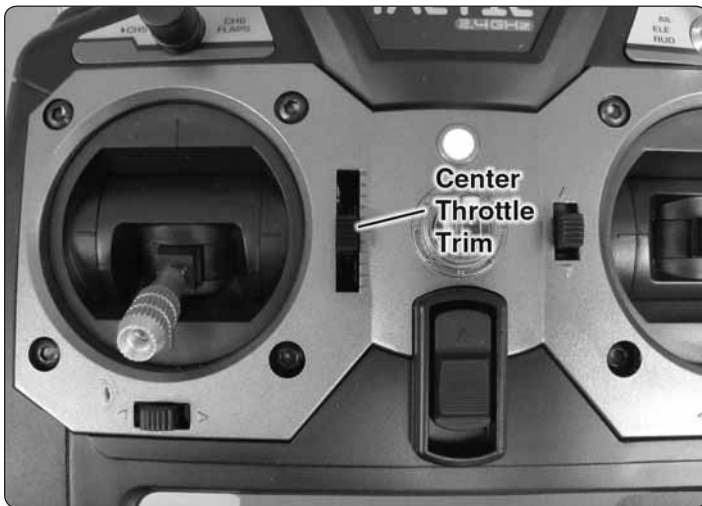

1. Turn on the transmitter and receiver and center the position of the throttle trim lever. Move the throttle stick to the

idle position (toward you) and look into the carburetor. The carburetor barrel should reveal only a small 3/64" [1.2mm] opening as shown that will keep the engine running at idle. Moving the throttle stick up to full throttle should open the carburetor completely.

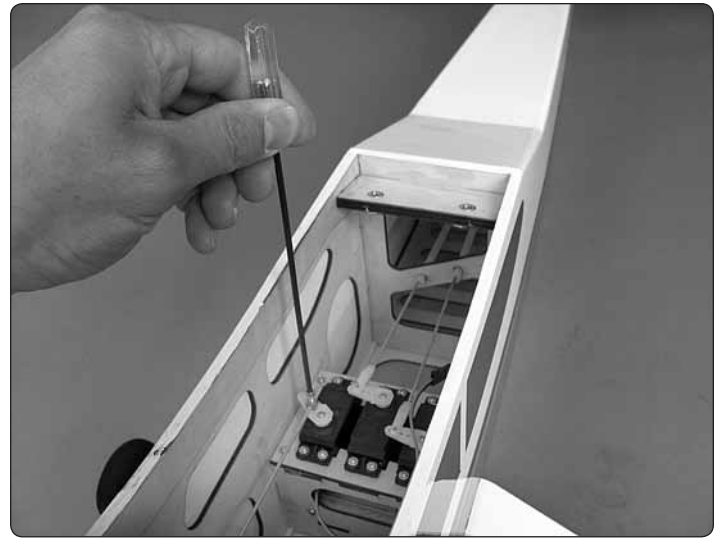

2. If the carburetor does not respond as shown in step 1, loosen the cap head screw that secures the throttle pushrod to the throttle servo and adjust the position of the pushrod in the screw lock pushrod connector so movement of the carb matches the photos.



3. In order to shut off the engine using the transmitter, slide the throttle trim lever all the way down. This should close the carburetor completely as shown. If closing the carburetor completely does not shut off the engine, pinch the fuel line that connects to the needle valve until the engine stops. Before running the engine again, determine why the engine would not stop running using the throttle trim lever. If you are sure that the carburetor closes completely, an air leak in the fuel line or around the carb body is probable.

Check the Control Throws

To ensure a successful first flight, check your Avistar Elite against the control throws specified in this manual. The throws have been determined through actual flight testing and accurate record-keeping, allowing the model to perform in the manner in which it was intended. If, after you have become accustomed to the way the Avistar Elite flies, you would like to change the throws to suit your taste, that is fine. However, too much control throw could make the model too responsive and difficult to control, so remember, "more is not always better."

Measure the **high rate** throws...

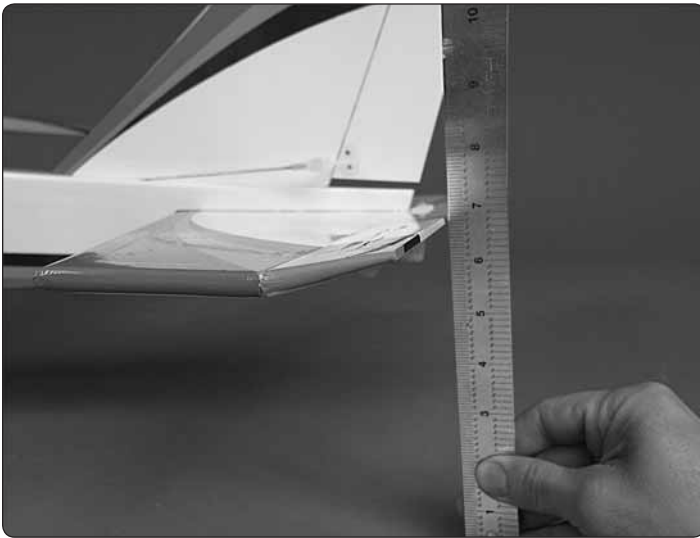

❑ 1. Place a ruler flat on your work surface against the elevator. Move the elevator up with your transmitter and move the ruler forward so it will remain contacting the trailing edge. The distance the elevator moves up from center is the "up" elevator throw. Measure the down elevator throw the same way.

❑ 2. Compare your measurements to the control throw table. The plane was set up from the factory so that the high rate throws should match or be very close to the measurements in the table. If the throws are significantly different (more than 1/8" [3mm]), we suggest altering the positions of the pushrods in the servo arms and control horns to mechanically change the control throw. If necessary, change the positions of the pushrods according to the sketches.

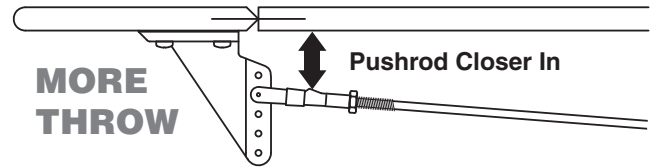
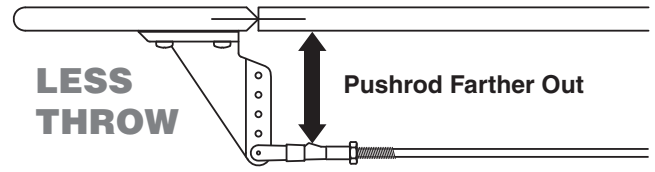

Pushrod Farther Out

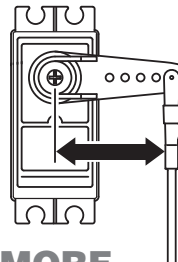

**MORE
THROW**

Pushrod Closer In

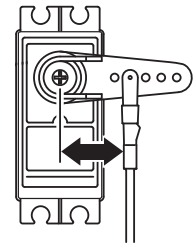

**LESS
THROW**

❑ 3. The dual rate switch will reduce the amount of control throw to the low rate values when the high rates match those provided in the table.

NOTE: The throws are measured at the **widest part** of the elevator, rudder and ailerons.

These are the recommended control surface throws:		
	LOW RATE	HIGH RATE
ELEVATOR	Up & Down 5/16" [8 mm] 11°	Up & Down 7/16" [11 mm] 16°
RUDDER	Right & Left 1/2" [13 mm] 13°	Right & Left 7/8" [22 mm] 22°
AILERONS	Up & Down 3/8" [10 mm] 11°	Up & Down 9/16" [14 mm] 17°

Balance the Model (C.G.)

More than any other factor, the C.G. (center of gravity/balance point) can have the greatest effect on how a model flies and could determine whether or not your first flight will be successful. If you value your model and wish to enjoy it for many flights, **DO NOT OVERLOOK THIS IMPORTANT PROCEDURE.** A model that is not properly balanced may be unstable and possibly unflyable.

At this stage the model should be in ready-to-fly condition with **all** of the components in place including the complete radio system, engine, muffler, propeller, and spinner. The fuel tank should be empty.

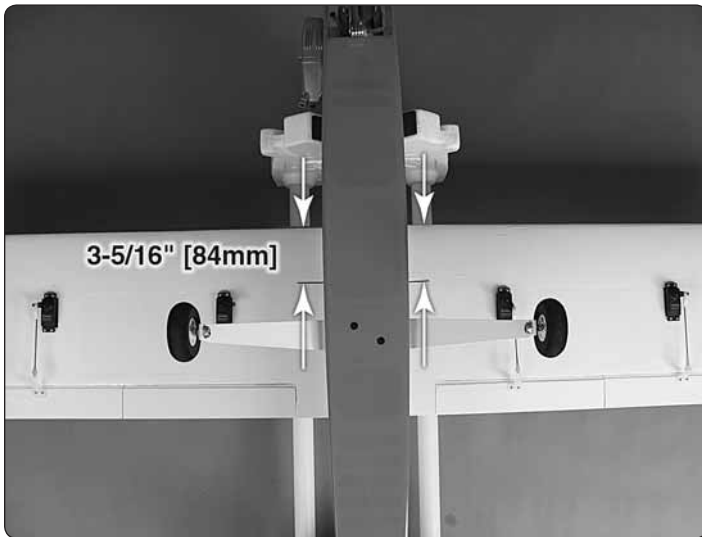

❑ 1. If using a Great Planes C.G. Machine, set the rulers to 3-5/16" [84mm]. If not using a C.G. Machine, use a fine-point felt tip pen to mark lines on the underside of the wing on both sides of the fuselage 3-5/16" [84mm] back from the leading edge. Apply narrow (1/16" [2mm]) strips of tape over the lines so you will be able to feel them when lifting the model with your fingers.

This is where your model should balance for the first flights. Later, you may experiment by shifting the C.G. 3/8" [9.5mm] forward or 3/8" [9.5mm] back to change the flying characteristics. Moving the C.G. forward will improve the smoothness and stability, but the model will then be less aerobatic (which may be fine for less-experienced pilots). Moving the C.G. aft makes the model more maneuverable and aerobatic for experienced pilots. In any case, **start at the recommended balance point** and do not at any time balance the model outside the specified range.



❑ 2. With the wing attached to the fuselage, all parts of the model installed (ready to fly) and an empty fuel tank, place the model on a Great Planes CG Machine, or lift it at the balance point you marked.

❑ 3. If the tail drops, the model is "tail heavy." If the nose drops, the model is "nose heavy." The receiver battery could be moved forward or aft inside the fuselage to shift the balance point of the model toward the recommended balancing point. If the receiver battery cannot be moved, or if additional weight is still required, nose weight may be easily added by using "spinner weight" (GPMQ4645 for the 1 oz. [28g] weight, or GPMQ4646 for the 2 oz. [57g] weight). If spinner weight is not practical or is not enough, or if tail weight is required, use Great Planes "stick-on" lead (GPMQ4485). To find out how much weight is required, place incrementally increasing amounts of weight on the top of the fuselage over the location where it would be mounted inside until the model balances. A good place to add stick-on nose weight is to the firewall. Once you have determined the amount of weight required, it can be permanently attached. If required, tail weight may be added by cutting open the bottom of the fuse and gluing it permanently inside.

Note: If mounting weight where it may be exposed to fuel or exhaust, do not rely upon the adhesive on the back to permanently hold it in place. Over time, fuel and exhaust residue may soften the adhesive and cause the weight to fall off. Instead, permanently attach the weight with glue or screws.

❑ 4. **IMPORTANT:** If you found it necessary to add any weight, recheck the C.G. after the weight has been installed.

Balance the Model Laterally

- ❑ 1. With the wing level, have an assistant help you lift the model by the engine propeller shaft and the bottom of the fuse under the TE of the fin. Do this several times.
- ❑ 2. If one wing always drops when you lift the model, it means that side is heavy. Balance the airplane by adding weight to the other wing tip. **An airplane that has been laterally balanced will track better in loops and other maneuvers.**

PREFLIGHT

Identify Your Model

No matter if you fly at an AMA sanctioned R/C club site or if you fly somewhere on your own, you should always have your name, address, telephone number and AMA number on or inside your model. It is **required** at all AMA R/C club flying sites and AMA sanctioned flying events. Fill out the identification tag on page 16 and place it on or inside your model.

Balance Propellers

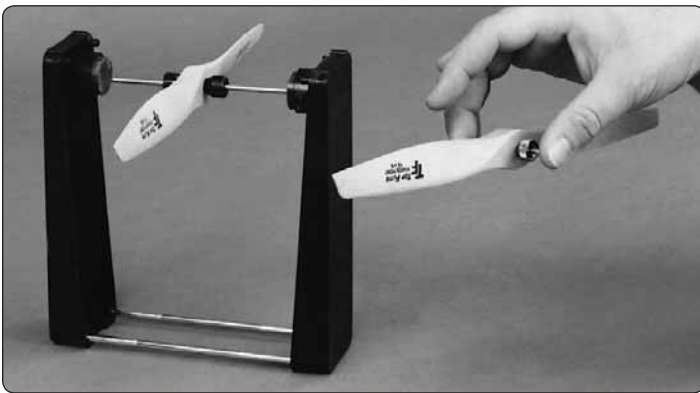

Carefully balance your propeller and spare propellers before you fly. An unbalanced prop can be the single most significant cause of vibration that can damage your model. Not only will engine mounting screws and bolts loosen, possibly with disastrous effect, but vibration may also damage your radio receiver and battery. Vibration can also cause your fuel to foam, which will, in turn, cause your engine to run hot or quit.

We use a Top Flite Precision Magnetic Prop Balancer (TOPQ5700) in the workshop and keep a Great Planes Fingertip Prop Balancer (GPMQ5000) in our flight box.

Ground Check

Follow the engine manufacturer's instructions to break-in a new engine. After break-in, confirm that the engine idles reliably, transitions smoothly and rapidly to full power and maintains full power—indefinitely. After you run the engine on the model, inspect the model closely to make sure all screws remained tight, the hinges are secure, the prop is secure and all pushrods and connectors are secure.

Range Check

Ground check the operational range of your radio before the first flight of the day. Refer to your radio manual for the range checking procedure of your radio system. During the check, have an assistant stand by your model and, while you work the controls, tell you what the control surfaces are doing. Repeat this test **with the engine running** at various speeds with an assistant holding the model, using hand signals to show you what is happening. If the control surfaces do not respond correctly, **do not fly!** Find and correct the problem first. Look for loose servo connections or broken wires, corroded wires on old servo connectors, poor solder joints in your battery pack or a defective cell.

ENGINE SAFETY PRECAUTIONS

Failure to follow these safety precautions may result in severe injury to yourself and others.

- Keep all engine fuel in a safe place, away from high heat, sparks or flames, as fuel is very flammable. Do not smoke near the engine or fuel; and remember that engine exhaust gives off a great deal of deadly carbon monoxide. Therefore **do not run the engine in a closed room or garage.**
- Get help from an experienced pilot when learning to operate engines.
- Use safety glasses when starting or running your engine.
- Do not run the engine in an area of loose gravel or sand; the propeller may throw such material in your face or eyes.
- Keep your face and body as well as all spectators away from the plane of rotation of the propeller as you start and run the engine.
- Keep these items away from the prop: loose clothing, shirt sleeves, ties, scarfs, long hair or loose objects such as pencils or screwdrivers that may fall out of shirt or jacket pockets into the prop.
- Use a "chicken stick" or electric starter to start the engine. Do not use your fingers to flip the propeller. Make certain the glow plug clip or connector is secure so that it will not pop off or otherwise get into the running propeller.
- Make all engine adjustments from behind the rotating propeller.
- The engine will get hot! Do not touch it during or right after operation. Make sure fuel lines are in good condition so fuel will not leak onto a hot engine, causing a fire.
- To stop a glow engine, use your radio system to completely shut the carburetor barrel or if that method fails to work, cut off the fuel supply by closing off the fuel line. Do not use hands, fingers or any other body part to try to stop the engine. Do not throw anything into the propeller of a running engine.

AMA SAFETY CODE EXCERPTS

Read and abide by the following excerpts from the Academy of Model Aeronautics Safety Code. For the complete Safety Code refer to *Model Aviation* magazine, the AMA web site or the Code that came with your AMA license.

General

1) I will not fly my model aircraft in sanctioned events, air shows, or model flying demonstrations until it has been proven to be airworthy by having been previously, successfully flight tested.

2) I will not fly my model aircraft higher than approximately 400 feet within 3 miles of an airport without notifying the airport operator. I will give right-of-way and avoid flying in the proximity of full-scale aircraft. Where necessary, an observer shall be utilized to supervise flying to avoid having models fly in the proximity of full-scale aircraft.

3) Where established, I will abide by the safety rules for the flying site I use, and I will not willfully and deliberately fly my models in a careless, reckless and/or dangerous manner.

5) I will not fly my model unless it is identified with my name and address or AMA number, on or in the model. Note: This does not apply to models while being flown indoors.

7) I will not operate models with pyrotechnics (any device that explodes, burns, or propels a projectile of any kind).

Radio Control

1) I will have completed a successful radio equipment ground check before the first flight of a new or repaired model.

2) I will not fly my model aircraft in the presence of spectators until I become a qualified flier, unless assisted by an experienced helper.

3) At all flying sites a straight or curved line(s) must be established in front of which all flying takes place with the other side for spectators. Only personnel involved with flying the aircraft are allowed at or in the front of the flight line. Intentional flying behind the flight line is prohibited.

4) I will operate my model using only radio control frequencies currently allowed by the Federal Communications Commission.

5) **I will not knowingly operate my model within three miles of any pre-existing flying site except in accordance with the frequency sharing agreement listed** [in the complete AMA Safety Code].

9) Under no circumstances may a pilot or other person touch a powered model in flight; **nor should any part of the model other than the landing gear, intentionally touch the ground, except while landing.**

CHECK LIST

During the last few moments of preparation your mind may be elsewhere anticipating the excitement of the first flight. Because of this, you may be more likely to overlook certain checks and procedures that should be performed before the model is flown. To help avoid this, a check list is provided to make sure these important areas are not overlooked. Many are covered in the instruction manual, so where appropriate, refer to the manual for complete instructions. Be sure to check the items off as they are completed (that's why it's called a *check list!*).

- 1. Check the C.G. according to the measurements provided in the manual.
- 2. Be certain the battery and receiver are securely mounted in the fuse. Simply stuffing them into place with foam rubber is not sufficient.
- 3. Balance your model *laterally* as explained in the instructions.
- 4. Confirm that all hinges are **securely** glued in place.
- 5. Confirm that all controls operate in the correct direction and the throws are set up according to the manual.
- 6. Make sure there are silicone retainers on all the clevises and that all servo arms are secured to the servos with the screws included with your radio.
- 7. Make sure any servo extension cords you may have used do not interfere with other systems (servo arms, pushrods, etc.).
- 8. Secure the pressure tap (if used) to the muffler with high temp RTV silicone, thread locking compound or J.B. Weld.
- 9. Make sure the fuel lines are connected and are not kinked.
- 10. Balance your propeller (and spare propellers).
- 11. Tighten the propeller nut and spinner.
- 12. Place your name, address, AMA number and telephone number on or inside your model.
- 13. If you wish to photograph your model, do so before your first flight.
- 14. Range check your radio when you get to the flying field.

GATHER YOUR TOOLS

In addition the equipment required to fuel and start the engine mentioned near the beginning of the manual, you should start a collection of tools that may be required for adjustments and maintenance at the flying field. Following is a list of the most important items.

- Medium (#1) Phillips Screwdriver
- Medium (#1) Flat Screwdriver
- 5/16" (or 8mm) Socket Wrench (for glow plug)
- 10mm Wrench or Crescent Wrench (for the propeller)

SPARE PARTS

- Glow plug (OS #8 recommended - OSMG2691)
- Propeller (GPMA4287)



Selecting the correct propeller for an airplane is very important. Your Avistar Elite RTF Select comes equipped with a specially designed nylon 12x5 propeller. These are the features explained:

The propeller is made out of flexible nylon so that it won't break on light contact with the runway or weeds. If the propeller ever gets in contact with anything while the engine is running, inspect it before running it again. Check for cracks, scuffed tips or unbalanced blades. If necessary, replace the propeller.

The Avistar Elite RTF was designed around an 12x5 propeller for best performance. The 12x5 propeller helps keep the airplane speed down at full throttle; it increases take off performance on any surface, including tall grass; and it acts as a brake when the nose is pointed down. Should you ever need to replace the propeller, replace it with the same or similar 12x5 propeller. There is no benefit to using a larger propeller or one with more pitch.

FUELING THE AVISTAR ELITE

The Avistar Elite comes with a three-line fuel line system. To fuel the airplane, remove the fuel line plug from the filling line (green) and connect the fuel pump to it. Disconnect the clear line from the exhaust. Fill the tank until fuel comes out the clear line. Re-connect the clear line to the exhaust nipple. Replace the plug to the fill line. The airplane is now fueled.

To remove fuel from the fuel tank, remove the fuel line plug from the filling line (green) and connect the pump to it. Pump out any fuel that may be in the fuel tank. Replace the fuel line plug to the green line. **NOTE:** You may have to lower the nose of the airplane to completely de-fuel the tank.

STARTING YOUR O.S. .46 AX II

Your OS .46 AX II has been optimized to be easy to handle and start. The following comments are not intended to replace the manufacturer's instructions but to complement them. After many hours of testing, this is the best starting procedure we have developed for this engine.

- Make sure your fuel tank is filled with fuel. Any quality model airplane fuel with 0% to 15% nitromethane content will work well.
- Make sure none of the fuel lines are kinked or pinched and that fuel is free to flow into the carburetor.
- The high-speed needle should be opened 2 turns out from the closed position.
- Set your throttle to wide open.

- Cover the carburetor opening with your finger, grab the propeller and turn it counterclockwise several times until you can see fuel flowing into the carburetor through the carburetor line.
- Install the glow starter to the glow plug (make sure it is fully charged).
- Set your throttle to idle (carburetor is about 3/64" [1.2mm] open).
- To hand start the engine, use a chicken stick or thick gloves to push the propeller blade rapidly through compression in a counter-clockwise direction. Move your hands away from the propeller immediately! It may take several tries to start the engine, especially during the first several runs while the engine is breaking in.
- After the engine has started, carefully remove the glow driver from the glow plug.
- Adjust the high-speed needle.

ADJUSTING THE NEEDLE VALVE AND BREAK IN THE ENGINE



If you are starting your O.S. engine for the first time, run the engine for one minute with the throttle fully open and the high-speed needle valve adjusted for rich, slow, "four-cycle" operation. This fuel-rich setting provides an adequate amount of lubrication to the engine during break-in. Four-cycle operation has an erratic combustion sound accompanied by rich smoke from the muffler. Take care to make all needle valve adjustments from behind the engine and keep your fingers clear of the spinning propeller.

Now close the high-speed needle valve until the engine speeds up to "two-cycle" operation. Engine pitch will increase and become a clear, continuous combustion noise. Allow it to run for about 10 seconds. Then, re-open the needle valve to bring the engine back to "four-cycle" operation and run it for another 10 seconds. Repeat this procedure until the fuel tank is empty.

Re-start and adjust the needle valve until the engine just breaks into "two-cycle" from "four-cycle" operation. The first three or four flights should be made with this needle setting. During subsequent flights, the needle valve can be closed gradually to give more power. To prevent "too lean" operation, do not run the engine continuously at the highest rpm allowed by the high-speed needle valve setting. The needle valve should be richened from the highest rpm setting allowed by the high-

speed needle valve at full throttle until an audible drop in RPM is heard. If checking with a tachometer, the engine should be run at approximately 200 rpm below the maximum rpm.

ADJUSTING THE MIXTURE CONTROL VALVE

The mixture control valve is the small slotted screw located at the end of the carburetor opposite the throttle arm. With the engine running, close the throttle and allow it to idle for about five seconds, and then open the throttle fully. If the engine is slow to pick up and produces an excess of exhaust smoke, the mixture is too rich. Correct this condition by turning the mixture control valve clockwise 15-30°. If the mixture is excessively rich, engine rpm will become unstable. Opening the throttle will produce a great deal of smoke and rpm may drop suddenly or the engine may stop. If the mixture is too lean, you will notice a lack of exhaust smoke and a tendency for the engine to cut out when the throttle is opened. In this case, turn the mixture control valve counter-clockwise 90° to richen the idle mixture, and then turn the valve clockwise gradually until the engine regains full power cleanly when the throttle is reopened.

FLYING

Do not attempt to fly by yourself if you are a beginning pilot. The Avistar's docile flying characteristics makes learning to fly R/C an easier experience, but the help from an instructor is invaluable. An instructor is going to be able to inspect your airplane to make sure everything is working correctly and he will also be able to give you a few tips and comments on how to improve your flying. Also, make sure you fly at an AMA sanctioned flying field.

CAUTION (THIS APPLIES TO ALL R/C AIRPLANES): If, while flying, you notice an alarming or unusual sound such as a low-pitched "buzz," this may indicate control surface *flutter*. Flutter occurs when a control surface (such as an aileron or elevator) or a flying surface (such as a wing or stab) rapidly vibrates up and down (thus causing the noise). In extreme cases, if not detected immediately, flutter can actually cause the control surface to detach or the flying surface to fail, thus causing loss of control followed by an impending crash. The best thing to do when flutter is detected is to slow the model **immediately** by reducing power, then land as soon as safely possible. Identify which surface fluttered (so the problem may be resolved) by checking all the servo grommets for deterioration or signs of vibration. Make certain all pushrod linkages are secure and free of play. If it fluttered once, under similar circumstances it will probably flutter again unless the problem is fixed. Some things which can cause flutter are; Excessive hinge gap; Not mounting control horns solidly; Poor fit of clevis pin in horn; Side-play of wire pushrods caused by large bends; Excessive free play in servo gears; Insecure servo mounting; and one of the most prevalent causes of flutter; Flying an over-powered model at excessive speeds.

Taxiing

Before the model is ready for takeoff, it must first be set up to roll straight down the runway. With the engine running at a low idle, place the plane on the runway and, if your flying field permits, stand behind the model. Advance the throttle just enough to allow the model to roll. If the model does not roll straight down the runway, shut the engine off and adjust the nose gear pushrod as necessary. Do not use the rudder trim to correct the nose wheel because this will also affect the rudder. **Note:** Crosswinds may affect the direction the model rolls, so this test should be done in calm conditions, or with the model facing directly into the wind.

Takeoff

It is typical when flying with an instructor to allow him or her to have control during take off and landing for at least your first couple of flights. Allow yourself time to become comfortable with the sticks in the air before attempting a complete flight on your own if you are a beginning pilot.

If possible, take off directly into the wind. If you are experienced, taking off in a crosswind is permissible (and sometimes necessary—depending upon the prevailing wind conditions and runway heading). Taking off into the wind will help the model roll straight and also reduces ground speed for takeoff. Taxi the model onto the runway or have an assistant carry it out and set it down, pointing down the runway into the wind. When ready, lower the flaps (if equipped) and gradually advance the throttle while simultaneously using the left stick (rudder/nose wheel) to steer the model. Gain as much speed as the runway and flying site will practically allow before gently applying up elevator lifting the model into the air. Be ready to make immediate corrections with the ailerons to keep the wings level, and be smooth on the elevator stick, allowing the model to establish a gentle climb to a safe altitude before making the first turn (away from yourself). Do not "yank" back the elevator stick forcing the plane into too steep of a climb which could cause the model to quit flying and stall.

Flight

Once airborne, maintain a steady climb and make the initial turn away from the runway. When at a comfortable, safe altitude, throttle back to slow the model and raise the flaps (if equipped), thus giving you time to think and react. The Avistar Elite should fly well at half or slightly less than half throttle. Adjust the trims so the plane flies straight and level. After flying around for a while, and while still at a safe altitude with plenty of fuel (or battery charge), practice slow flight and execute practice landing approaches by reducing the throttle further to see how the model handles when coming in to land. Add power to see how the model climbs as well. Continue to fly around while learning how the model responds. Mind your fuel level, but use this first flight to become familiar with the model before landing.

Landing

When ready to land, gently lower the flaps (if equipped) and pull the throttle stick fully back while flying downwind just before making the 180-degree turn toward the runway. Allow the nose of the model to pitch downward to gradually bleed off altitude. Continue to lose altitude, but maintain airspeed by keeping the nose down while turning. Apply up elevator to level the plane when it reaches the end of the runway and is about five to ten feet off the ground. If the model is too far away, carefully add a small amount of power to fly the model closer. If going too fast, smoothly advance the throttle and allow the model to gain airspeed, then apply elevator to climb out and go around to make another attempt. When finally ready to touch down, continue to apply up elevator, but not so much that the airplane will climb. Continue to apply up elevator while the plane descends until it gently touches down.

After you have landed and shut the engine off, adjust the pushrods on the ailerons, elevator and rudder as necessary so the trim levers on the transmitter may be returned to center. This will not be required on any of the controls that did not need trim adjustments.

MAINTENANCE TIPS

Clean Up

- After flying for the day, use your fuel pump to drain excess fuel from the tank.

This model belongs to:					
Name					
Address					
City, State, Zip					
Phone Number					
AMA Number					

- After each day's flying, use spray cleaner and paper towels to thoroughly clean the model.
- The Avistar Elite is factory-covered with iron-on model covering film. Should repairs ever be required, the covering can be patched with new pieces of iron-on covering. Among several types of covering that will work, Top Flite MonoKote film may be used to make repair patches to this model. MonoKote is packaged in six-foot rolls, but some hobby shops also sell it by the foot. If only a small piece of covering is needed for a minor patch, perhaps a fellow modeler would give you some. The covering is applied with a model airplane covering iron, but in an emergency a regular iron set to a lower temperature could be used.
- Check all screws that hold the wings together, tail bolts, engine bolts, wheel collars, etc.
- Check all the high-stress areas for cracks or fatigue such as the landing gear area, the wing mounting area, stab and fin mounting area.

FINAL NOTE

One final note about flying your model. Have a goal or flight plan in mind for **every** flight. For beginners, your first few flights should be you becoming familiar with the basic controls of R/C. When the plane is flying toward you it is common for beginner pilots to hesitate or turn the plane in the wrong direction because the aileron and rudder control will act in reverse from the pilot's perspective as it was when flying away from them. Focus on flying the model as if you were sitting in the cockpit. With practice you will learn to do this without having to think about it.

As you progress, your flight plans should include smooth takeoffs and landings. Practice executing smooth landings such that the Avistar approaches the runway in a smooth and descending path with the correct airspeed and touches down without bouncing. If possible at your airfield, perform several "touch and go" landings until you are comfortable with the plane's landing characteristics.

Regardless of your objective for each flight, do not surprise yourself by impulsively attempting a maneuver and suddenly finding that you've run out of time, altitude or airspeed. Every maneuver should be deliberate, not impulsive. For example, if you're going to do a loop, check your altitude, mind the wind direction (anticipating rudder corrections that will be required to maintain heading), remember to throttle back at the top, and make certain you are on the desired rates (high/low rates). A flight plan greatly reduces the chances of crashing your model just because of poor planning and impulsive moves. **Remember to think.**

Have a ball! But always stay in control and fly in a safe manner.

GOOD LUCK AND GREAT FLYING!