

PBY CATALINA

INSTRUCTION MANUAL



Wingspan: 53.5 in [1360mm]
Wing Area: 395 sq in [25.5dm²]
Weight: 3-3.25 lb [1360-1470g]
Wing Loading: 18-19 oz/sq ft [55-58 g/dm²]
Length: 34.25 in [870mm]
Radio: 4-Channel with Two Micro-Mini and Two Micro Servos
Motor: Two 28-30-950 RimFire™ Brushless Motors and
Two ElectrIFly SS-25 Speed Controls

ElectrIFly™

WARRANTY

Great Planes® Model Manufacturing Co. guarantees this kit to be free from defects in both material and workmanship at the date of purchase. This warranty does not cover any component parts damaged by use or modification. **In no case shall Great Planes' liability exceed the original cost of the purchased kit.** Further, Great Planes reserves the right to change or modify this warranty without notice.

In that Great Planes has no control over the final assembly or material used for final assembly, no liability shall be assumed nor accepted for any damage resulting from the use by the user of the final user-assembled product. By the act of using the user-assembled product, the user accepts all resulting liability.

If the buyer is not prepared to accept the liability associated with the use of this product, the buyer is advised to return

this kit immediately in new and unused condition to the place of purchase.

To make a warranty claim send the defective part or item to Hobby Services at the address below:

Hobby Services
3002 N. Apollo Dr., Suite 1
Champaign, IL 61822 USA

Include a letter stating your name, return shipping address, as much contact information as possible (daytime telephone number, fax number, e-mail address), a detailed description of the problem and a photocopy of the purchase receipt. Upon receipt of the package, the problem will be evaluated as quickly as possible.

READ THROUGH THIS MANUAL BEFORE STARTING CONSTRUCTION. IT CONTAINS IMPORTANT INSTRUCTIONS AND WARNINGS CONCERNING THE ASSEMBLY AND USE OF THIS MODEL.



Champaign, Illinois
(217) 398-8970, Ext 5
airsupport@greatplanes.com

TABLE OF CONTENTS

INTRODUCTION	2
AMA	2
SAFETY PRECAUTIONS	3
LITHIUM BATTERY HANDLING AND USAGE	3
DECISIONS YOU MUST MAKE	3
Radio Equipment	3
Motor Recommendations	3
ADDITIONAL ITEMS REQUIRED	4
Adhesives and Building Supplies	4
Optional Supplies and Tools	4
IMPORTANT BUILDING NOTES	4
ORDERING REPLACEMENT PARTS	4
KIT CONTENTS	5
PREPARATIONS	6
ASSEMBLE THE WING	6
ASSEMBLE THE FUSELAGE	9
Install the Stab, Elevators and Rudder	9
Install the Elevator & Rudder Servos & Pushrods	11
Install the Speed Control, Receiver & Batteries	12
FINAL ASSEMBLY	14
Complete the Radio Installation	14
Finishing Touches	14
GET THE MODEL READY TO FLY	15
Install & Connect the Motor Battery	15
Set the Control Throws	16
Balance the Model (C.G.)	16
Balance the Model Laterally	17
PREFLIGHT	17
Identify Your Model	17
Charge the Batteries	17
Balance Propellers	17
Range Check	17
MOTOR SAFETY PRECAUTIONS	17
AMA SAFETY CODE	18
CHECK LIST	18
FLYING	19
Takeoff	19
Flight	19
Landing	19

INTRODUCTION

The PBY Catalina has had a long and glorious service through the history of aviation, handling everything from search and rescue to monitoring our coast line during times of war. With the reliability and power of today's most advanced brushless motors and batteries, the ElectriFly PBY Catalina is a reliable and agile flying model of this famous twin engine airplane.

For the latest technical updates or manual corrections to the ElectriFly PBY Catalina visit the Great Planes web site at www.greatplanes.com. Open the "Airplanes" link, then select the PBY Catalina ARF. If there is new technical information or changes to this model, a "tech notice" box will appear in the upper left corner of the page.

AMA

We urge you to join the AMA (Academy of Model Aeronautics) and a local R/C club. The AMA is the governing body of model aviation and membership is required to fly at AMA clubs. Though joining the AMA provides many benefits, one of the primary reasons to join is liability protection. Coverage is not limited to flying at contests or on the club field. It even applies to flying at public demonstrations and air shows. Failure to comply with the Safety Code (excerpts printed in the back of the manual) may endanger insurance coverage. Additionally, training programs and instructors are available at AMA club sites to help you get started the right way. There are over 2,500 AMA chartered clubs across the country. Contact the AMA at the address or toll-free phone number below.



Academy of Model Aeronautics

5151 East Memorial Drive

Muncie, IN 47302

Tele: (800) 435-9262

Fax (765) 741-0057

Or via the Internet at:

<http://www.modelaircraft.org>

IMPORTANT!!! Two of the most important things you can do to preserve the radio controlled aircraft hobby are to avoid flying near full-scale aircraft and avoid flying near or over groups of people.

PROTECT YOUR MODEL, YOURSELF & OTHERS...FOLLOW THESE IMPORTANT SAFETY PRECAUTIONS

1. Your PBY Catalina should not be considered a toy, but rather a sophisticated, working model that functions very much like a full-size airplane. Because of its performance capabilities, the PBY Catalina, if not assembled and operated correctly, could possibly cause injury to yourself or spectators and damage to property.

2. You must assemble the model **according to the instructions**. Do not alter or modify the model, as doing so may result in an unsafe or unflyable model. In a few cases the instructions may differ slightly from the photos. In those instances the written instructions should be considered as correct.

3. You must take time to build **straight, true and strong**.

4. You must use an R/C radio system that is in first-class condition, and a correctly sized motor and components throughout the building process.

5. You must correctly install all R/C and other components so that the model operates correctly on the ground and in the air.

6. You must check the operation of the model before **every** flight to insure that all equipment is operating and that the model has remained structurally sound. Be sure to check clevises or other connectors often and replace them if they show any signs of wear or fatigue.

7. If you are not an experienced pilot or have not flown this type of model before, we recommend that you get the assistance of an experienced pilot in your R/C club for your first flights. If you're not a member of a club, your local hobby shop has information about clubs in your area whose membership includes experienced pilots.

We, as the kit manufacturer, provide you with a top quality, thoroughly tested kit and instructions, but ultimately the quality and flyability of your finished model depends on how you build it; therefore, we cannot in any way guarantee the performance of your completed model, and no representations are expressed or implied as to the performance or safety of your completed model.

Remember: Take your time and follow the instructions to end up with a well-built model that is straight and true.

LITHIUM BATTERY HANDLING & USAGE

WARNING!! Read the entire instruction sheet included with the battery. Failure to follow all instructions could cause permanent damage to the battery and its surroundings, and cause bodily harm!

- ONLY use a LiPo approved charger. NEVER use a NiCd/ NiMH peak charger!
- NEVER charge in excess of 4.20V per cell.
- ONLY charge through the "charge" lead. NEVER charge through the "discharge" lead.
- NEVER charge at currents greater than 1C.
- ALWAYS set charger's output volts to match battery volts.
- ALWAYS charge in a fireproof location.
- NEVER trickle charge.
- NEVER allow battery temperature to exceed 150° F (65° C).
- NEVER disassemble or modify pack wiring in any way or puncture cells.
- NEVER discharge below 2.5V per cell.
- NEVER place on combustible materials or leave unattended during charge or discharge.
- ALWAYS KEEP OUT OF REACH OF CHILDREN.

DECISIONS YOU MUST MAKE

This is a partial list of items required to finish the PBY Catalina that may require planning or decision making before starting to build. Order numbers are provided in parentheses.

Radio Equipment

- 4-Channel Radio (such as the Futaba® 4EXA)
- Micro Receiver (If you choose to, a standard size receiver will fit in the radio compartment)
- Two S3103 Micro-Mini Servos (FUTM0037) for the ailerons (or an equivalent servo with 17 oz-in of torque and servo case dimensions of 0.9" x 0.4" x 0.8" [22 x 11 x 20mm])
- Two S3110 Micro Servos (FUTM0046) for the elevator and rudder (or an equivalent servo with 22 oz-in of torque and servo case dimensions of 0.9" x 0.4" x 0.8" [22 x 11 x 20mm])
- Two 6" [150mm] Servo Extensions (HCAM2701 for Futaba)
- Two Servo Y-Harnesses (HCAM2751 for Futaba)

Motor, Speed Control and Battery Recommendation

- Two RimFire Brushless 28-30-950 Motors (GPMG4560)
- Two ElectriFly SS-25 Speed Controls (GPMM1820)
- One Deans U Parallel ESC adapter (GPMM3141)
- ElectriFly Power Series Lithium Polymer Battery. 2100mAh 11.1 Volt (GPMP0617), 3200mAh 11.1 Volt (GPMP0623) or equivalent
- ElectriFly PolyCharge™ 4 Battery Charger (GPMM3015)

ADDITIONAL ITEMS REQUIRED

Adhesives and Building Supplies

This is the list of Adhesives and Building Supplies that are required to finish the PBY Catalina.

- 1/2 oz. [15g] Thin Pro™ CA (GPMR6001)
- 1/2 oz. [15g] Medium Pro CA+ (GPMR6007)
- Pro 6-Minute Epoxy (GPMR6045)
- Drill Bits: 1/16" [1.6mm] and a #57
- #1 Hobby Knife (HCAR0105)
- #11 Blades (5-pack, HCAR0211)
- R/C-56 Canopy Glue (JOZR5007)
- Denatured Alcohol (for epoxy clean up)
- Threadlocker thread locking cement (GPMR6060)

Optional Supplies and Tools

Here is a list of optional tools mentioned in the manual that will help you build the PBY Catalina.

- 21st Century® Sealing Iron (COVR2700)
- 21st Century Iron Cover (COVR2702)
- CA Applicator Tips (HCAR3780)
- CA Debonder (GPMR6039)
- Epoxy Brushes (6, GPMR8060)
- Mixing Sticks (50, GPMR8055)
- Mixing Cups (GPMR8056)

IMPORTANT BUILDING NOTES

- When you see the term **test fit** in the instructions, it means that you should first position the part on the assembly **without using any glue**, then slightly modify or *custom fit* the part as necessary for the best fit.
- Whenever the term **glue** is written you should rely upon your experience to decide what type of glue to use. When a specific type of adhesive works best for that step, the instructions will make a recommendation.
- Whenever just **epoxy** is specified you may use **either** 30-minute (or 45-minute) epoxy **or** 6-minute epoxy.
- **Photos** and **sketches** are placed **before** the step they refer to. Frequently you can study photos in following steps to get another view of the same parts.

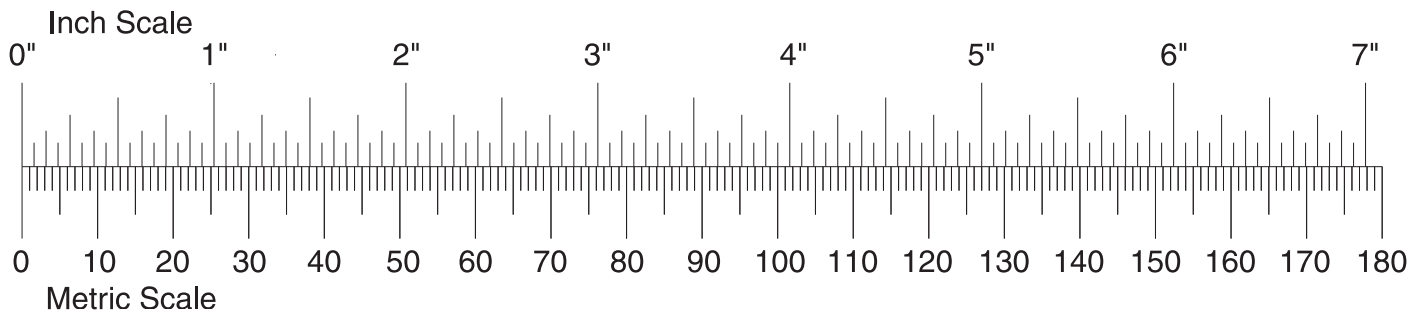

ORDERING REPLACEMENT PARTS

Replacement parts for the ElectriFly PBY Catalina ARF are available using the order numbers in the Replacement Parts List that follows. The fastest, most economical service can be provided by your hobby dealer or mail-order company.

To locate a hobby dealer, visit the Great Planes web site at www.greatplanes.com. Choose "Where to Buy" at the bottom of the menu on the left side of the page. Follow the instructions provided on the page to locate a U.S., Canadian or International dealer.

Parts may also be ordered directly from Hobby Services by calling (217) 398-0007, or via facsimile at (217) 398-7721, but full retail prices and shipping and handling charges will apply. Illinois and Nevada residents will also be charged sales tax. If ordering via fax, include a Visa® or MasterCard® number and expiration date for payment.

Mail parts orders and payments by personal check to:

Hobby Services
3002 N. Apollo Drive, Suite 1
Champaign, IL 61822

Be certain to specify the order number exactly as listed in the **Replacement Parts List**. Payment by credit card or personal check only; no C.O.D.

If additional assistance is required for any reason, contact Product Support by telephone at (217) 398-8970, or by e-mail at productsupport@greatplanes.com.

Replacement Parts List

Order Number	Description	How to Purchase
	Missing pieces	Contact Product Support
	Instruction manual.....	Contact Product Support
	Full-size plans	Not available
GPMA2188	Fuselage	Contact Hobby Supplier
GPMA2189	Wing Set	Contact Hobby Supplier
GPMA2190	Tail Surfaces.....	Contact Hobby Supplier
GPMA2191	Wing Strut Set.....	Contact Hobby Supplier
GPMA2192	Battery Hatch	Contact Hobby Supplier
GPMA2193	Prop Adapter/ Hub (1).....	Contact Hobby Supplier
GPMA2194	Canopies (2)	Contact Hobby Supplier
GPMA2195	Water Rudder.....	Contact Hobby Supplier
GPMA2196	Wing Tip Float Set.....	Contact Hobby Supplier
GPMA2197	Decal Set	Contact Hobby Supplier
GPMA2198	Cowls (2).....	Contact Hobby Supplier
GPMQ6610	8" x 6" Propeller.....	Contact Hobby Supplier

KIT INSPECTION

Before starting to build inspect the parts to make sure they are of acceptable quality. If any parts are missing or are not of acceptable quality, or if you need assistance with assembly, contact **Product Support**. When reporting defective or missing parts, use the part names exactly as they are written in the Kit Contents list.

Great Planes Product Support
3002 N. Apollo Drive, Suite 1
Champaign, IL 61822
Telephone: (217) 398-8970, ext. 5
Fax: (217) 398-7721
E-mail: airsupport@greatplanes.com

KIT CONTENTS

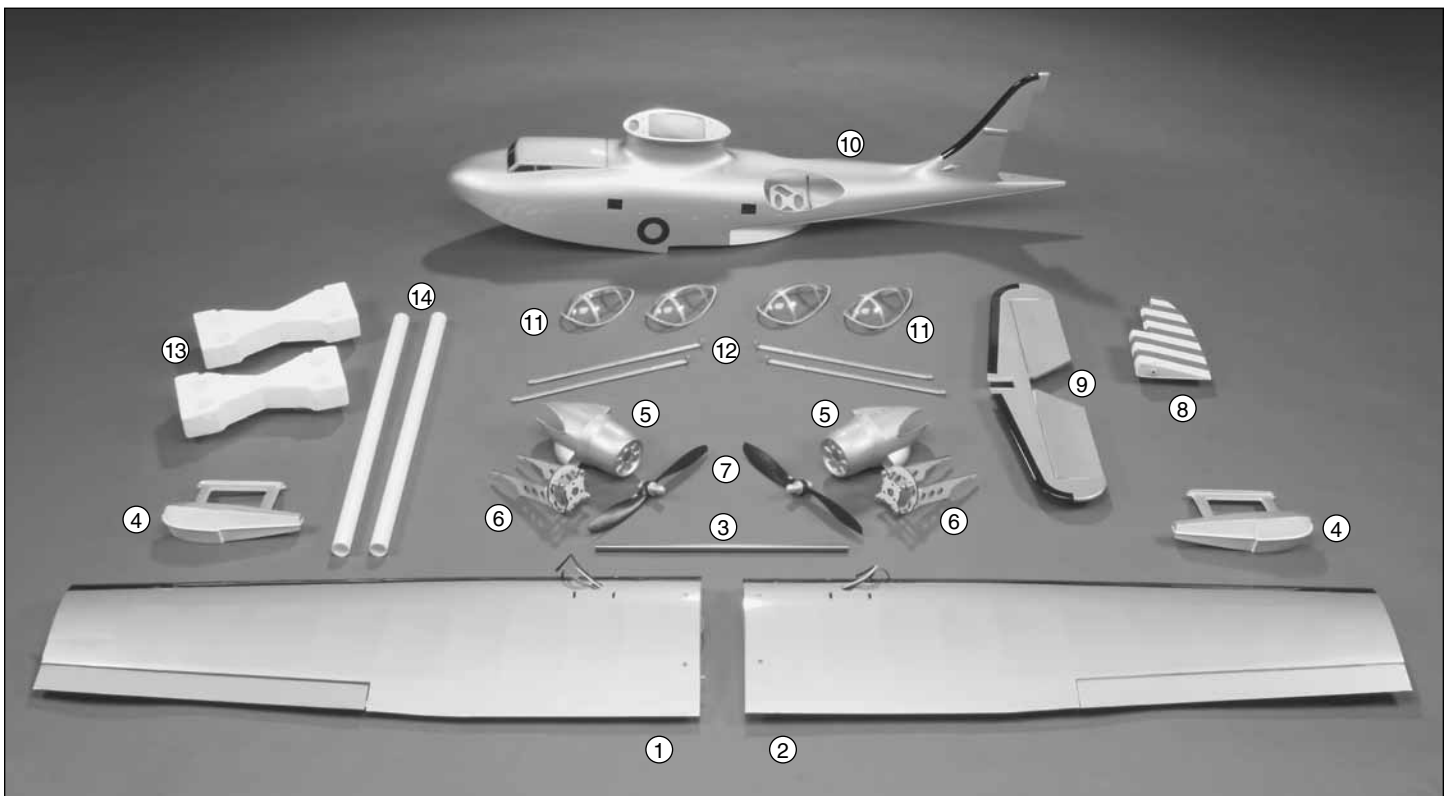

- | | |
|-------------------------------|-----------------------------|
| 1. Left Wing with Aileron | 8. Rudder |
| 2. Right Wing with Aileron | 9. Stabilizer and Elevators |
| 3. Wing Joiner | 10. Fuselage |
| 4. Tip Floats (2) | 11. Blisters (4) |
| 5. Nacelles (2) | 12. Wing Struts (4) |
| 6. Motor Mounts (2) | 13. Foam Stand Cradles (2) |
| 7. Prop and Prop Adapters (2) | 14. Stand Tubes (2) |

PREPARATIONS

❑ 1. If you have not done so already, remove the major parts of the kit from the box and inspect for damage. If any parts are damaged or missing, contact Product Support at the address or telephone number listed in the “Kit Inspection” section on page 5.

❑ 2. Carefully remove the tape and separate the ailerons from the wing and the elevators from the stab. Use a covering iron with a covering sock on low to medium heat to tighten the covering if necessary. Apply pressure over sheeted areas to **thoroughly** bond the covering to the wood.

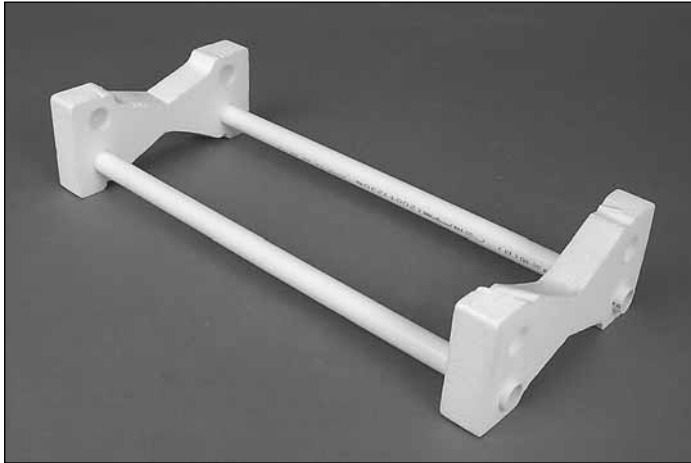

❑ 3. Your kit includes a stand that can be used during the assembly process and as a useful tool for transporting the airplane. Slide the tubes into the foam cradles as shown.

ASSEMBLE THE WING

Assemble the right wing first so your work matches the photos.

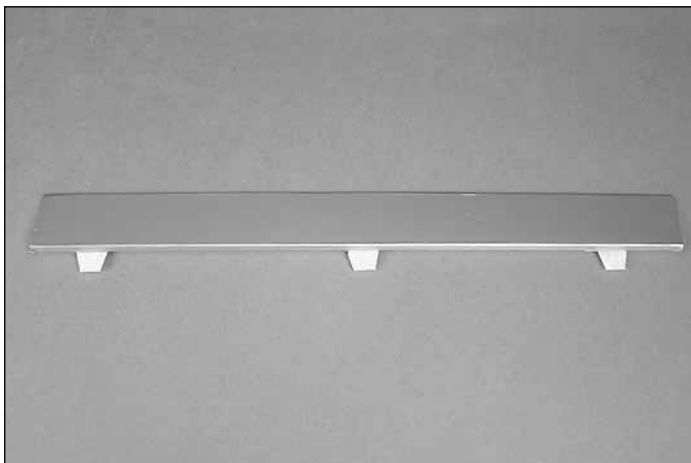

❑❑ 1. Insert a hinge into each of the three hinge slots in the **aileron**.

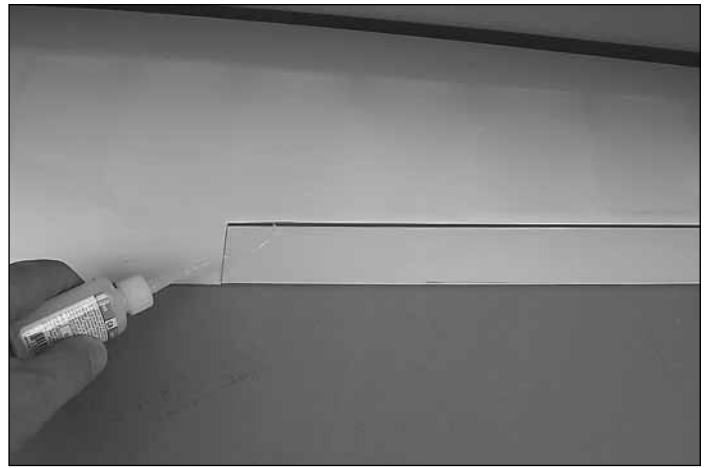

❑❑ 2. Insert the hinges and aileron into the slots in the trailing edge of the **wing**. Adjust the aileron so there is a small gap between the LE of the aileron and the wing. The gap should be small, just enough to see light through or to slip a piece of paper through. Be sure the aileron moves freely up and down. Once you are satisfied with the positioning of the aileron, apply a couple of drops of thin CA to the top and bottom of each hinge. Do not use CA accelerator. After the CA has fully hardened, test the hinges by pulling on the aileron.



❑❑ 3. A servo extension has been pre-installed in the wing and is taped to the wing just outside of the servo opening. Untape the extension from the wing and remove the protective wrapping from the connector. (**Note:** *The connector matches Futaba connectors but can be used with many other brand servos as well. Check to be sure your connector wires match the wires of this connector before using it. If you feel it is necessary to replace the extension with one of your brand, tie a string to one end of the connector before removing it from the wing. After removing the extension the string can be used to pull the new extension through the wing.*) Plug your servo into the extension. Secure the servo lead to the extension with tape, a piece of shrink tube or some other method to keep them from coming unplugged.

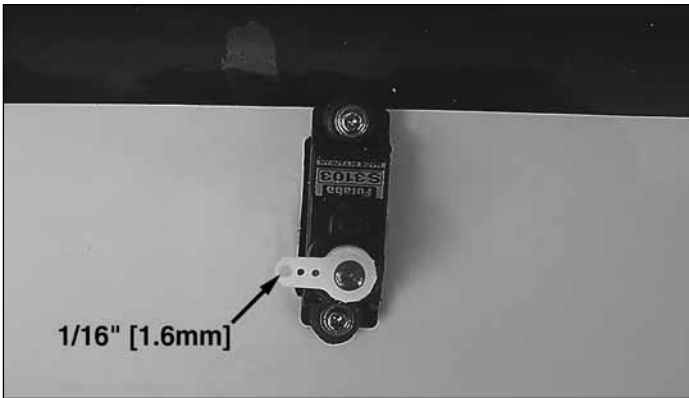

□ □ 4. Insert the servo into the opening as shown. Drill a 1/16" [1.6mm] hole through each of the servo mounting holes and into the servo mounting rails. Insert and remove a servo mounting screw into each of the holes. Apply a couple drops of thin CA into the holes to harden the threads. Once the glue has cured re-install the servo mounting screws. (**Note:** *Futaba mounting screws will work following our instruction. If you are using a different brand servo, check the screw diameter to be sure a 1/16" [1.6mm] hole will work.*) Using the servo hardware, enlarge the third hole in your servo arm with a 1/16" [1.6mm] drill.

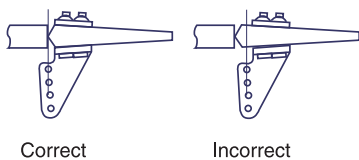
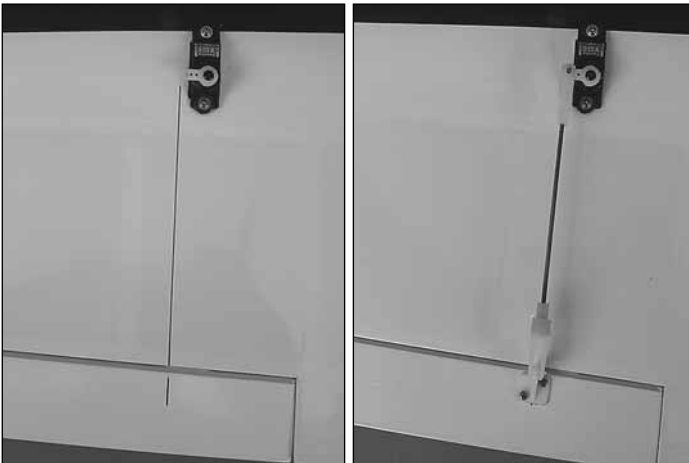

□ □ 5. Make a mark aligned with the hole in the servo arm onto the aileron. Position the control horn on the mark. Then drill a 1/16" [1.6mm] hole through each of the mounting holes in the control horn and through the aileron. Secure the control horn to the aileron with two 2 x 10mm [3/8"] screws and the nylon control horn plate. Screw a nylon clevis onto the threaded wire 20 turns. Slide a nylon clevis retainer onto the clevis. Install the clevis into the second hole from the end of the control horn. Then slide the silicone retainer over the clevis. Center the servo and position the servo arm as shown, and then center the aileron. With a fine tip marker, mark the wire where it aligns with the outer hole of the servo arm. Make a 90 degree bend on the mark. Cut the wire so the wire is 3/8" [10mm] in length after the bend. Insert the wire into the servo arm and lock it in place with a nylon Faslink.

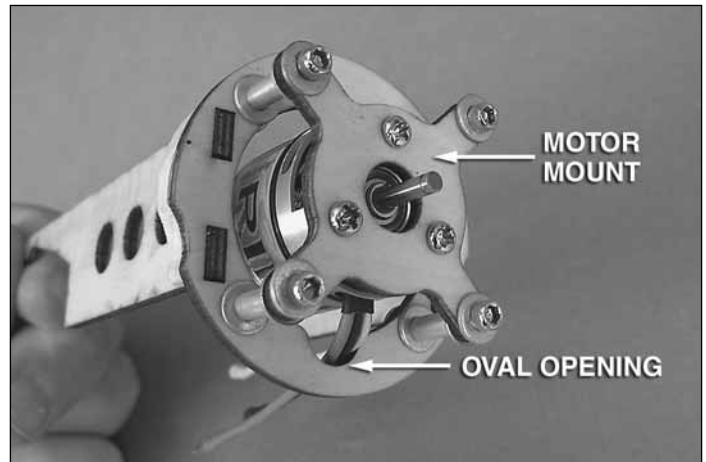
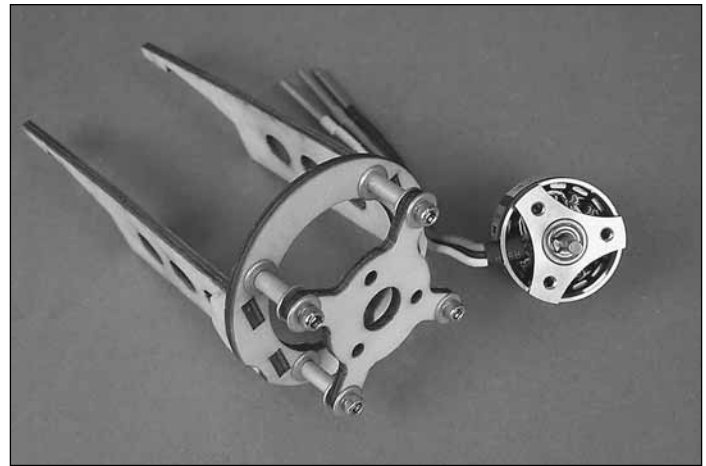

□ □ 6. Locate one of the pre-assembled motor mount assemblies. Remove any mounting hardware that may have come with your motor. Mount the motor to the motor mount with three 3mm screws (the screws that came with your motor may not be long enough to allow for the use of a washer and lock washer. If the screw head is fairly large you may not need a washer. If you wish to use washers you will need to purchase 3 x 6mm [1/4"] screws, 3mm washers and lock washers. **IMPORTANT! If you use screws longer than 6mm [1/4"] they could extend into the motor armature. Be sure the screws do not do this or you run the risk of damage to the motors.** To provide clearance for the motor wires, orient the motor on the mount so the motor wires are in line with the oval opening on the mounting ring. **Apply a drop of thread locker onto each of the mounting screws.** Check all of the socket head cap screws used on the motor mount assembly for tightness. If you find any of them are loose, remove the screw, apply a drop of thread locker to the threads and re-tighten the screws.

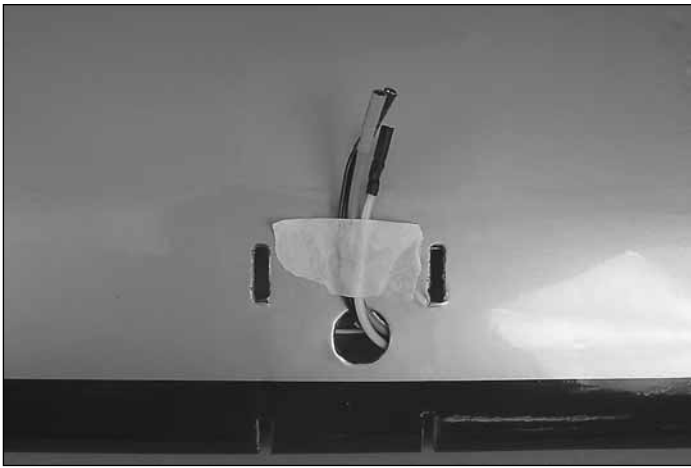

☐☐ 7. Remove the protective covering from the three wires that exit the hole in the top of the wing and tape them to the wing to prevent them from falling into the wing.

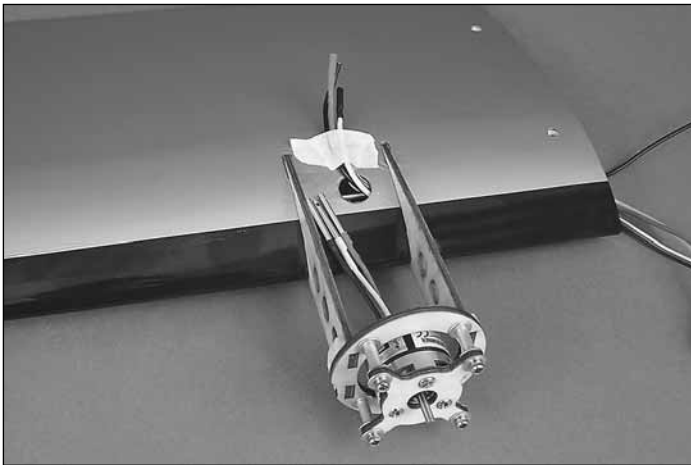

☐☐ 8. Test fit the motor mount assembly to the wing. When satisfied with the fit, glue the motor mount assembly to the wing.

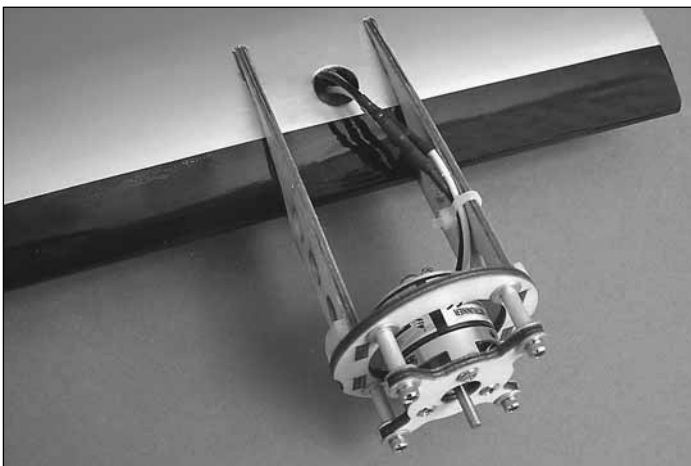

☐☐ 9. From the 4 x 100mm (4") heat shrink tubing cut three 13mm (1/2") lengths. Slide one onto each of the three motor wires. Plug the color coded motor wires into the extensions. Slide the heat shrink over the connection, making sure the heat shrink covers the brass connectors in a way that will not allow any metal to metal contact. Then shrink the tubing. Secure the wires to the wood motor mount with a small tie wrap.

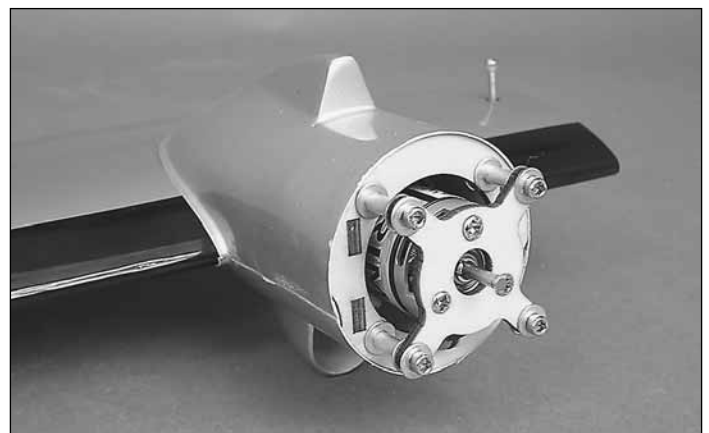
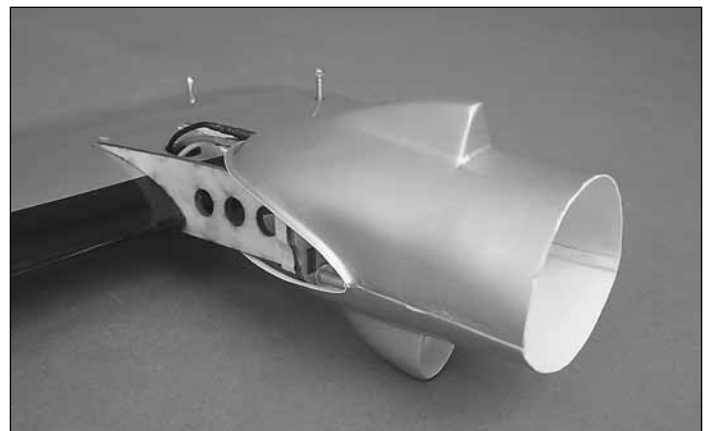
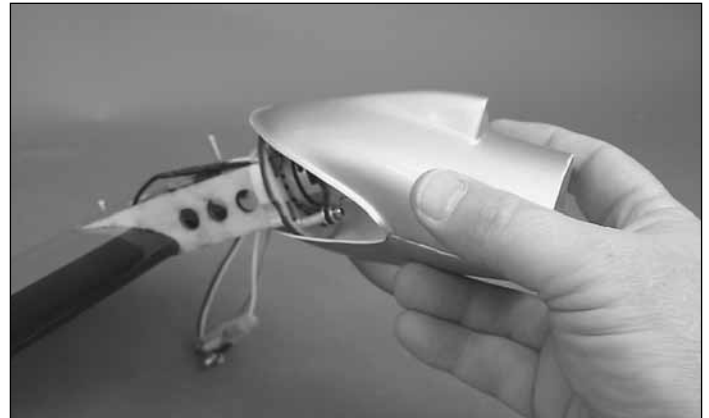
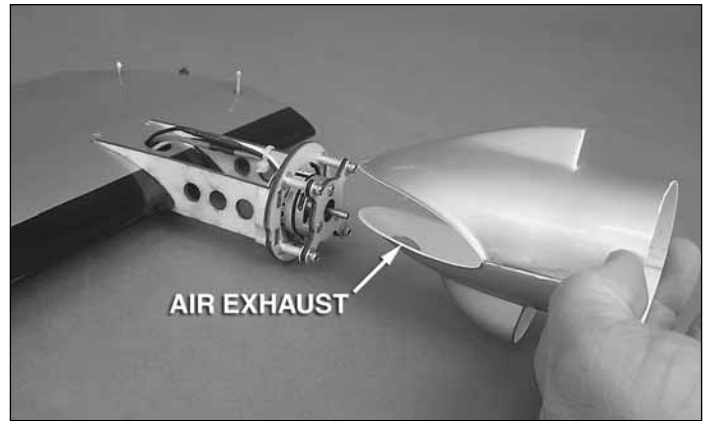

☐☐ 10. Carefully fit the nacelle over the motor mount. It is a tight fit so move slowly and cautiously. It will fit! When installing the nacelle be sure the small hole for air exhaust is located to the bottom of the nacelle. The nacelle can be secured to the wing with a small amount of glue or a piece of clear tape.

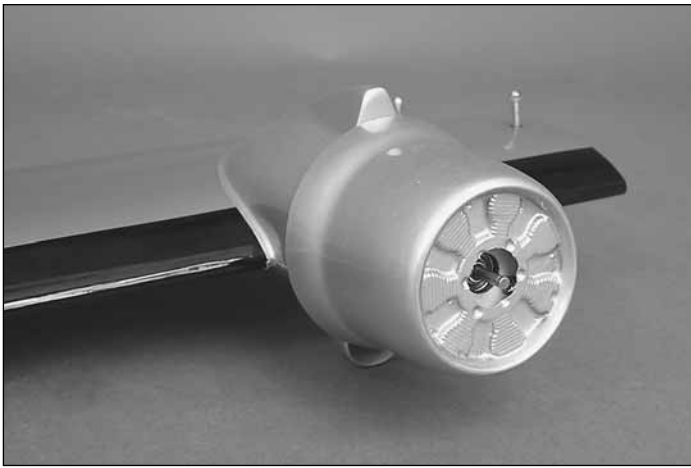

☐☐ 11. Fit the cowl, centering it over the motor shaft. The cowl should be snug enough to remain in place without any glue. If you wish, you can glue it in place before flight.

☐☐ 12. Do not install the props at this time. You will be instructed to check the motor operation later in the manual and told when to install the props.

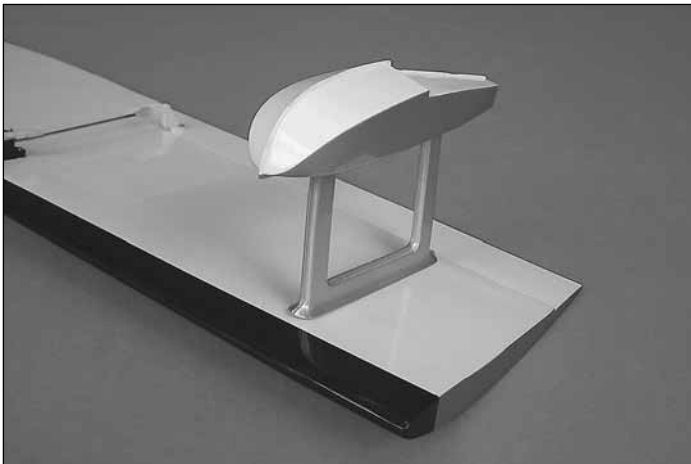

☐☐ 13. Securely epoxy the tip floats into the slots in the bottom of the wing.

☐ 14. Repeat steps 1-14 for the left wing.

ASSEMBLE THE FUSELAGE

Install the Stab, Elevators and Rudder

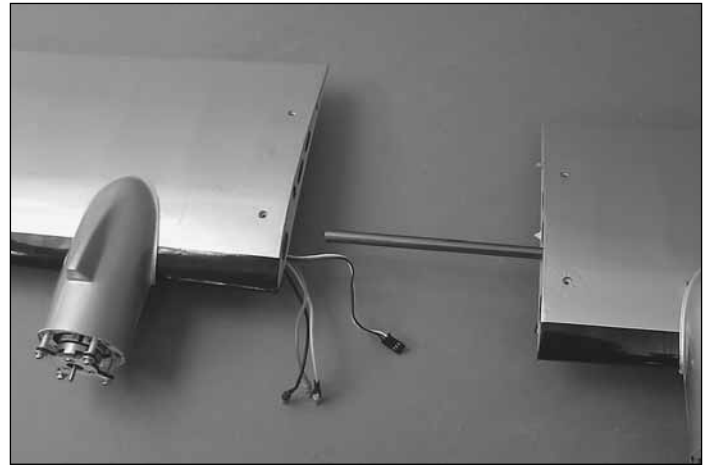

☐ 1. Insert the aluminum **wing joiner tube** into one of the wing halves. Slide the remaining wing half onto the tube and push the wing together so that the alignment pin at the back of the wing slides into the other wing panel. Temporarily install the wing to the top of the fuselage using two 4-40 x 1-1/4" [32mm] socket head cap screws in the front mounting holes and two 4-40 x 3/4" [19mm] socket head cap screws in the rear mounting holes. When installing the wing be sure all of the wires fit between the mounting screws and fit into the fuselage.

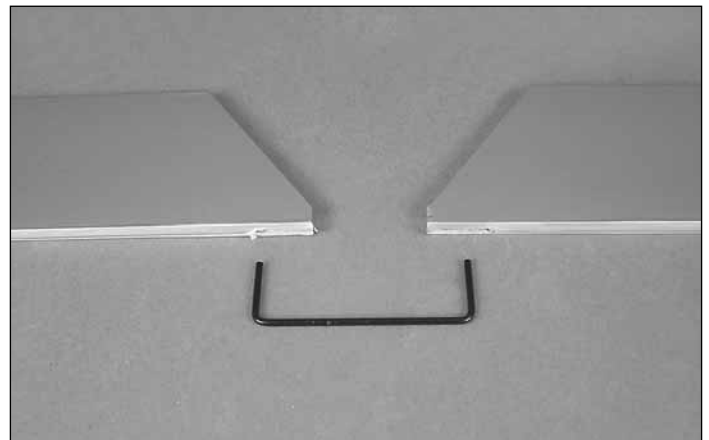

☐ 2. Locate the horizontal stabilizer, two elevator halves and the elevator joiner wire. Test fit the joiner wire into the holes and slot in the trailing edge of the elevators. Look at the alignment of the elevators. If they are not aligned with each other, make small adjustments to the joiner wire until the two elevator halves are aligned.

☐ 3. When you are satisfied with the fit and alignment, epoxy the wire to the elevator halves.

☐ 4. Using the same technique used for installing the ailerons, install three hinges into each half of the elevator. Then slide the elevator into the stab. Apply a couple of drops of thin CA to the top and bottom of each hinge. Allow the glue to harden before moving on to the next step.

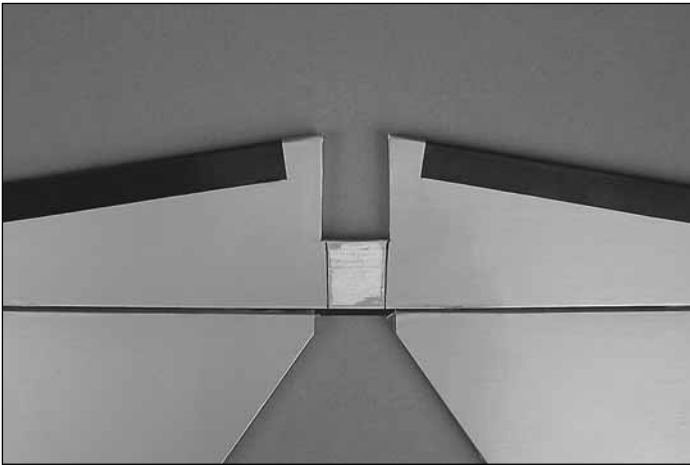
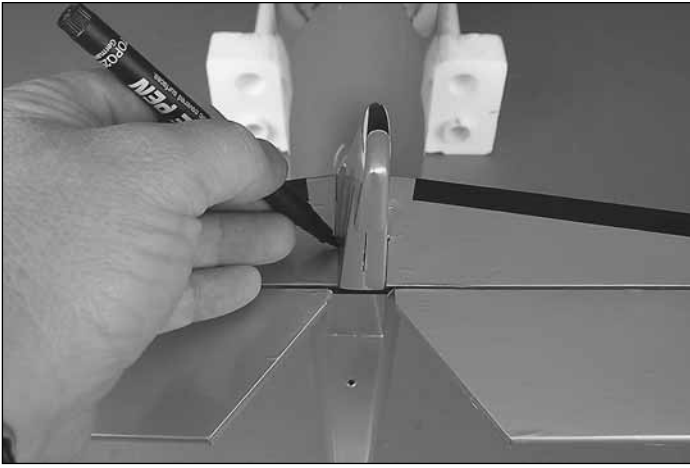

❑ 5. Place the stab into position on the back of the fuselage. Trace the shape of the fuselage to the top of the stab with a fine felt-tip pen. Cut the covering between the lines you have drawn. **Be careful not to cut through the covering. Cutting the wood will weaken the structure!**



❑ 6. Turn the fuselage upside-down. Test fit the stab to the fuselage. Be sure the stab is aligned with the wing. When you are satisfied with the fit, glue the stab to the fuselage.

❑ 7. Install a single hinge into the slot in the leading edge of the rudder. Then slide the rudder in place onto the fuselage.

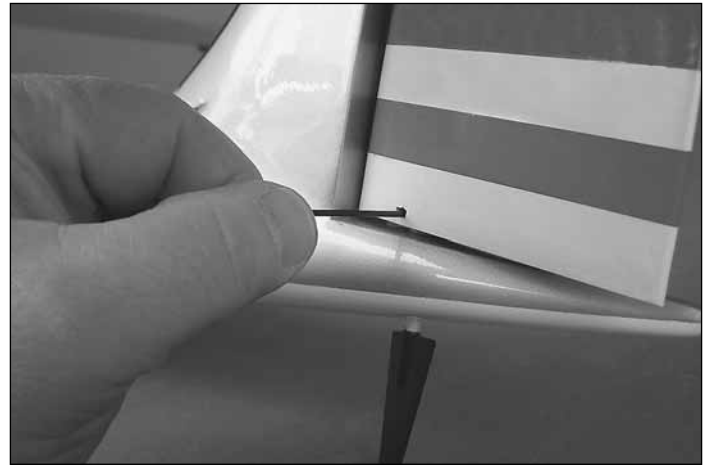
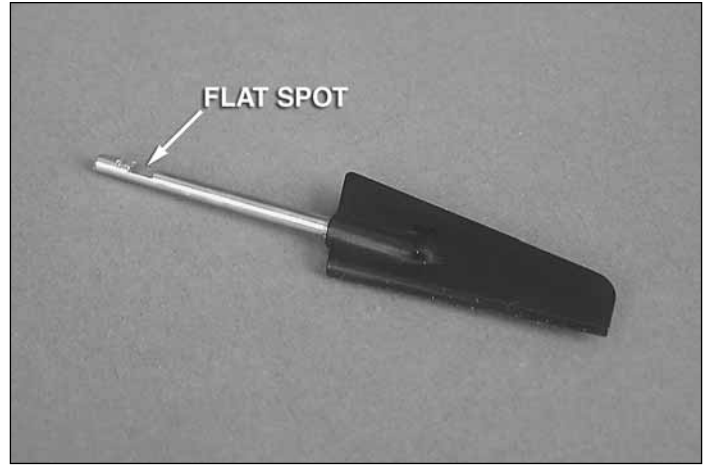

❑ 8. Locate the **water rudder** and notice the flat spot on the side of the wire. The rudder wire will serve as the hinge for the lower half of the rudder. Slide the water rudder into the hole in the bottom of the fuselage and into the hole in the bottom of the rudder. Using the included allen wrench, tighten the set screw located on the lower left side of the rudder. Apply thread locker and be sure the set screw is tightened against the flat spot of the rudder. Move the rudder, making sure it moves freely. Then apply a couple of drops of thin CA to both sides of the rudder hinge you previously installed. Set it aside until the glue hardens.

***After the glue has hardened,
remove the wing from the fuselage.***

Install the Elevator and Rudder Servos and Pushrods

❑ 1. For both the rudder and elevator servo install a servo extension onto the servo lead. With the Futaba 3103 servo a 6" [152mm] extension is adequate. Other brands may require a longer or shorter extension. To reach the receiver you need 9" [230mm] of wire from the servo to the receiver. Secure the servo lead to the extension with tape, a piece of shrink tube or some other method to keep them from coming unplugged.

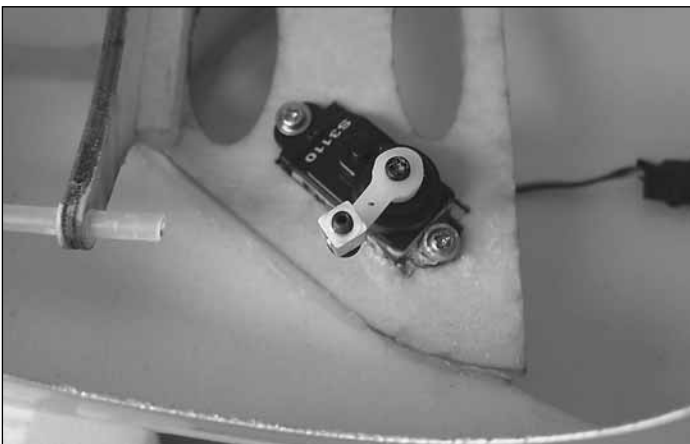
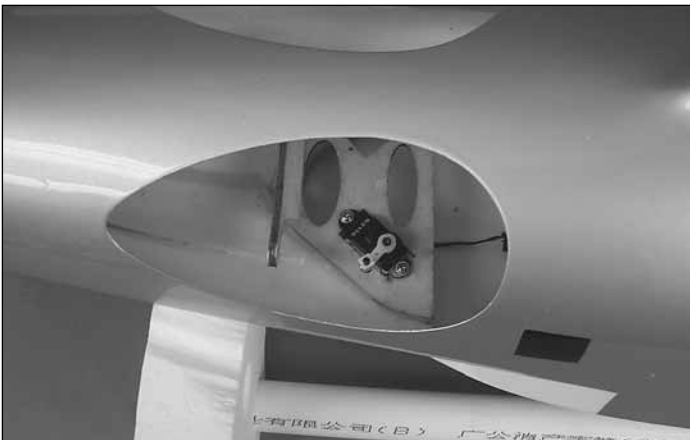
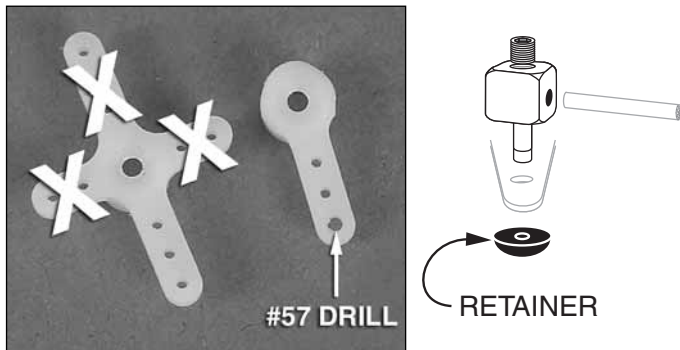

❑ 2. Remove three of the four arms from the servo horn, leaving the longest arm in place. Enlarge the last hole in the servo arm with a #57 drill. Install an aluminum screw lock connector into the hole and lock it in place with a nylon retainer. Install a set screw into the screw lock connector. Install the servo into the opening on the right side of the fuselage using the hardware that came with the servo. Center the servo and install the servo arm as shown.

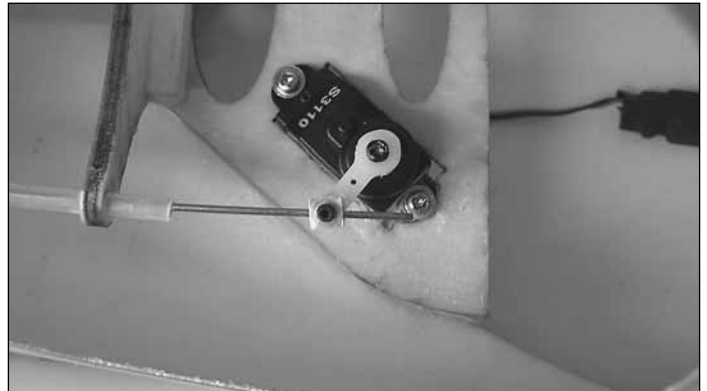

❑ 3 Install one of the .95 x 360mm [14"] long pushrod wires into the left side of the fuselage, sliding it into the servo compartment. Slide the wire into the hole in the screw lock connector and lightly tighten the set screw against the wire.



❑ 4. Install a screw lock connector into the outer hole of a control horn. Slide the screw lock connector onto the pushrod wire. Position the control horn as shown, mark the

location of the mounting holes and then drill a 1/16" [1.6mm] hole through each of the marks and through the elevator. Secure the control horn to the aileron with two 2 x 10mm [3/8"] screws and the nylon control horn plate.

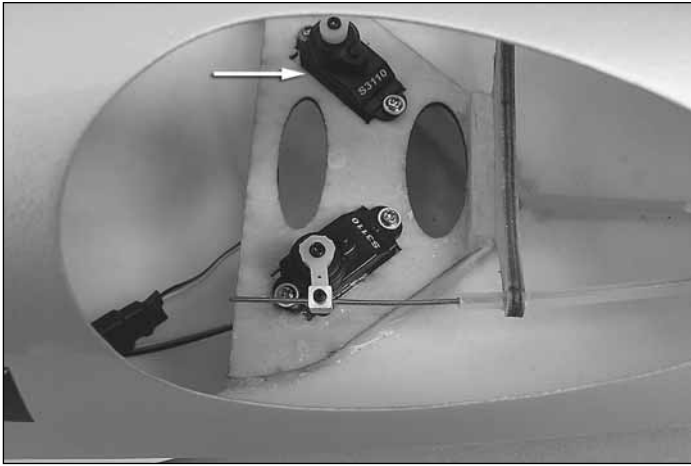

❑ 5. Install a servo into the other servo opening in the servo tray. Remove three of the four arms from the servo horn leaving the longest arm in place. Enlarge the last hole in the servo arm with a #57 drill. Install an aluminum screw lock connector into the hole and lock it in place with a nylon retainer. Install a set screw into the screw lock connector. Install the servo into the opening on the right side of the fuselage using the hardware that came with the servo. Center the servo and install the servo arm as shown.

❑ 6 Install the remaining .95 x 360mm [14"] long pushrod wires into the right side of the fuselage, sliding it into the servo compartment. Slide the wire into the hole in the screw lock connector and lightly tighten the set screw against the wire.

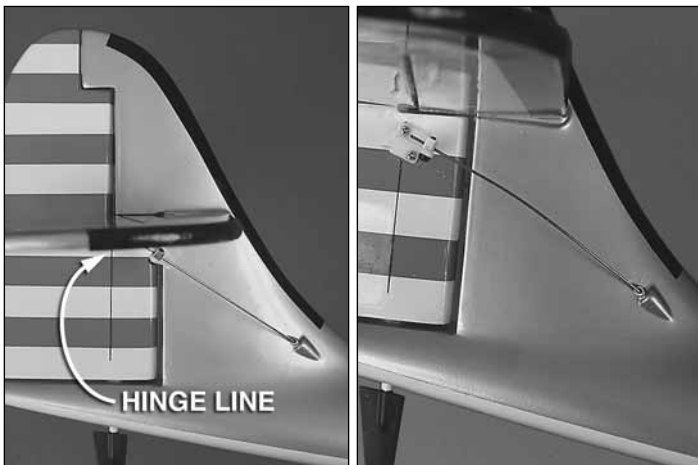

❑ 7. Install a screw lock connector into the outer hole of a control horn. Slide the screw lock connector onto the pushrod wire. Examine this picture, taking note of the hinge line of the rudder. Then position the control horn so the outer mounting hole is in line with the hinge line. Mark the location of the mounting hole. Then drill a 1/16" [1.6mm] hole through each of the marks and through the rudder. Secure the control horn to the aileron with two 2 x 25mm [1"] screws and the nylon control horn plate.

Install the Speed Control, Receiver and Batteries

❑ 1. From the adhesive hook and loop material provided with the kit, cut a piece large enough to fit the back of your receiver. Adhere one side of the hook and loop to the receiver and the other side to the plywood receiver mounting tray located inside the fuselage in the wing pod.

❑ 2. Cut the 24" [610mm] plastic antenna tube to a length of 18" [457mm]. Insert the receiver antenna into the tube.



❑ 3. Install the receiver onto the hook and loop material you installed and place the antenna tube along the side of the fuselage, securing it with a couple of drops of glue to the fuselage.

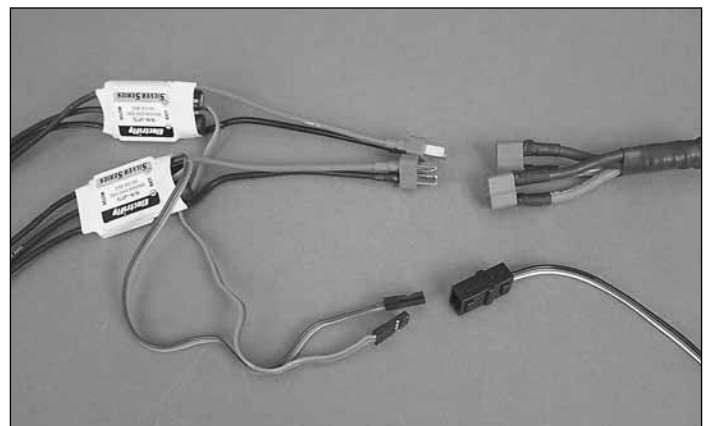

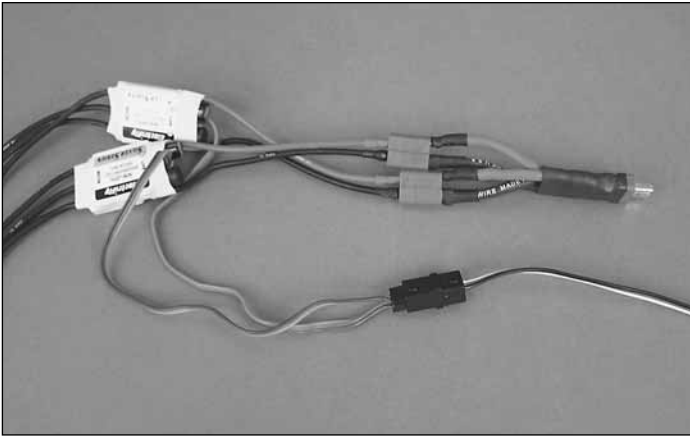

❑ 4. Plug the battery lead from your two speed controls into the “Y”connector (your “Y” connector may look different than the one pictured) and plug the two receiver leads into a servo “Y” connector. Secure the servo lead to the extension with tape, a piece of shrink tube or some other method to keep them from coming unplugged.

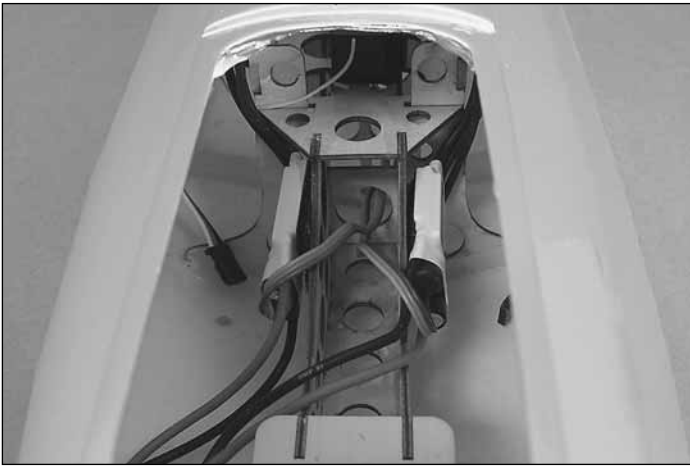

❑ 5. From the adhesive hook and loop material provided with the kit, cut a piece large enough to fit the back of your speed controls. Adhere one side of the hook and loop to the speed controls and the other sides to the side of the plywood structure inside of the fuselage. Attach the speed controls to the hook and loop material as shown.



❑ 6. Pull the wires from the speed control through the forward hole in the top of the fuselage.

❑ 7. Install a “Y” harness into the aileron port of the receiver. Then feed the wire through the forward hole with the speed control wires.

IMPORTANT: Before experimenting with different battery combinations and connecting multiple battery packs with adapter plugs, refer to the Battery Precautions on page 15.

❑ 8. Temporarily place your motor/ receiver battery onto the plywood tray inside of the fuselage. ***If you have propellers or prop adapters installed on the motors, remove them!***

❑ 9. Without attaching the wing to the fuselage, plug the wires from the motor into the wires from the speed control, following the instructions that came with your speed control.

❑ 10. Read the instructions that came with your speed control to become familiar with the connections and the motor arming sequence. Once you are familiar with the operation of the speed control turn on your transmitter. Plug the motor/receiver battery into the “Y” connector from the speed control. Follow the sequence for arming the motors from the speed control instructions. Slowly advance the throttle and be sure that both motor shafts are turning counter clockwise when viewed from the front of the airplane. If either of the motors is not turning the correct direction, shut the motors down using the throttle control on the transmitter. Unplug any two of the three wires from the speed control and reverse the connection. This will allow the motor to turn the proper direction. When you are sure both motors are turning the correct direction, unplug the battery from the speed controls and then turn off the transmitter.

❑ 11. Use a small piece of masking tape to identify each of the speed control wires so that you can unplug them and later identify the proper sequence for plugging them in. Once this is complete unplug the motors from the speed controls and set the wing aside.



❑ 12. From the adhesive hook and loop material provided with the kit, cut a piece large enough to secure your battery pack to the battery tray. Adhere one side of the hook and loop to the battery and the other side to the plywood battery tray. When you install the battery it will be held in place by both the hook and loop attached to the battery tray as well as the hook and loop strap pre-installed around the battery tray.

FINAL ASSEMBLY

Complete the Radio Installation

1. Plug the elevator and rudder servo into the appropriate channels in the receiver. Plug the motor wires into the speed control and plug the ailerons into the "Y" connector. Plug the aileron "Y" connector and the speed control into the appropriate channels in the receiver.

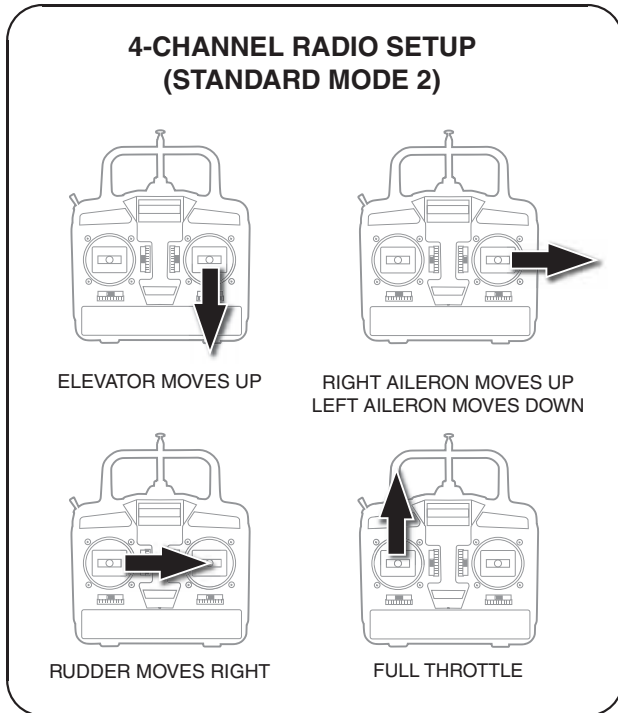

2. Place the flight battery into the battery tray. Turn on the transmitter and then plug the flight battery into the speed controls. **Do not arm the motors!** With the radio on and all control surfaces functioning, make certain that the control surfaces and the throttle respond in the correct direction as shown in the diagram. If any of the controls respond in the wrong direction, use the servo reversing in the transmitter to reverse the servos connected to those controls. Be certain the control surfaces have remained centered. Adjust if necessary. You should make any adjustments to the servos and the servo arms **now**. In a future step you will be installing the blisters over the openings in the fuselage, making adjustments to the servos difficult.

3. Make all of the connections for the ailerons and the motors. Then mount the wing to the fuselage. Make any adjustment required to the aileron and double check to be sure the motors are running the correct direction. Disconnect the battery and turn off the transmitter.

Finishing Touches



1. Locate the fuselage plug and insert it into the hole in back of the step of the fuselage. After each flight it is a good idea to remove the plug and drain any water that may have gotten into the fuselage.

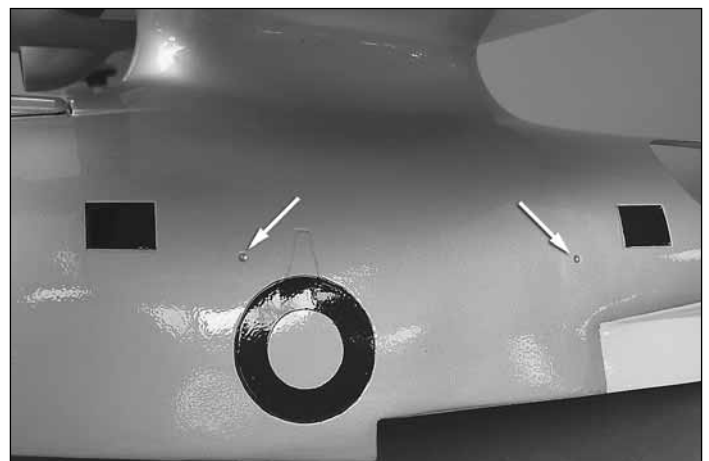

2. On both sides of the fuselage are mold dimples. On each of the dimples drill a 1/16" [1.6mm] hole through the fuselage.

3. Install a strut into each of the holes with a 2 x 10mm [3/8"] washer head screw. When installing the screw do not push too hard against the fuselage causing it to buckle. If necessary support the fuselage by putting one hand inside of the fuselage for support.



❑ 4. After installing the struts to the fuselage turn the airplane upside-down. Align the struts on the wing making sure that the strut rests on the wood sheeting, not the open wing structure. Carefully drill a 1/16" [1.6mm] hole in the **bottom** of the wing but **do not drill through the top of the wing!**

❑ 5. Insert and then remove a 2 x 10mm [3/8"] washer head screw into each of the holes. Apply a couple of drops of thin CA into each hole. After the glue has dried install the screws into the strut and wing.

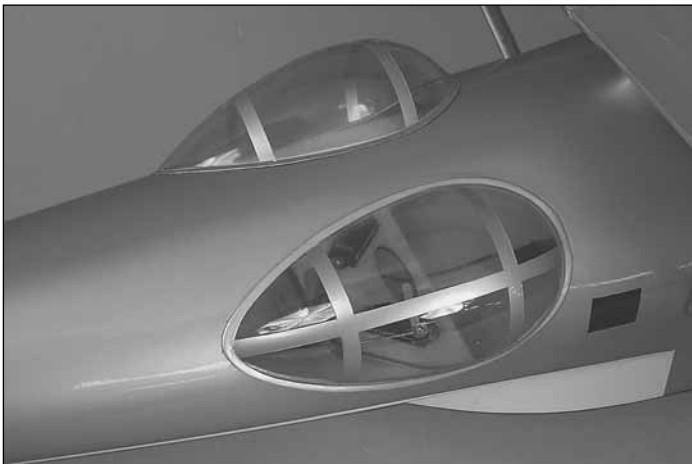

❑ 6. Your kit comes with four plastic blisters. Two are extra and should be saved if the time should come that you need to gain access to the servos and removal of the original blisters makes them unusable. Apply a bead of RC 56 canopy glue around the entire opening of the fuselage. (We recommend this glue because it dries completely clear, is water resistant and after the glue has dried it is easily separated from the item it holds in place with a hobby knife or hobby putty knife.) Hold the blisters in place with masking tape until the glue has dried. Clean any excess glue from the fuselage with a damp cloth before the glue dries.

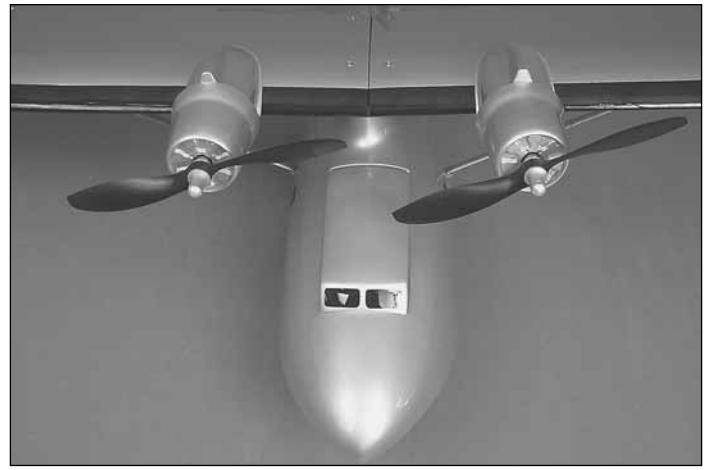

❑ 7. Install the prop adapters and propellers to the motor shaft.

❑ 8. Cut out and apply decals as shown on the box cover.

GET THE MODEL READY TO FLY

Install and Connect the Motor Battery

Before you can power the radio system and set up the controls, the motor batteries will need to be charged. Charge the batteries, and then read the following precautions on how to connect multiple packs for flying the model.

If you wish to use two smaller capacity 11.1V batteries, this is how to connect them:

*These two 1500mAh batteries (both 11.1V) are being joined in **PARALLEL**. The result will be one **11.1V, 3000mAh** battery.*

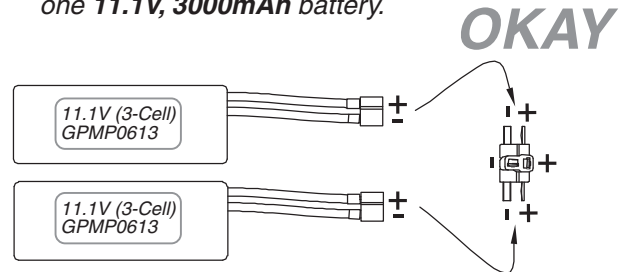

*This is a **PARALLEL** battery adapter (GPMM3142) that connects two batteries in series.*

Connecting batteries in "**Parallel**" means to connect the +’s to the +’s and the -’s to the -’s. This combines the batteries’ capacities, but the voltage remains the same.

NO!!!

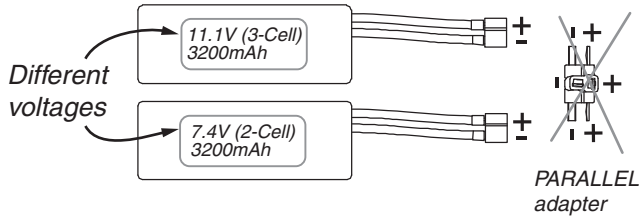

NEVER connect battery packs with different voltages in parallel. Otherwise, the batteries will try to “equalize” with the larger one trying to “charge” the smaller one, thus causing heat and likely a fire.

NO!!!

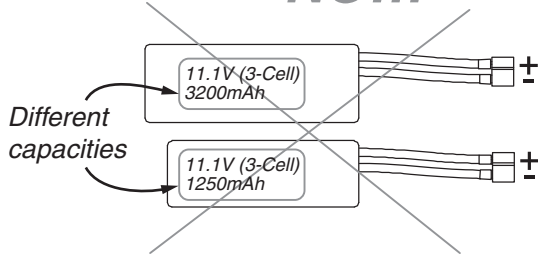

Also, **NEVER** connect battery packs with different capacities in parallel.

Set the Control Throws

Use a Great Planes AccuThrow (or a ruler) to accurately measure and set the control throw of each control surface as indicated in the chart that follows. If your radio does not have dual rates, we recommend setting the throws at the low rate setting. NOTE: The throws are measured at the widest part of the elevators, rudder and ailerons.

These are the recommended control surface throws:

	High Rate	Low Rate
ELEVATOR:	1/2" [13mm] up 1/2" [13mm] down	5/16" [8mm] up 5/16" [8mm] down
RUDDER:	3/4" [19mm] left 3/4" [19mm] right	3/8" [10mm] left 3/8" [10mm] right
AILERONS:	3/8" [10mm] up 3/8" [10mm] down	1/4" [6mm] up 1/4" [6mm] down

IMPORTANT: The PBY Catalina has been **extensively** flown and tested to arrive at the throws at which it flies best. Flying your model at these throws will provide you with the greatest chance for successful first flights. If, after you have become accustomed to the way the PBY Catalina flies, you would like to change the throws to suit your taste, that is fine. However, too much control throw could make the model difficult to control, so remember, “more is not always better.”

Balance the Model (C.G.)

More than any other factor, the **C.G.** (balance point) can have the **greatest** effect on how a model flies, and may determine whether or not your first flight will be successful. If you value this model and wish to enjoy it for many flights, **DO NOT OVERLOOK THIS IMPORTANT PROCEDURE.** A model that is not properly balanced will be unstable and possibly unflyable.

At this stage the model should be in ready-to-fly condition with all of the systems in place.

1. Use a felt-tip pen or 1/8" [3mm]-wide tape to accurately mark the C.G. on the bottom of the wing near the center pod on both sides of the fuselage. **The C.G. is located 2-1/8" [54mm] back from the leading edge of the wing.**

This is where your model should balance for the first flights. Later, you may wish to experiment by shifting the C.G. up to 1/8" [3mm] forward or 1/8" [3mm] back to change the flying characteristics. Moving the C.G. forward may improve the smoothness and stability, but the model may then require more speed for takeoff and make it more difficult to slow for landing. Moving the C.G. aft makes the model more maneuverable, but could also cause it to become too difficult to control. In any case, **start at the recommended balance point** and do not at any time balance the model outside the specified range.

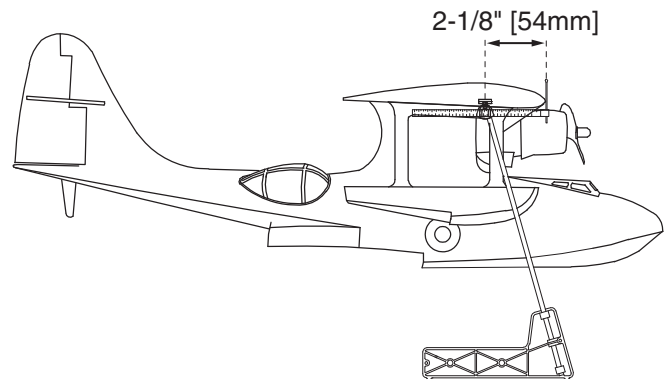

2. With the wing attached to the fuselage and all parts of the model installed (ready to fly), place the model on a Great Planes CG Machine, or lift it at the balance point you marked.

3. If the tail drops, the model is “tail heavy” and the battery pack and/or receiver must be shifted forward or weight must be added to the nose to balance. If the nose drops, the model is “nose heavy” and the battery pack and/or receiver must be shifted aft or weight must be added to the tail to balance. If possible, relocate the battery pack and receiver to minimize or eliminate any additional ballast required. Use Great Planes (GPMQ4485) “stick on” lead. A good place to add stick-on nose weight is in the nose of the fuselage. Begin by placing incrementally increasing amounts of weight on the top of the fuse until the model balances. Once you have determined the amount of weight required, it can be permanently attached inside.

Note: Do not rely upon the adhesive on the back of the lead weight to permanently hold it in place. Over time the weight could fall off. Use RTV silicone or epoxy to permanently hold the weight in place.

4. **IMPORTANT:** If you found it necessary to add any weight, recheck the C.G. after the weight has been installed.

Balance the Model Laterally

1. With the wing level, have an assistant help you lift the model by the motor propeller shaft and the bottom of the fuse under the TE of the fin. Do this several times.

2. If one wing always drops when you lift the model, it means that side is heavy. Balance the airplane by adding weight to the other wing tip. **An airplane that has been laterally balanced will track better in loops and other maneuvers.**

PREFLIGHT

Identify Your Model

No matter if you fly at an AMA sanctioned R/C club site or if you fly somewhere on your own, you should always have your name, address, telephone number and AMA number on or inside your model. It is **required** at all AMA R/C club flying sites and AMA sanctioned flying events. Fill out the identification tag on the bottom of this page and place it on or inside your model.

Charge the Batteries

Follow the battery charging instructions that came with your radio control system to charge the batteries. You should always charge your transmitter and receiver batteries the night before you go flying, and at other times as recommended by the radio manufacturer.

This model belongs to:	
	Name
	Address
	City, State Zip
	Phone number
	AMA number

Balance Propellers

Carefully balance your propeller and spare propellers before you fly. An unbalanced prop can be the single most significant cause of vibration that can damage your model. Not only will motor mounting screws and bolts loosen, possibly with disastrous effect, but vibration may also damage your radio receiver and battery. Vibration can also cause your fuel to foam, which will, in turn, cause your motor to run hot or quit.

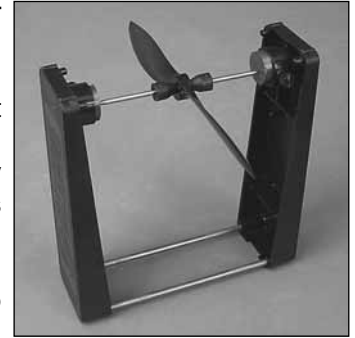

We use a Top Flite Precision Magnetic Prop Balancer (TOPQ5700) in the workshop and keep a Great Planes Fingertip Prop Balancer (GPMQ5000) in our flight box.

Range Check

Ground check the operational range of your radio before the first flight of the day. With the transmitter antenna collapsed and the receiver and transmitter on, you should be able to walk at least 100 feet away from the model and still have control. Have an assistant stand by your model and, while you work the controls, tell you what the control surfaces are doing. Repeat this test **with the motors running** at various speeds with an assistant holding the model, using hand signals to show you what is happening. If the control surfaces do not respond correctly, **do not fly!** Find and correct the problem first. Look for loose servo connections or broken wires, corroded wires on old servo connectors, poor solder joints in your battery pack or a defective cell, or a damaged receiver crystal from a previous crash.

MOTOR SAFETY PRECAUTIONS

Failure to follow these safety precautions may result in severe injury to yourself and others.

- Get help from an experienced pilot when learning to operate electric motors.
- Use safety glasses when running electric motors.
- Do not operate the motor in an area of loose gravel or sand; the propeller may throw such material in your face or eyes.
- Keep your face and body as well as all spectators away from the plane of rotation of the propeller as you operate the motor.
- Keep these items away from the prop: loose clothing, shirt sleeves, ties, scarfs, long hair or loose objects such as pencils or screwdrivers that may fall out of shirt or jacket pockets into the prop.

AMA SAFETY CODE (EXCERPTS)

Read and abide by the following excerpts from the Academy of Model Aeronautics Safety Code. For the complete Safety Code refer to *Model Aviation* magazine, the AMA web site or the Code that came with your AMA license.

General

- 1) I will not fly my model aircraft in sanctioned events, air shows, or model flying demonstrations until it has been proven to be airworthy by having been previously, successfully flight tested.
- 2) I will not fly my model aircraft higher than approximately 400 feet within 3 miles of an airport without notifying the airport operator. I will give right-of-way and avoid flying in the proximity of full-scale aircraft. Where necessary, an observer shall be utilized to supervise flying to avoid having models fly in the proximity of full-scale aircraft.
- 3) Where established, I will abide by the safety rules for the flying site I use, and I will not willfully and deliberately fly my models in a careless, reckless and/or dangerous manner.
- 5) I will not fly my model unless it is identified with my name and address or AMA number, on or in the model. Note: This does not apply to models while being flown indoors.
- 7) I will not operate models with pyrotechnics (any device that explodes, burns, or propels a projectile of any kind).

Radio Control

- 1) I will have completed a successful radio equipment ground check before the first flight of a new or repaired model.
- 2) I will not fly my model aircraft in the presence of spectators until I become a qualified flier, unless assisted by an experienced helper.
- 3) At all flying sites a straight or curved line(s) must be established in front of which all flying takes place with the other side for spectators. Only personnel involved with flying the aircraft are allowed at or in the front of the flight line. Intentional flying behind the flight line is prohibited.
- 4) I will operate my model using only radio control frequencies currently allowed by the Federal Communications Commission.
- 5) **I will not knowingly operate my model within three miles of any pre-existing flying site except in accordance with the frequency sharing agreement listed** [in the complete AMA Safety Code].
- 9) Under no circumstances may a pilot or other person touch a powered model in flight; **nor should any part of the model other than the landing gear, intentionally touch the ground, except while landing.**

CHECK LIST

During the last few moments of preparation your mind may be elsewhere anticipating the excitement of the first flight. Because of this, you may be more likely to overlook certain checks and procedures that should be performed before the model is flown. To help avoid this, a check list is provided to make sure these important areas are not overlooked. Many are covered in the instruction manual, so where appropriate, refer to the manual for complete instructions. Be sure to check the items off as they are completed.

1. Check the C.G. according to the measurements provided in the manual.
2. Be certain the battery and receiver are securely mounted in the fuse. Simply stuffing them into place with foam rubber is not sufficient.
3. Extend your receiver antenna and make sure it has a strain relief inside the fuselage to keep tension off the solder joint inside the receiver.
4. Balance your model *laterally* as explained in the instructions.
5. Use threadlocking compound to secure critical fasteners such as the set screws.
6. Make sure all hinges are **securely** glued in place.
7. Reinforce holes for wood screws with thin CA where appropriate (servo mounting screws, cowl mounting screws, etc.).
8. Confirm that all controls operate in the correct direction and the throws are set up according to the manual.
9. Secure the connections between servo wires and Y-connectors or servo extensions with tape, heat shrink tubing, or special clips suitable for that purpose.
10. Make sure any servo extension cords you may have used do not interfere with other systems (servo arms, pushrods, etc.).
11. Balance your propeller (and spare propellers).
12. Tighten the propeller nut and spinner.
13. Place your name, address, AMA number and telephone number on or inside your model.
14. If you wish to photograph your model, do so before your first flight.
15. Range check your radio when you get to the flying field.
16. Check for water and empty out before flight.
17. Make sure all screws and set screws are tight.

FLYING

The PBY Catalina is a great-flying model that flies smoothly and predictably. The PBY Catalina does not, however, possess the self-recovery characteristics of a primary R/C trainer and should be flown only by experienced R/C pilots.

CAUTION (THIS APPLIES TO ALL R/C AIRPLANES): If, while flying, you notice an alarming or unusual sound such as a low-pitched "buzz," this may indicate control surface flutter. Flutter occurs when a control surface (such as an aileron or elevator) or a flying surface (such as a wing or stab) rapidly vibrates up and down (thus causing the noise). In extreme cases, if not detected immediately, flutter can actually cause the control surface to detach or the flying surface to fail, thus causing loss of control followed by an impending crash. The best thing to do when flutter is detected is to slow the model **immediately** by reducing power, then land as soon as safely possible. Identify which surface fluttered (so the problem may be resolved) by checking all the servo grommets for deterioration or signs of vibration. Make certain all pushrod linkages are secure and free of play. If it fluttered once, under similar circumstances it will probably flutter again unless the problem is fixed. Some things which can cause flutter are; Excessive hinge gap; Not mounting control horns solidly; Poor fit of clevis pin in horn; Side-play of wire pushrods caused by large bends; Excessive free play in servo gears; Insecure servo mounting; and one of the most prevalent causes of flutter; Flying an over-powered model at excessive speeds.

Takeoff

Before placing the airplane in the water for takeoff, be sure you have plugged in the battery, armed the motors and performed a range check of the radio system. **Make sure the rubber plug is secured in the fuselage.** With everything in proper working condition, place the airplane into the water. Taxi the plane to get a feel for the handling. You will find the plane taxis well but when you begin the high speed takeoff run you need to have a light touch on the rudder. Over controlling with the rudder could result in a ground loop. When you are at high speed on the water be prepared to control the wing with the ailerons, keeping the wings level and not digging in a tip float.

Remember to takeoff directly into the wind. As the model gains speed the airplane will get up on the step and become light on the water. Be smooth on the elevator stick, allowing the model to establish a **gentle** climb to a safe altitude before turning into the traffic pattern.

Flight

For reassurance and to keep an eye on other traffic, it is a good idea to have an assistant on the flight line with you. Tell him to remind you to throttle back once the plane gets to a comfortable altitude. While full throttle is usually desirable for takeoff, this model flies more smoothly at reduced speeds.

Take it easy with the PBY Catalina for the first few flights, gradually getting acquainted with it as you gain confidence. Adjust the trims to maintain straight and level flight. After flying around for a while, and while still at a safe altitude with plenty of fuel, practice slow flight and execute practice landing approaches by reducing the throttle to see how the model handles at slower speeds. Add power to see how she climbs as well. Continue to fly around, executing various maneuvers and making mental notes (or having your assistant write them down) of what trim or C.G. changes may be required to fine tune the model so it flies the way you like. Be aware of the time spent in the air, making sure you have enough battery to land and taxi back. Use this first flight to become familiar with your model before landing.

Landing

To initiate a landing approach, lower the throttle while on the downwind leg. Allow the nose of the model to pitch downward to gradually bleed off altitude. Continue to lose altitude, but maintain airspeed by keeping the nose down as you turn onto the crosswind leg. Make your final turn toward the runway/water (into the wind) keeping the nose down to maintain airspeed and control. Level the attitude when the model reaches a couple of feet from the water, modulating the throttle as necessary to maintain your glide path and airspeed. If you are going to overshoot, smoothly advance the throttle (always ready on the right rudder to counteract torque) and climb out to make another attempt. When you're ready to make your landing flare when the model is a foot or so off the water, smoothly increase up elevator until it gently touches down.

One final note about flying your model. Have a goal or flight plan in mind for **every** flight. This can be learning a new maneuver(s), improving a maneuver(s) you already know, or learning how the model behaves in certain conditions (such as on high or low rates). This is not necessarily to improve your skills (*though it is never a bad idea!*), but more importantly so you do not surprise yourself by impulsively attempting a maneuver and suddenly finding that you've run out of time, altitude or airspeed. Every maneuver should be deliberate, not impulsive. For example, if you're going to do a loop, check your altitude, mind the wind direction (anticipating rudder corrections that will be required to maintain heading), remember to throttle back at the top, and make certain you are on the desired rates (high/low rates). A flight plan greatly reduces the chances of crashing your model just because of poor planning and impulsive moves. **Remember to think.**

Have a ball!

But always stay in control and fly in a safe manner.

GOOD LUCK AND GREAT FLYING!

Other Items Available from Great Planes

Seawind[®]

Wingspan: 71 in (1805mm)
Wing Area: 676 sq in (43.6dm²)
Weight: 10.25-12.25 lb (4.6-5.5kg)
Wing Loading: 35-41 oz/sq ft (106-127g/dm²)
Length: 56 in (1410mm)
Requires: 2-stroke .60 cu in (10cc) or 4-stroke .70-.91 cu in (11.5-15cc) engine, 5-7 channel radio w/7-9 servos

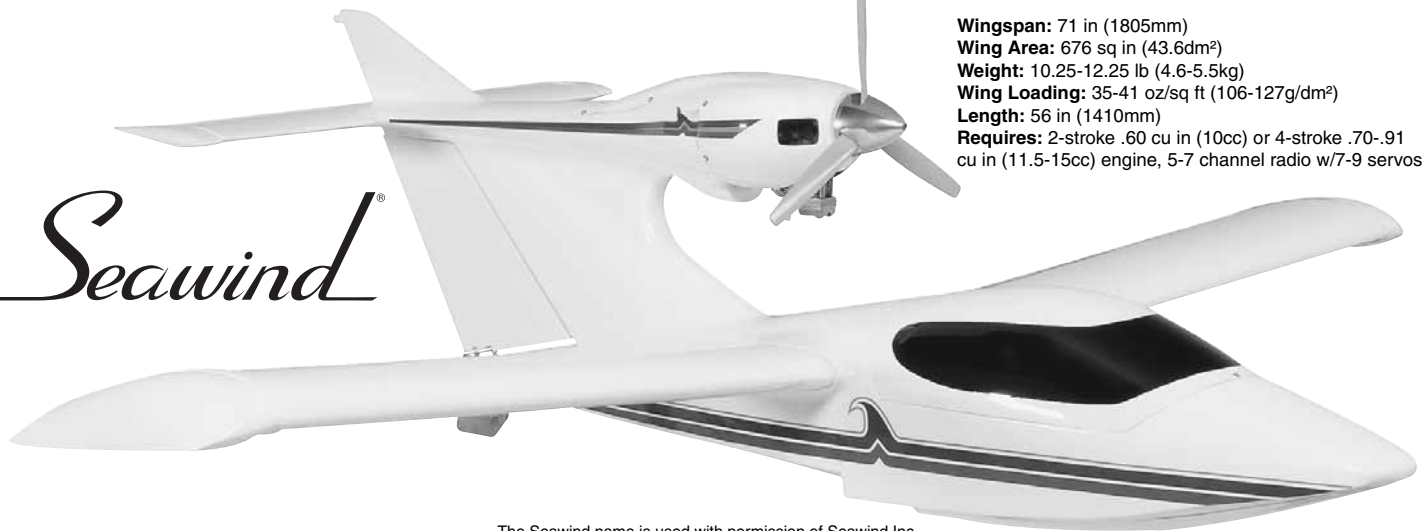

The Seawind name is used with permission of Seawind Inc.

No other R/C seaplane looks or flies like the Seawind. This sport-scale replica of the classic homebuilt amphibious aircraft draws attention wherever it's flown, whether at the flying field or the local lake. Substitute optional retracts for the included fixed landing gear and you'll be able to fly from land OR water with the same plane! The fiberglass wingtips offer excellent stability during flight and double as floats to support the Seawind on the water. Without the need for bulky suspended floats, the model flies faster than typical seaplanes. Assembly moves quickly, too. With its low number of parts, the Seawind ARF requires only 15-18 hours of building time. The fuselage and wingtips are gel-coated fiberglass. The built-up wing and tail section are made of balsa and factory-covered in MonoKote. The wing simply plugs into an aluminum joiner and is secured with nylon bolts — no tools needed. The unique boom-mounted engine design not only enhances the model's looks, but also reduces the likelihood of water "spray" reaching the engine during takeoff and landing. As your sleek Seawind ARF touches down gracefully onto the water, it hits you: this is a seaplane like no other, in both looks and performance. **GPMA1360**

ElectriFly[™]

POLYCHARGE4

FOUR-OUTPUT LITHIUM-POLYMER CHARGER



For convenience with multiple LiPo packs, there's the DC Polycharge4. Each of its four independent outputs can charge a one-to-four cell Lithium-Polymer pack. It's ideal if you don't have the time for one-at-a-time charging - and don't want the expense and hassle of multiple chargers. Each output can handle packs from 300 to 3000mAh. Set the capacity, and Polycharge4 will automatically set the charge rate to get you started — and use light and sound cues to tell you when your pack is done. **GPMM3015**

ElectriFly[™]
FOKKER D.VII



Wingspan: 36 in
Wing Area: 360 in²
Wing Loading: 10 oz/ft²
Weight: 25.7oz
Length: 27 in

Like the full-size Fokker D.VII that challenged Allied air forces in WWI, this prebuilt park flyer is a spirited performer. And because the Fokker D.VII park flyer is an ARF, the high-quality, laser-cut wood parts assemble quickly and easily. Its prebuilt balsa/ply structures are precovered in a high-quality film. Lots of impressive details are included, from the vacuum-formed cowl and realistic machine guns to the scale-shaped landing gear and scale wheels. The cabanes and interplane struts come already painted and are shaped for easy installation and proper alignment. An out-runner brushless motor gives this model a great power-to-weight ratio and long flight times. The ElectriFly RimFire 28-30-950 motor (GPMG4560) was found to be ideal for the Fokker D.VII. **GPMA1141**