

Revolver™

INSTRUCTION MANUAL



Wingspan: 59 in [1500mm]

Wing Area: 563 in² [36 dm²]

Weight: 6–7 lb [2720–3180g]

Wing Loading: 25–29 oz/ft² [76–88 g/dm²]

Radio: 4-Channel minimum with 4-5 servos and standard size receiver

Engine: .46-.55 cu in [7-9cc] two-stroke, .70 cu in [11.5cc] four-stroke,
42-60-800kV out-runner brushless motor

WARRANTY

Great Planes® Model Manufacturing Co. guarantees this kit to be free from defects in both material and workmanship at the date of purchase. This warranty does not cover any component parts damaged by use or modification. **In no case shall Great Planes' liability exceed the original cost of the purchased kit.** Further, Great Planes reserves the right to change or modify this warranty without notice.

In that Great Planes has no control over the final assembly or material used for final assembly, no liability shall be assumed nor accepted for any damage resulting from the use by the user of the final user-assembled product. By the act of using the user-assembled product, the user accepts all resulting liability.

If the buyer is not prepared to accept the liability associated with the use of this product, the buyer is advised to return

this kit immediately in new and unused condition to the place of purchase.

To make a warranty claim send the defective part or item to Hobby Services at the address below:

Hobby Services
3002 N. Apollo Dr., Suite 1
Champaign, IL 61822 USA

Include a letter stating your name, return shipping address, as much contact information as possible (daytime telephone number, fax number, e-mail address), a detailed description of the problem and a photocopy of the purchase receipt. Upon receipt of the package, the problem will be evaluated as quickly as possible.

READ THROUGH THIS MANUAL BEFORE STARTING CONSTRUCTION. IT CONTAINS IMPORTANT INSTRUCTIONS AND WARNINGS CONCERNING THE ASSEMBLY AND USE OF THIS MODEL.



Champaign, Illinois
(217) 398-8970, Ext 5
airsupport@greatplanes.com

TABLE OF CONTENTS

INTRODUCTION	2
AMA	2
SAFETY PRECAUTIONS	3
DECISIONS YOU MUST MAKE	3
Radio Equipment	3
Power System Recommendations	3
Propeller.....	3
Batteries and Charger.....	4
ADDITIONAL ITEMS REQUIRED	4
Required Hardware and Accessories	4
Adhesives and Building Supplies	4
Optional Supplies and Tools.....	4
Building Stand.....	5
IMPORTANT BUILDING NOTES	5
ORDERING REPLACEMENT PARTS	5
KIT INSPECTION	6
PREPARATIONS	7
BUILD THE WING	7
Install the Ailerons.....	7
Install the Aileron Servos and Pushrods	8
Finish the Wing Panels	10
BUILD THE FUSELAGE	11
Assemble the Tail Section	11
Install the Tail Servos and Pushrods	13
Assemble and Install the Main Landing Gear	15
INSTALL THE POWER SYSTEM.....	16
Glow Engine Installation	16
Brushless Motor Installation.....	19
FINISH THE MODEL	21
Install the Receiver	21
Install the Cowl.....	22
Prepare the Battery Trays (Brushless Only).....	23
Install the Canopy Hatch and Spinner.....	23
Apply the Decals	25
GET THE MODEL READY TO FLY	25
Install the Motor Battery (Brushless Only)	25
Check the Control Directions	26
Set the Control Throws	26
Balance the Model (C.G.).....	26
Balance the Model Laterally.....	27
PREFLIGHT	27
Identify Your Model.....	27
Charge the Batteries.....	27
Balance Propellers.....	27
Ground Check.....	28
Range Check	28
ENGINE SAFETY PRECAUTIONS.....	28
LITHIUM BATTERY HANDLING AND USAGE	28
AMA SAFETY CODE.....	29
CHECK LIST	29
FLYING.....	30
Takeoff	30
Flight	30
Landing	30

INTRODUCTION

Congratulations on the purchase of the Great Planes Revolver .46 ARF! This sport plane was designed for the average sport pilot who is looking for an airplane that looks good, flies fast, and is capable of performing a wide range of aerobatic maneuvers. Loops, rolls, positive and negative snap rolls, hammerheads, and lomcevak are all within the capabilities of this airplane. We have incorporated many features found only on larger airplanes. Things such as plug-in wings, composite landing gear, and a removable canopy for easy access to the inside of the fuselage are features you will come to appreciate.

For the latest technical updates or manual corrections to the Revolver ARF visit the Great Planes web site at www.greatplanes.com. Open the "Airplanes" link, then select the Revolver ARF. If there is new technical information or changes to this model a "tech notice" box will appear in the upper left corner of the page.

AMA

We urge you to join the AMA (Academy of Model Aeronautics) and a local R/C club. The AMA is the governing body of model aviation and membership is required to fly at AMA clubs. Though joining the AMA provides many benefits, one of the primary reasons to join is liability protection. Coverage is not limited to flying at contests or on the club field. It even applies to flying at public demonstrations and air shows. Failure to comply with the Safety Code (excerpts printed in the back of the manual) may endanger insurance coverage. Additionally, training programs and instructors are available at AMA club sites to help you get started the right way. There are over 2,500 AMA chartered clubs across the country. Contact the AMA at the address or toll-free phone number below.



Academy of Model Aeronautics

5151 East Memorial Drive

Muncie, IN 47302

Tele: (800) 435-9262

Fax (765) 741-0057

Or via the Internet at:

<http://www.modelaircraft.org>

IMPORTANT!!! Two of the most important things you can do to preserve the radio controlled aircraft hobby are to avoid flying near full-scale aircraft and avoid flying near or over groups of people.

PROTECT YOUR MODEL, YOURSELF & OTHERS...FOLLOW THESE IMPORTANT SAFETY PRECAUTIONS

1. Your Revolver ARF should not be considered a toy, but rather a sophisticated, working model that functions very much like a full-size airplane. Because of its performance capabilities, the Revolver, if not assembled and operated correctly, could possibly cause injury to yourself or spectators and damage to property.

2. You must assemble the model **according to the instructions**. Do not alter or modify the model, as doing so may result in an unsafe or unflyable model. In a few cases the instructions may differ slightly from the photos. In those instances the written instructions should be considered as correct.

3. You must take time to **build straight, true and strong**.

4. You must use an R/C radio system that is in first-class condition, and a correctly sized engine and components (fuel tank, wheels, etc.) throughout the building process.

5. You must correctly install all R/C and other components so that the model operates correctly on the ground and in the air.

6. You must check the operation of the model before **every** flight to insure that all equipment is operating and that the model has remained structurally sound. Be sure to check clevises or other connectors often and replace them if they show any signs of wear or fatigue.

7. If you are not an experienced pilot or have not flown this type of model before, we recommend that you get the assistance of an experienced pilot in your R/C club for your first flights. If you're not a member of a club, your local hobby shop has information about clubs in your area whose membership includes experienced pilots.

8. While this kit has been flight tested to exceed normal use, if the plane will be used for extremely high stress flying, such as racing, or if an engine larger than one in the recommended range is used, the modeler is responsible for taking steps to reinforce the high stress points and/or substituting hardware more suitable for the increased stress.

9. **WARNING:** The cowl and wheel pants included in this kit are made of fiberglass, the fibers of which may cause eye, skin and respiratory tract irritation. Never blow into a part to remove fiberglass dust, as the dust will blow back into your eyes. Always wear safety goggles, a particle mask and rubber gloves when grinding, drilling and sanding fiberglass parts. Vacuum the parts and the work area thoroughly after working with fiberglass parts.

We, as the kit manufacturer, provide you with a top quality, thoroughly tested kit and instructions, but ultimately the quality and flyability of your finished model depends on how you build it; therefore, we cannot in any way guarantee the performance of your completed model, and no representations are expressed or implied as to the performance or safety of your completed model.

Remember: Take your time and follow the instructions to end up with a well-built model that is straight and true.

DECISIONS YOU MUST MAKE

This is a partial list of items required to finish the Revolver .46 ARF that may require planning or decision making before starting to build. Order numbers are provided in parentheses.

Radio Equipment

The Revolver .46 ARF requires a minimum 4-channel radio system with four 50 oz.-in. [3.6 kg-cm] minimum standard servos. If you are installing a glow engine, an additional standard servo is required for the throttle.

In addition, two 6" [152mm] servo extensions are required for the aileron servos. If you are using a radio system that does not support mixing functions, a Y-harness will also be required to connect the aileron servos to the receiver.

If you plan to install a brushless motor, you will need a 6" [152mm] servo extension for the ESC. If you plan to install a glow engine, you will need a 12" [305mm] servo extension for the receiver pack.

A charge jack receptacle is optional, but is useful for recharging the receiver pack without removing the canopy hatch and is shown in the assembly of the plane. Recommended part numbers for the radio components are provided below:

- Futaba® S9001 Servo Aircraft Coreless BB (FUTM0075)
- Futaba S3003 Servo Standard (FUTM0031)
- Hobbico® Pro™ HD Extension 6" [152mm] Futaba J (HCAM2701)
- Hobbico Pro HD Y-Harness Futaba J (HCAM2751)
- Hobbico Pro HD Extension 12" [305mm] Futaba J (HCAM2711)
- Ernst Charge Receptacle Futaba J FM (ERNM3001)

Power System Recommendations

The recommended engine/motor size for the Revolver ARF is a .46-.55 cu in [7-9 cc] two-stroke engine, .70 cu in [11.5 cc] four-stroke engine, or a RimFire™ 42-60-800kV outrunner brushless motor. Engine and motor order numbers are provided below:

- O.S.® .46 AX ABL w/Muffler (OSMG0547)
- O.S.® .55 AX ABL w/Muffler (OSMG0556)
- Bisson O.S. .46 SF/FX .50 SX Pitts Muffler (BISG4046)
- Great Planes RimFire 42-60-800 Out-Runner Brushless (GPMG4725)
- Great Planes Brushless Motor Mount Medium Motors (GPMG1255)

If using the recommended brushless motor, an 80A brushless ESC is required:

- Great Planes Silver Series 80A Brushless ESC High Volt (GPMM1860)

Propeller

If you are installing a glow engine, choose a prop based on the engine manufacturer's recommendation. If you are installing the recommended RimFire brushless motor, we suggest an APC 11x5.5 Electric Propeller (APCQ1055).

Batteries and Charger

For a brushless motor installation, two 3200mAh 11.1V Lithium Polymer battery packs connected in series are recommended. Order numbers for the battery packs and series connector are provided below:

- Great Planes LiPo 3200mAh 11.1V 20C Discharge w/Balance (GPMP0623)
- Great Planes Series Deans U 2 to 1 Adapter (GPMM3143)

A cell balancer is required for the LiPo battery pack listed above:

- Great Planes ElectriFly™ Equinox™ LiPo Cell Balancer 1-5 (GPMM3160)

A suitable charger is also required. The Great Planes PolyCharge4™ is designed for LiPo packs only, but is able to charge four LiPo packs simultaneously. The Great Planes Triton2™ charger will only charge one pack at a time, but is capable of charging NiCd, NiMH, LiPo, and lead acid batteries. Order numbers for both are provided below:

- Great Planes PolyCharge4 DC Only 4 Output LiPo Charger (GPMM3015) **or** Great Planes ElectriFly Triton2 DC Comp Peak Charger (GPMM3153)

ADDITIONAL ITEMS REQUIRED

This is the list of hardware and accessories required to finish the Revolver ARF. Order numbers are provided in parentheses:

- R/C Foam Rubber (1/4" [6mm], HCAQ1000; or 1/2" [13mm], HCAQ1050)
- 3' [900mm] Standard Silicone Fuel Tubing (GPMQ4131)

Adhesives and Building Supplies

This is the list of Adhesives and Building Supplies that are required to finish the Revolver ARF:

- 1/2 oz. [15g] Thin Pro CA (GPMR6001)
- 1/2 oz. [15g] Medium Pro CA+ (GPMR6007)
- Pro 30-Minute Epoxy (GPMR6047)
- Masking Tape (TOPR8018)
- Threadlocker Thread Locking Cement (GPMR6060)
- Denatured Alcohol (for epoxy clean up)
- Drill bits: 1/16" [1.6mm], 5/64" [2mm], 3/32" [2.4mm]

- Great Planes Tap & Drill Set 6-32 (GPMR8102, Glow Engine Installation Only)
- Tap Handle (GPMR8120)
- Small Metal File
- #1 Hobby Knife (HCAR0105)
- #11 Blades (5-pack, HCAR0211)
- Medium T-pins (100, HCAR5150)
- Top Flite® MonoKote® Sealing Iron (TOPR2100)
- Top Flite Hot Sock™ Iron Cover (TOPR2175)
- 220 grit Sandpaper
- 1/2" [13mm] Double-sided Foam Mounting Tape (GPMQ4440, Brushless Installation Only)
- Microballoons (TOPR1090)
- Panel Line Pen (TOPQ2510)

Optional Supplies and Tools

Here is a list of optional tools that will help you build the Revolver ARF:

- 1/2 oz. [15g] Thick Pro CA- (GPMR6013)
- 2 oz. [57g] Spray CA Activator (GPMR6035)
- 4 oz. [113g] Aerosol CA Activator (GPMR6034)
- CA Applicator Tips (HCAR3780)
- CA Debonder (GPMR6039)
- Pro 6-Minute Epoxy (GPMR6045)
- Epoxy Brushes (6, GPMR8060)
- Mixing Sticks (GPMR8055)
- Mixing Cups (GPMR8056)
- Pliers with Wire Cutter (HCAR0630)
- Hobbico Duster Compressed Air (HCAR5500)
- Switch & Charge Jack Mounting Set (GPMM1000)
- Rotary Tool such as Dremel
- Rotary Tool Reinforced Cut-Off Wheel (GPMR8020)
- Servo Horn Drill (HCAR0698)
- Hobby Heat Micro Torch (HCAR0750)
- Dead Center™ Engine Mount Hole Locator (GPMR8130)
- Precision Magnetic Prop Balancer™ (TOPQ5700)
- AccuThrow Deflection Gauge (GPMR2405)
- CG Machine™ (GPMR2400)
- Hobbico Flexible 18" Ruler Stainless Steel (HCAR0460)
- Top Flite MonoKote Trim Seal Iron (TOPR2200)
- Top Flite MonoKote Heat Gun (TOPR2000)
- Hobbico Pin Vise 1/16 Collet w/6 Bits (HCAR0696)
- Hobbico 8-Piece Ball Tip Hex L Wrench SAE (HCAR0520)
- Hobbico 7-Piece Ball Tip Hex L Wrench Metric (HCAR0521)
- Great Planes Clevis Installation Tool (GPMR8030)

Building Stand

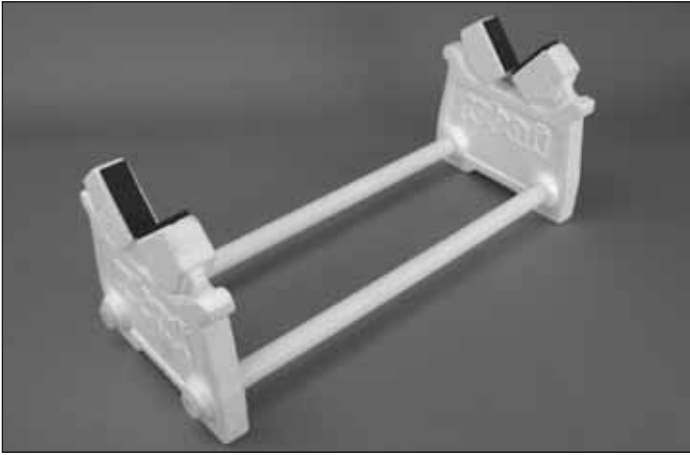

A building stand or cradle comes in handy during the build. We use the Robart Super Stand II (ROBP1402) for all our projects, and it can be seen in pictures throughout this manual.

IMPORTANT BUILDING NOTES

- When you see the term **test fit** in the instructions, it means that you should first position the part on the assembly **without using any glue**, then slightly modify or *custom fit* the part as necessary for the best fit.
- Whenever the term **glue** is written you should rely upon your experience to decide what type of glue to use. When a specific type of adhesive works best for that step, the instructions will make a recommendation.
- Whenever just **epoxy** is specified you may use **either** 30-minute (or 45-minute) epoxy **or** 6-minute epoxy. When 30-minute epoxy is specified it is **highly** recommended that you use only 30-minute (or 45-minute) epoxy, because you will need the working time and/or the additional strength.
- **Photos** and **sketches** are placed **before** the step they refer to. Frequently you can study photos in following steps to get another view of the same parts.
- The stabilizer and wing incidences and engine thrust angles have been factory-built into this model. However, some technically-minded modelers may wish to check these measurements anyway. To view this information visit the web site at www.greatplanes.com and click on "Technical Data." Due to manufacturing tolerances which will have little or no effect on the way your model will fly, please expect slight deviations between your model and the published values.

ORDERING REPLACEMENT PARTS

Replacement parts for the Revolver .46 ARF are available using the order numbers in the Replacement Parts List that follows. The fastest, most economical service can be provided by your hobby dealer or mail-order company.

To locate a hobby dealer, visit the Great Planes web site at www.greatplanes.com. Choose "Where to Buy" at the bottom of the menu on the left side of the page. Follow the instructions provided on the page to locate a U.S., Canadian or International dealer.

Parts may also be ordered directly from Hobby Services by calling (217) 398-0007, or via facsimile at (217) 398-7721, but full retail prices and shipping and handling charges will apply. Illinois and Nevada residents will also be charged sales tax. If ordering via fax, include a Visa® or MasterCard® number and expiration date for payment.

Mail parts orders and payments by personal check to:

Hobby Services
3002 N. Apollo Drive, Suite 1
Champaign, IL 61822

Be certain to specify the order number exactly as listed in the **Replacement Parts List**. Payment by credit card or personal check only; no C.O.D.

If additional assistance is required for any reason, contact Product Support by telephone at (217) 398-8970, or by e-mail at productsupport@greatplanes.com.

Replacement Parts List

Order Number	Description	How to Purchase
	Missing pieces	Contact Product Support
	Instruction manual.....	Contact Product Support
	Full-size plans	Not available

Contact your hobby supplier for the following parts:

GPMA3050	Wing Set
GPMA3051	Fuselage w/Canopy Hatch
GPMA3052	Tail Surface Set
GPMA3053	Landing Gear (L&R)
GPMA3054	Wheelpant Set (L&R)
GPMA3055	Cowl
GPMA3056	Canopy
GPMA3057	Spinner Set
GPMA3058	Decal Sheet
GPMA3059	Wing Joiner Tube

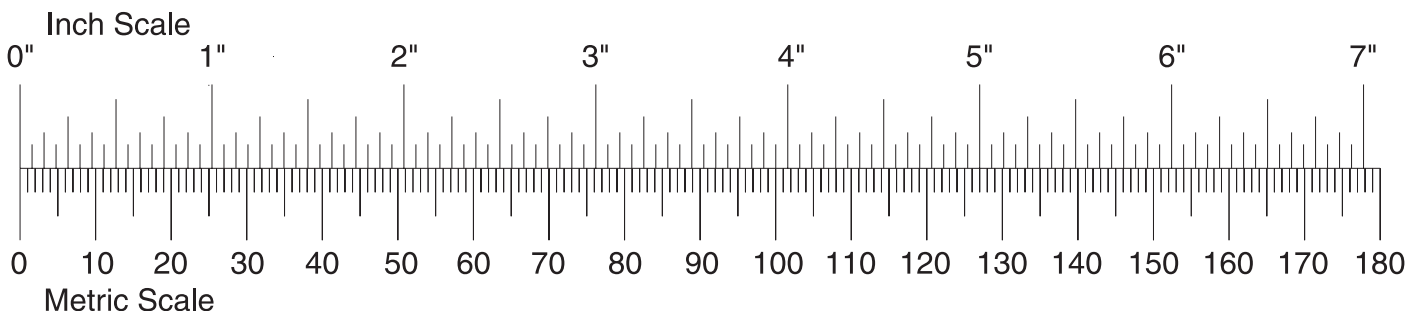

KIT INSPECTION

Before starting to build inspect the parts to make sure they are of acceptable quality. If any parts are missing or are not of acceptable quality, or if you need assistance with assembly, contact **Product Support**. When reporting defective or missing parts, use the part names exactly as they are written in the Kit Contents list.

Great Planes Product Support
3002 N. Apollo Drive, Suite 1
Champaign, IL 61822
Telephone: (217) 398-8970, ext. 5
Fax: (217) 398-7721
E-mail: airsupport@greatplanes.com

KIT CONTENTS

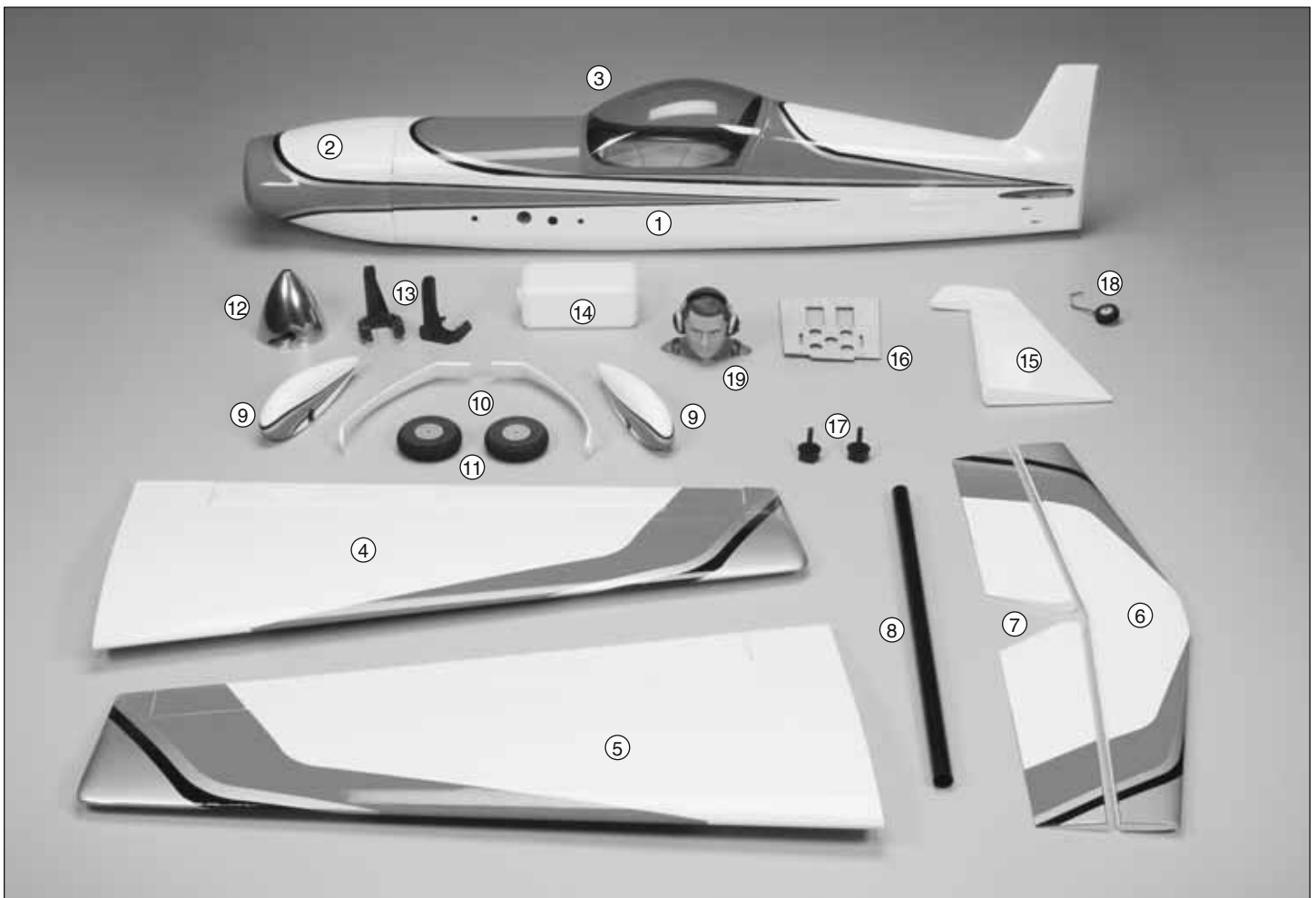

- | | | |
|-------------------------------|------------------------|------------------|
| 1. Fuselage | 8. Aluminum Wing Tube | 15. Rudder |
| 2. Cowl | 9. Wheel Pants (L&R) | 16. Servo Tray |
| 3. Canopy Hatch | 10. Landing Gear (L&R) | 17. Wing Bolts |
| 4. Left Wing Panel w/Aileron | 11. Main Wheels (2) | 18. Tail Wheel |
| 5. Right Wing Panel w/Aileron | 12. Spinner | 19. Pilot Figure |
| 6. Horizontal Stabilizer | 13. Engine Mount | |
| 7. Elevator Halves (L&R) | 14. Fuel Tank | |

PREPARATIONS

- ❑ 1. If you have not done so already, remove the major parts of the kit from the box and inspect for damage. If any parts are damaged or missing, contact Product Support at the address or telephone number listed in the "Kit Inspection" on the previous page.



- ❑ 2. Carefully remove the tape and separate all the control surfaces. Use a covering iron with a covering sock on high heat to tighten the covering if necessary. Apply pressure over sheeted areas to **thoroughly** bond the covering to the wood.

BUILD THE WING

Install the Ailerons

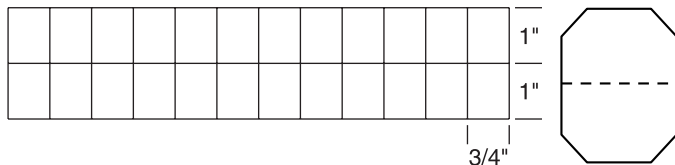

- ❑ 1. Cut the included 2" x 9" [51mm x 229mm] CA hinge strip into 3/4" x 1" [19mm x 25mm] individual hinges. Clip the corners of each hinge to make them easier to insert into the hinge slots.

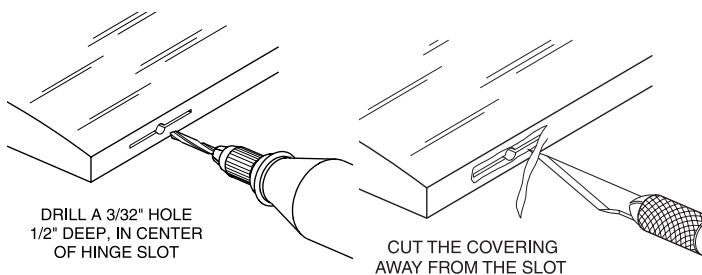

- ❑ 2. Drill a 3/32" [2.4mm] hole 1/2" [13mm] deep into the center of each hinge slot in the **aileron** and **wing panel**. Trim the covering away from each hinge slot to ensure that the hinges will be properly glued in place.

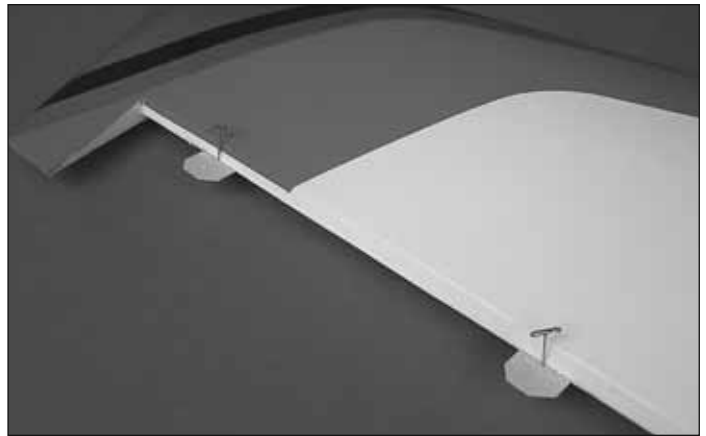

- ❑ 3. Test fit a CA hinge into each of the hinge slots in the wing panel and aileron. If necessary, enlarge the slots with a hobby knife. When satisfied with the fit, insert a CA hinge halfway into each hinge slot in the wing panel. Push a pin through the middle of each hinge to keep them centered.



- ❑ 4. Join the aileron to the wing panel and remove the pins from the hinges. Center the aileron on the wing.

- ❑ 5. Adjust the aileron so there is a small gap between the LE of the aileron and the wing. The gap should be small, just enough to see light through the gap or to slip a piece of paper through.

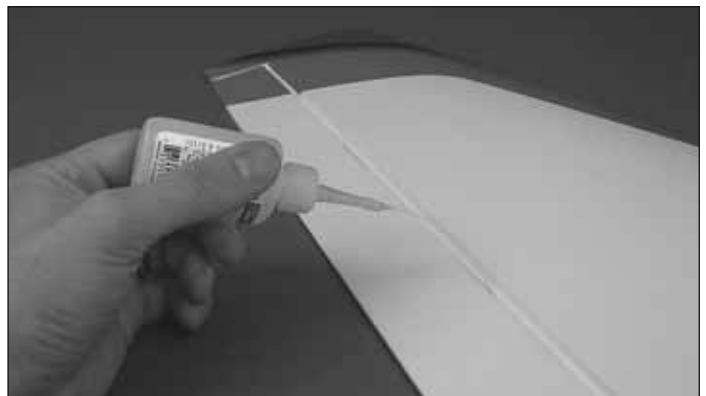

- ❑ 6. Apply six drops of thin CA to the top and bottom of each hinge without using accelerator. After the CA glue has hardened, confirm that the aileron is secure by pulling on it and deflecting it up and down.

- ❑ 7. Repeat steps 2-6 for the other wing panel.

Install the Aileron Servos & Pushrods

Before completing this section, confirm that the servos that you will be using will properly fit between the servo mounting block locations on the aileron servo hatch covers. Make adjustments as necessary for your brand servos. The block locations shown in this section will fit a standard size Futaba brand servo.

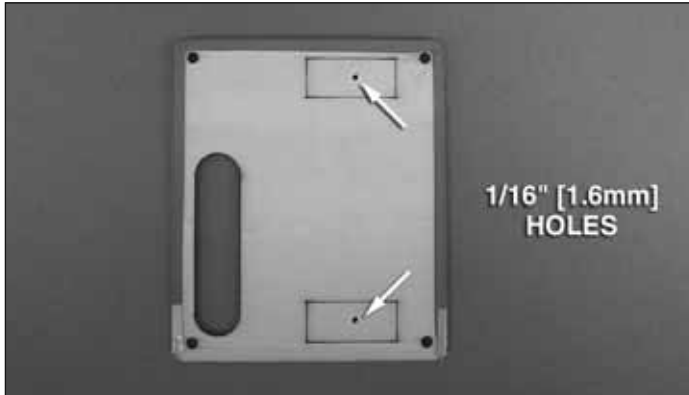

1. Drill a 1/16" [1.6mm] hole through the **aileron servo hatch covers** in the center of each etched rectangle on the inside of the covers.

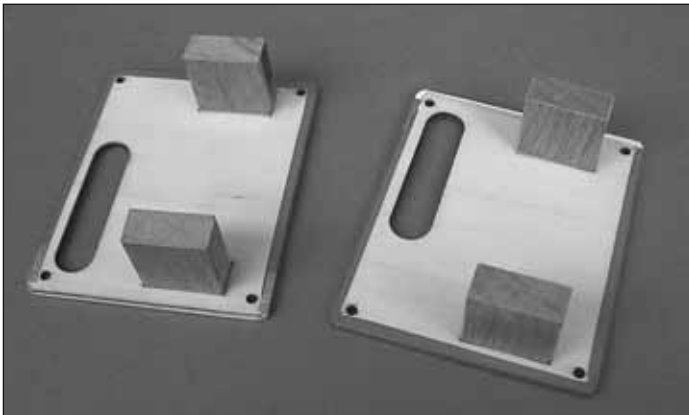

2. Use epoxy to glue the 11/16" x 11/16" x 5/16" [18mm x 18mm x 8mm] hardwood servo mounting blocks to the insides of the hatch covers. Be sure that the blocks are aligned over the rectangles with the grain direction perpendicular to the covers as shown. Allow the epoxy to cure undisturbed.



3. With the epoxy completely cured from step 2, continue the 1/16" [1.6mm] holes in the hatch covers through the mounting

blocks approximately 3/8" [9.5mm] deep. Thread a #2 x 3/8" [9.5mm] flat head wood screw into each hole and back it out. Apply a drop of thin CA glue to each hole to harden the wood. When the CA glue has dried, thread a #2 x 3/8" [9.5mm] flat head screw into each of the four holes.

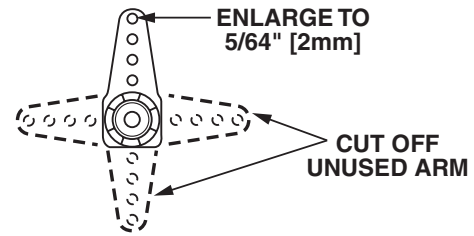

4. Cut three arms from a four-armed servo arm for each aileron servo. Enlarge the outer hole of each remaining arm with a 5/64" [2mm] drill bit.

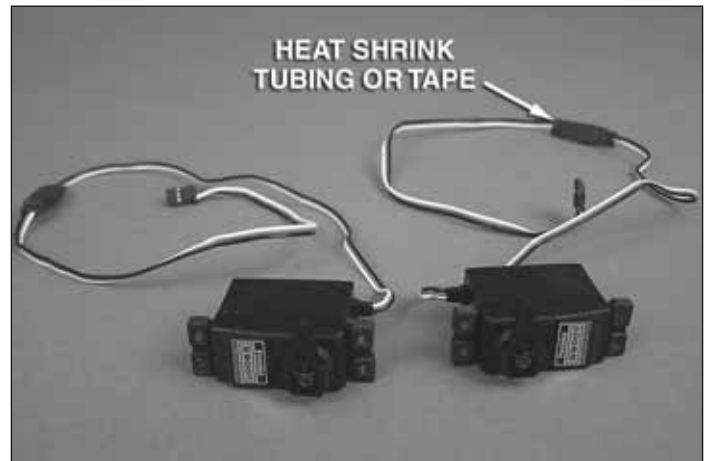

5. Attach a 6" [152mm] servo extension to each aileron servo and secure the connector using tape or heat shrink tubing (not included). Center the servos with your radio system and install the servo arms to the servos perpendicular to the servo cases as shown. Be sure to reinstall the servo arm screws into the servos.



6. Position the servos against the underside of the aileron servo hatch covers between the mounting blocks. Drill 1/16" [1.6mm] holes through the mounting tabs on the servo cases into the blocks. Thread a servo mounting screw (included

with the servo) into each hole and back it out. Apply a drop of thin CA to each hole to harden the wood. When the CA has dried, install the servos onto the hatch covers using the hardware supplied with the servos.

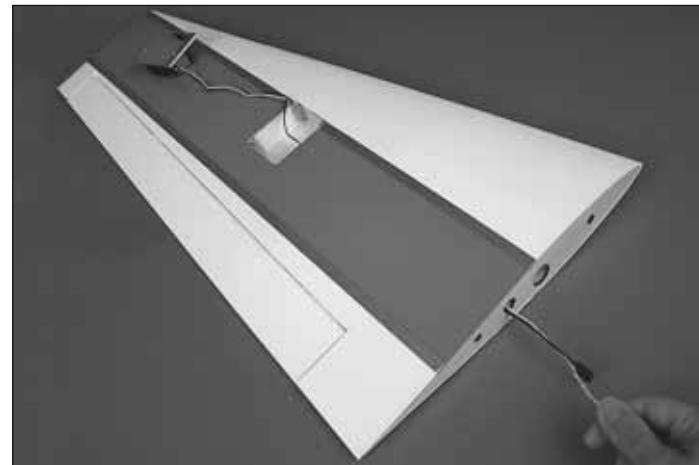
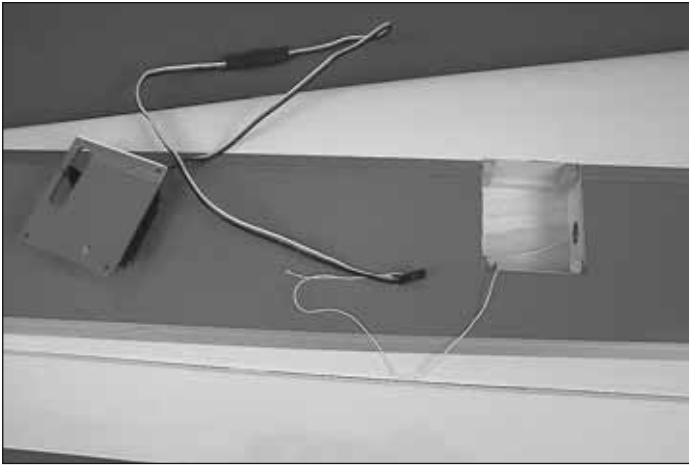

□ 7. Use the strings taped inside the aileron servo hatches to pull the servo leads through the wing ribs.

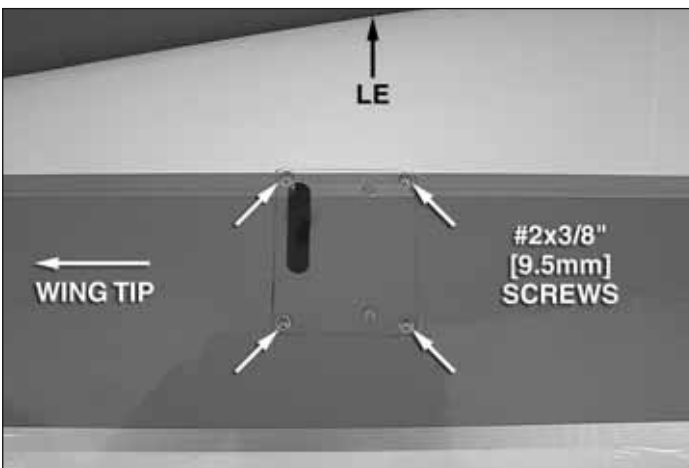

□ 8. Position the aileron servo hatch covers in place and drill a 1/16" [1.6mm] hole through the mounting holes and into the hatch mounting blocks. Thread a #2 x 3/8" [9.5mm] self-tapping screw into each hole and back it out. Apply a drop of thin CA to each hole to harden the wood. Install the hatch covers to the wings using eight #2 x 3/8" [9.5mm] self-tapping screws and eight #2 flat washers.

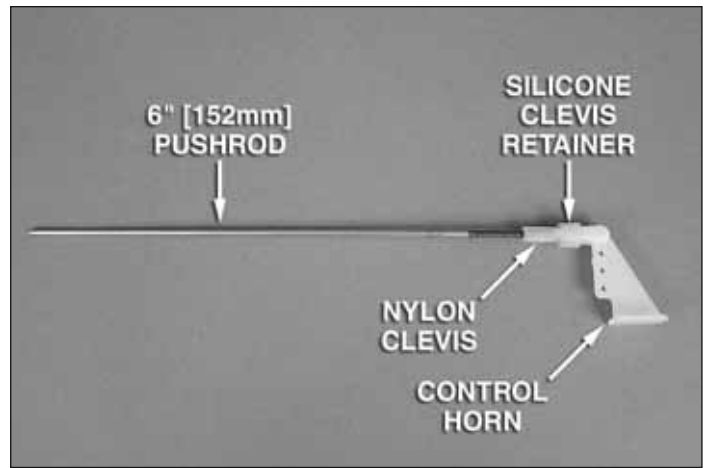

□ 9. Thread a nylon clevis 20 complete turns onto each 6" [152mm] pushrod. Slide a silicone clevis retainer onto each clevis and connect the clevises to the outer holes of two control horns.

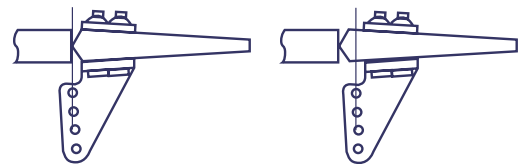
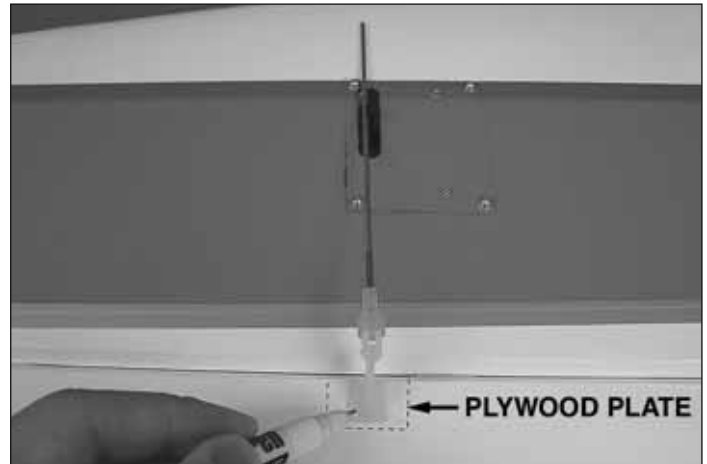

Correct

Incorrect

□ 10. Position the control horns over the plywood plates in the ailerons (if you cannot see them, hold the aileron at a shallow angle in good lighting or use a small pin to puncture the covering) using the position of the servo arms as a guide. Align the holes in the control horns directly over the aileron hinge line and mark the location of the control horn mounting holes.

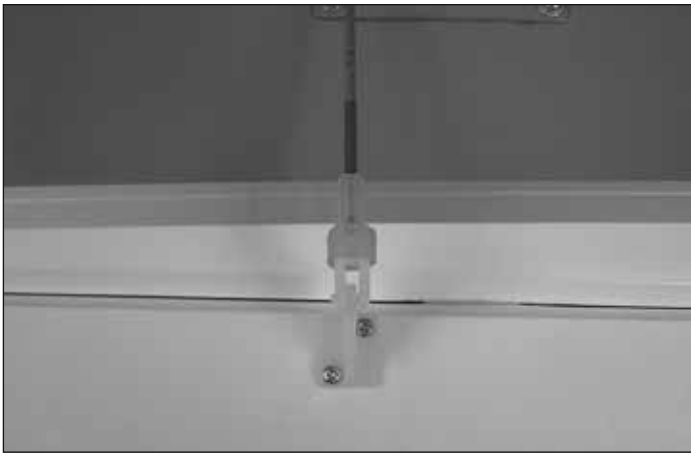

cross the outer holes in the servo arms. Make a 90 degree bend at the mark on the pushrod and cut off the excess pushrod 1/4" [6mm] beyond the bend. Attach the pushrods to the servo arms using nylon FasLinks. Thread the clevises up or down on the pushrods as necessary to center the ailerons with the servo arms centered. When satisfied, slide the silicone clevis retainers to the ends of the clevises to secure them.

❑ 11. Drill 1/16" [1.6mm] holes at the marks you made through the plywood plates. **Do not drill all the way through the ailerons!** Thread a #2 x 3/8" [9.5mm] self-tapping screw through each hole and back it out. Apply a couple drops of thin CA glue to each hole to harden the wood. When the glue has dried, install the control horns onto the ailerons using four #2 x 3/8" [9.5mm] self-tapping screws.

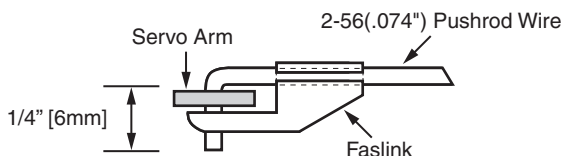
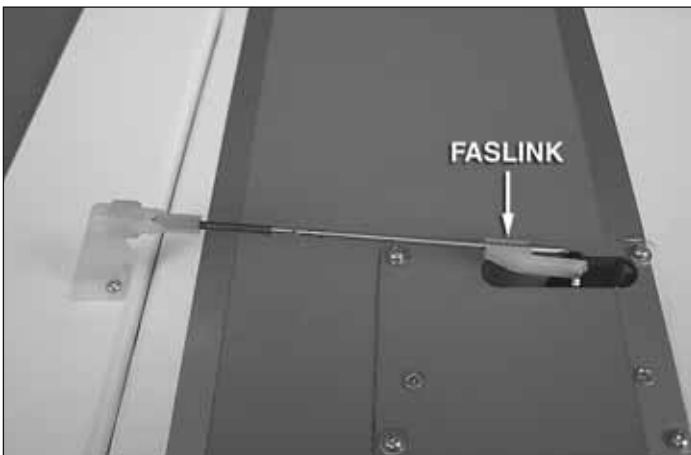
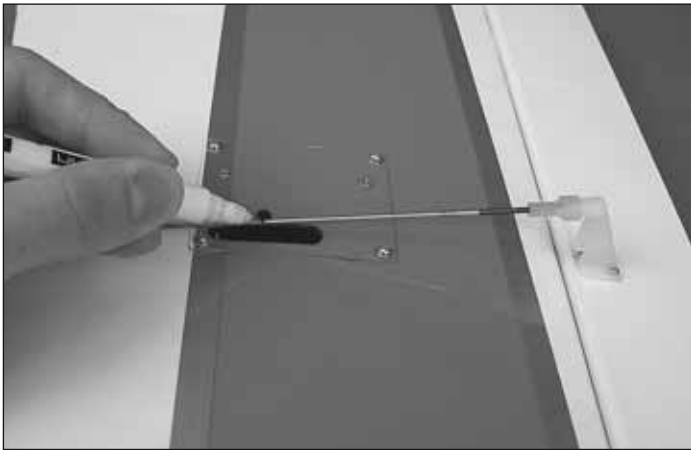

❑ 12. Use tape or a small clamp to hold the ailerons in the neutral position. Make a mark on the pushrods where they

Finish the Wing Panels

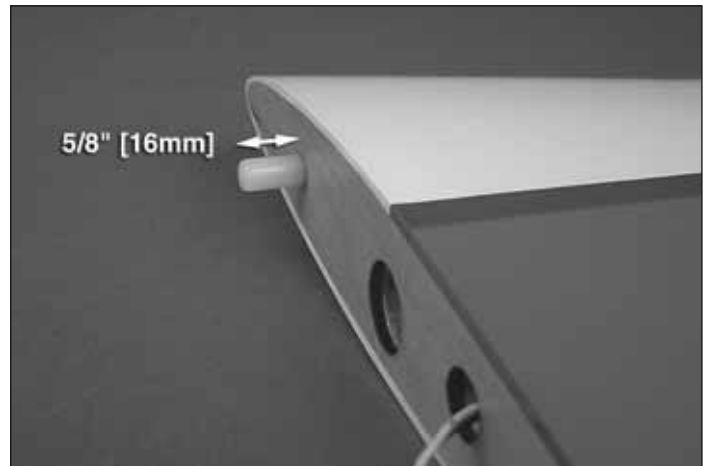

❑ 1. Use epoxy to glue the **anti-rotation pins** into the holes in the root ribs of the wing panels near the leading edge. The pins should protrude from the root ribs approximately 5/8" [16mm]. Use a paper towel dampened with denatured alcohol to wipe away any excess epoxy.

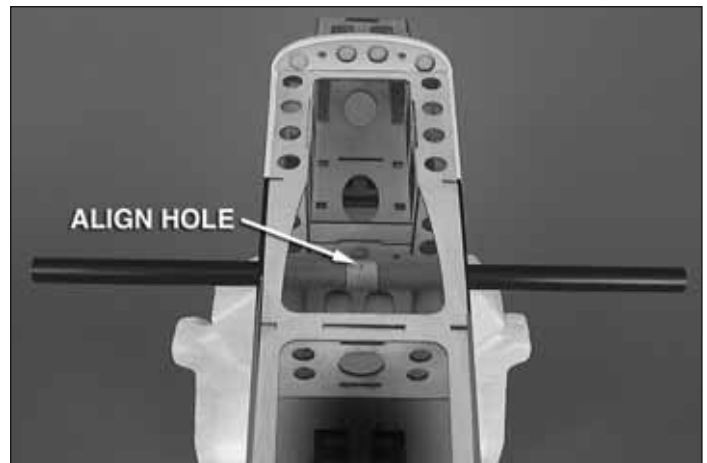

❑ 2. Slide the **aluminum wing tube** into the **fuselage** aligning the hole in the center of the wing tube with the hole in the fiberglass tube in the fuselage.

BUILD THE FUSELAGE

Assemble the Tail Section

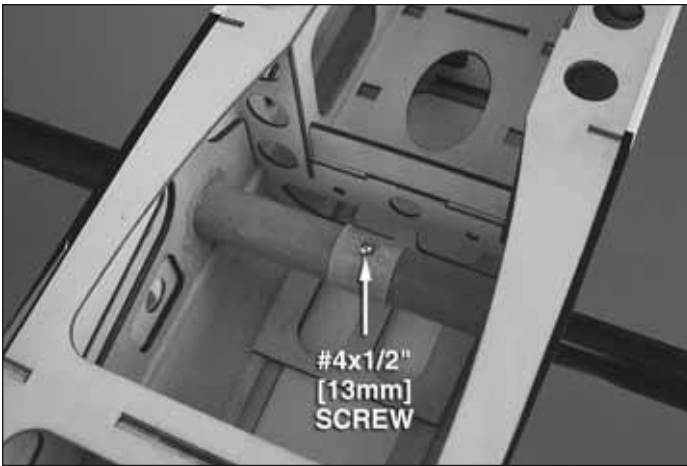

❑ 3. Secure the wing tube to the fuselage using a #4 x 1/2" [13mm] self-tapping screw.

❑ 4. Test fit the **nylon wing bolts** into the blind nuts in the wing panels. If the bolts are difficult to thread into the blind nuts, insert a 1/4-20 tap into the nuts to clean up the threads.

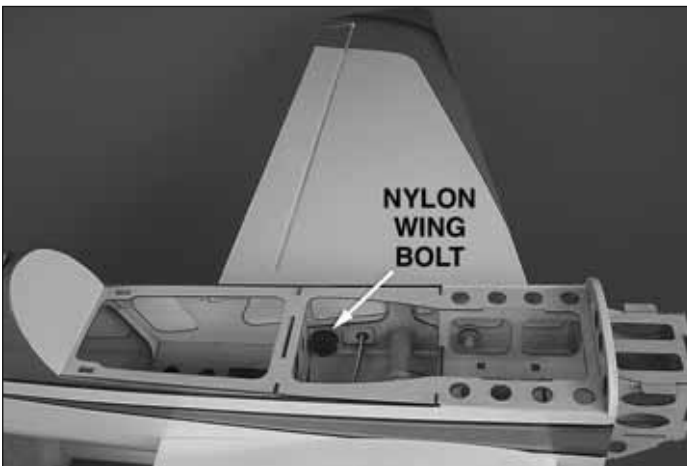

❑ 5. Install the wing panels onto the wing tube and secure them to the fuselage using two nylon wing bolts.



❑ 1. Slide the **horizontal stabilizer** into the stab slot at the aft end of the fuselage. Center the stab left and right in the fuselage. Measure the distance from the stab tips to the wing tips and make the measurements equal. When satisfied, use a felt-tip pen to trace around the stab where it meets the fuse.

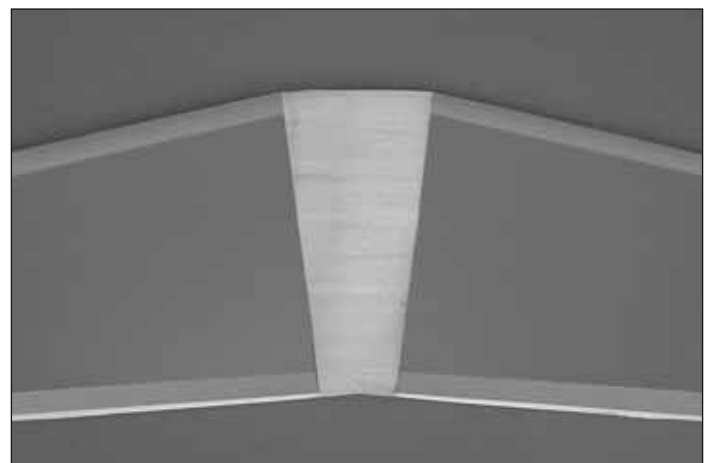

❑ 2. Trim the covering from the stab 1/16" [1.6mm] inside the lines you drew.



HOW TO CUT COVERING FROM BALSA

Use a soldering iron to cut the covering from the stab. The tip of the soldering iron doesn't have to be sharp, but a fine tip does work best. Allow the iron to heat fully.

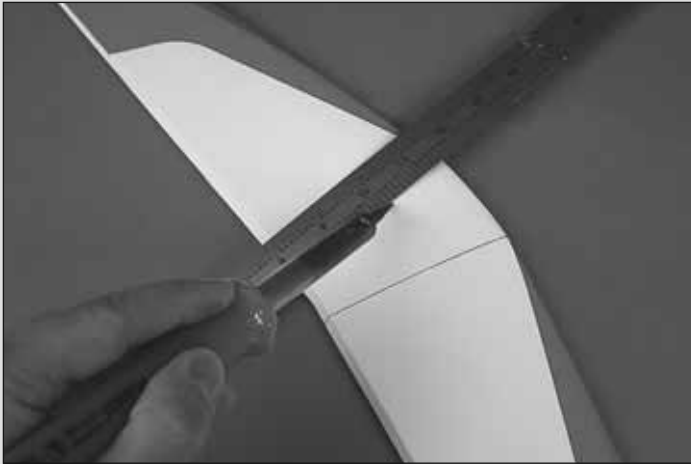

Use a straightedge to guide the soldering iron at a rate that will just melt the covering and not burn into the wood. The hotter the soldering iron, the faster it must travel to melt a fine cut. Peel off the covering.

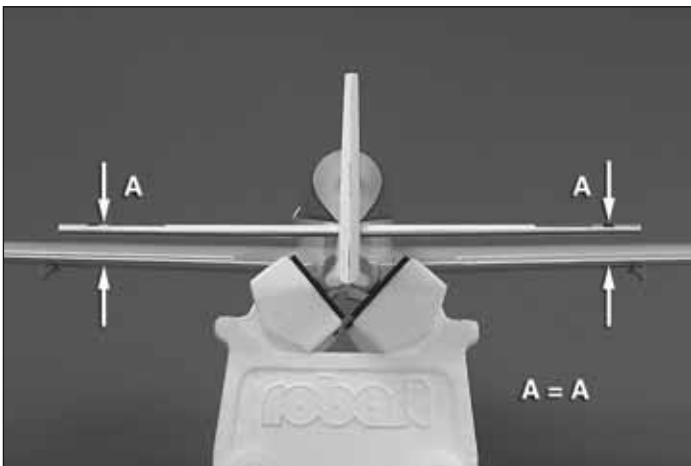

❑ 3. Use 30-minute epoxy to glue the stab into the fuselage. View the model from behind and confirm that the stab is parallel with the wing panels. If not, use a weight on one side of the stab or tape to bring the stab parallel. Lightly sanding the stab slot may also be necessary. Use denatured alcohol to clean up any excess epoxy. Allow the epoxy to cure undisturbed.

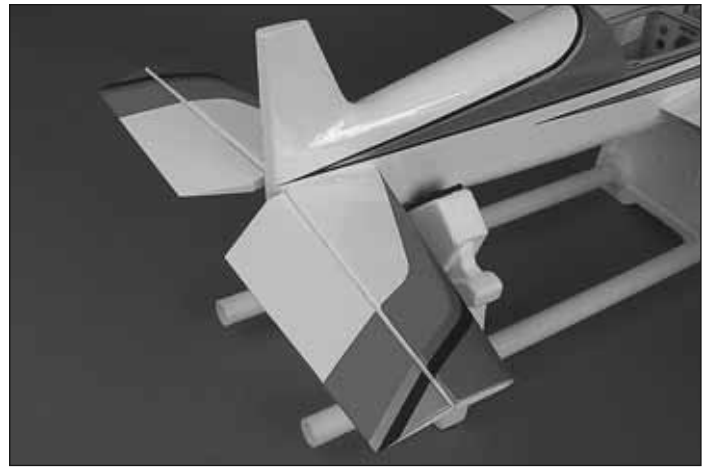

❑ 4. As you did with the ailerons, attach the **elevator halves** to the horizontal stabilizer using CA hinges.

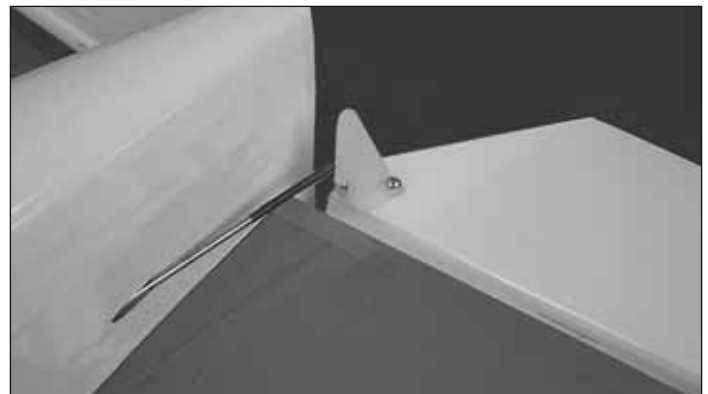
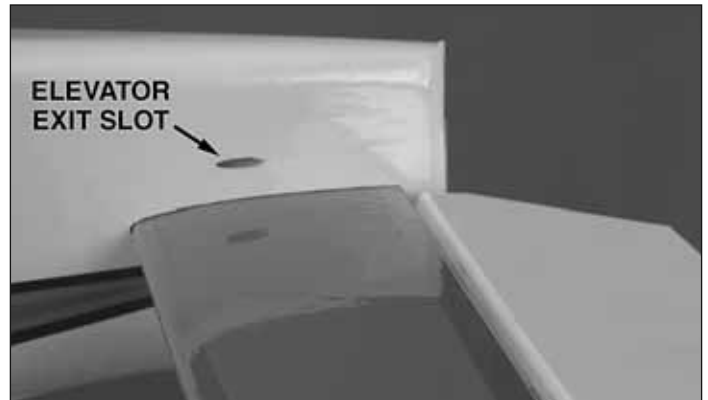
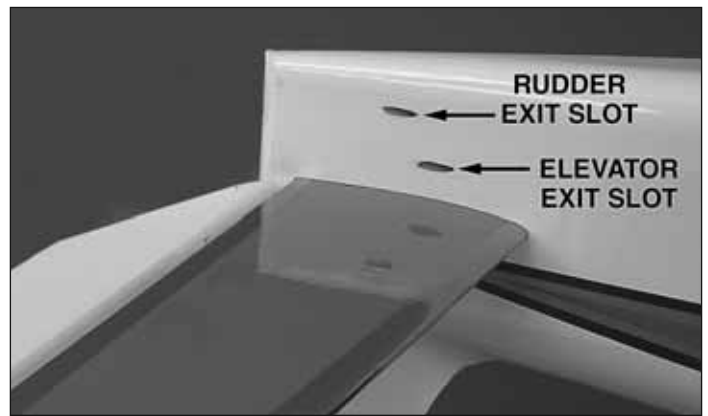

❑ 5. Temporarily insert a 2-56 x 36" [914mm] pushrod into each elevator pushrod exit slot. Use the position of the pushrod to align the elevator control horns onto the undersides of the

elevator halves. Mark the locations of the control horn mounting holes onto the elevator halves and drill 1/16" [1.6mm] holes at the marks. Do not drill all the way through the elevator halves! Thread a #2 x 3/8" [9.5mm] self-tapping screw into each hole and back it out. Apply a couple drops of thin CA glue to each hole and let it harden. Attach the elevator control horns to the elevators using four #2 x 3/8" [9.5mm] self-tapping screws.

- ❑ 6. Secure the tail wheel to the **tail wheel assembly** with a 3/32" [2.4mm] wheel collar and a 4-40 set screw. Be sure that the tail wheel rotates freely on the axle. Oil the axle if necessary.

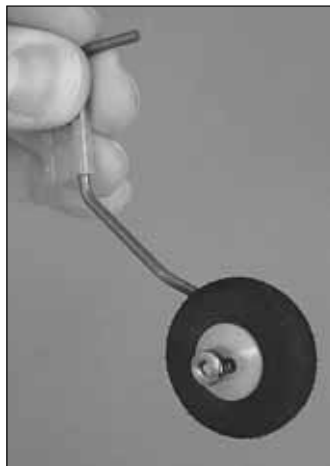

alcohol. Glue the tail wheel wire into the hole in the LE of the rudder with medium or thick CA glue. Be sure not to get glue onto the nylon tab where it rotates on the wire (oil applied on the tail wheel wire around the tab will help prevent glue from sticking to it). Lightly coat both sides of the nylon tab with thick CA glue or epoxy and fit the rudder to the fuselage along with two CA hinges. Glue the CA hinges in place with thin CA glue.



- ❑ 9. As you did with the elevator halves, use a 2-56 x 36" [914mm] pushrod to position a control horn onto the left side of the rudder. Attach it using two #2 x 3/8" [9.5mm] self-tapping screws.

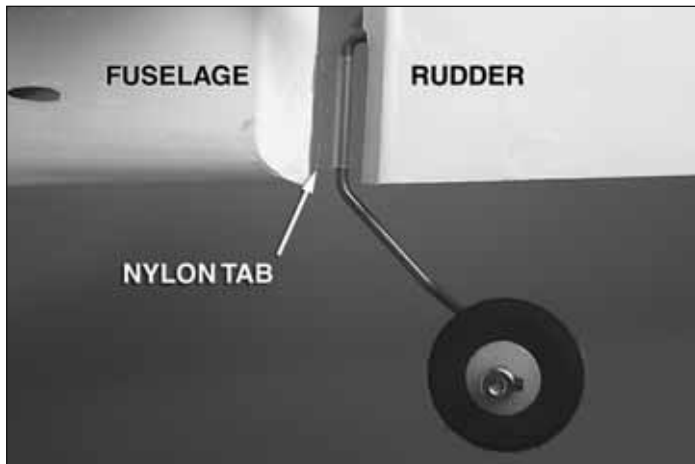

- ❑ 7. Test fit the rudder to the fuselage with the tail wheel assembly installed in the orientation shown. Make any adjustments necessary so the nylon tab on the tail wheel wire fits all the way into the slot in the fuse.



- ❑ 8. Roughen the portion of the tail wheel assembly that fits into the rudder with 220-grit sand paper and clean it off with

Install the Tail Servos & Pushrods

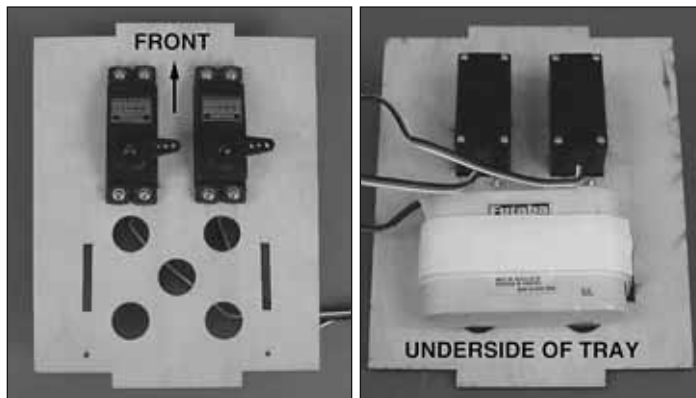

- ❑ 1. Install the elevator and rudder servos into the servo tray in the direction shown using the hardware supplied with the servos. Be sure to harden the screw holes with thin CA as was done with the aileron servos. Cut three arms from two four-armed servo arms. Center the servos with your radio system and install them onto the servos with the servo screws. Enlarge the outer holes of each servo arm with a 5/64" [2mm] drill bit. If you plan to install a brushless motor, an aft receiver battery location is provided on the servo tray for balancing purposes. Use the included hook and loop material with a piece of 1/4" [6mm] or 1/2" [13mm] foam rubber (not included) to strap the receiver pack to the underside of the servo tray so it will not interfere with the elevator and rudder pushrods. If you are installing a glow engine, the receiver battery is installed at the front of the fuselage later on in the build process.

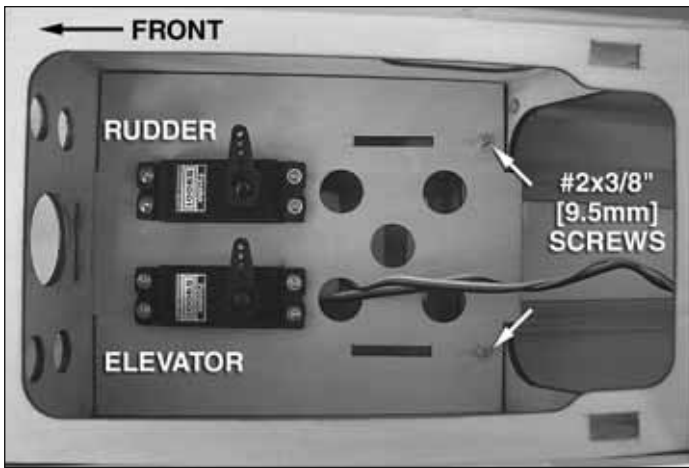

❑ 2. Fit the servo tray into the fuselage. The tab at the front of the tray slides into the slot in the former behind the wing tube. Drill a 1/16" [1.6mm] hole through the two mounting holes in the tray. Thread a #2 x 3/8" [9.5mm] self-tapping screw into each hole and back it out. Apply a couple drops of thin CA to each hole to harden the wood. When the glue has dried, secure the tray inside the fuselage using two #2 x 3/8" [9.5mm] self-tapping screws and two #2 flat washers.



❑ 3. Thread a nylon clevis and silicone clevis retainer onto a 2-56 x 36" [914mm] pushrod 20 complete turns. Slide the pushrod through the rudder pushrod exit slot in the fuselage and connect it to the second from outer hole in the rudder control horn.

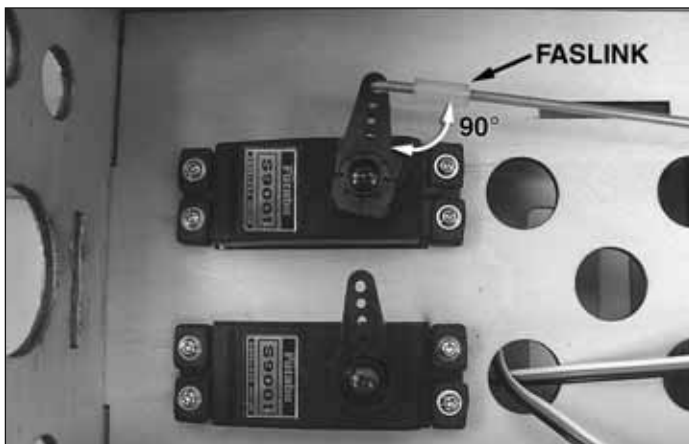

❑ 4. With the rudder in the neutral position and the rudder servo arm perpendicular to the pushrod, mark where the

pushrod crosses the outer hole of the servo arm. As you did with the aileron pushrods, make a 90 degree bend at the mark and cut off the excess pushrod 1/4" [6mm] beyond the bend. Secure the pushrod to the servo arm with a nylon FasLink. Make any adjustments necessary to the nylon clevis so that the rudder is properly centered and slide the silicone clevis retainer to the end of the clevis.



❑ 5. Attach two 2-56 x 36" [914mm] pushrods with nylon clevises and silicone clevis retainers to the third from outer holes in the elevator control horns.

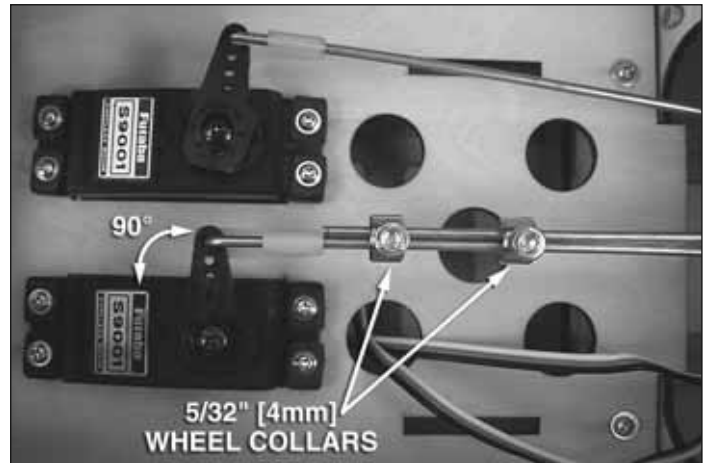

❑ 6. With the left elevator in the neutral position and the elevator servo perpendicular to the servo case, mark the location where the left elevator pushrod crosses the outer hole of the elevator servo arm. Make a 90 degree bend at the mark and cut off the excess pushrod 1/4" [6mm] beyond the bend. Position the right elevator in the neutral position and cut off the excess pushrod 1" [25mm] behind the elevator servo arm. Join the two elevator pushrods together using two 5/32" [4mm] wheel collars, two 6-32 x 1/4" [6mm] SHCS and thread locking compound. View the model from behind and confirm that the elevator halves are parallel. If not, make any adjustments as necessary to the clevises or wheel collars until they are.

Assemble and Install the Main Landing Gear

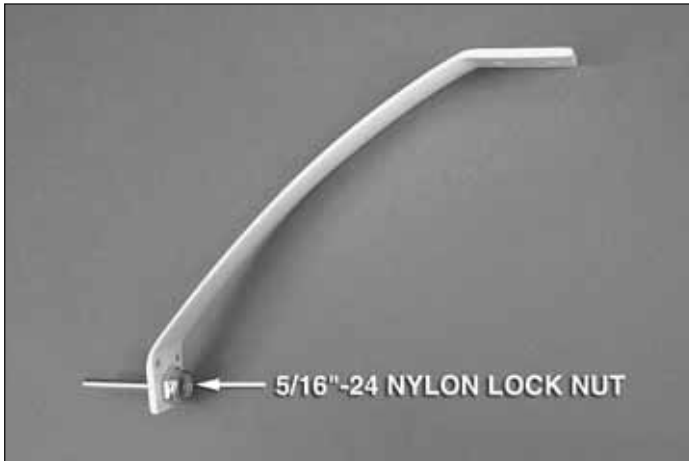

- ❑ 1. Secure the axles to the landing gear legs using the 5/16"-24 nylon lock nuts.

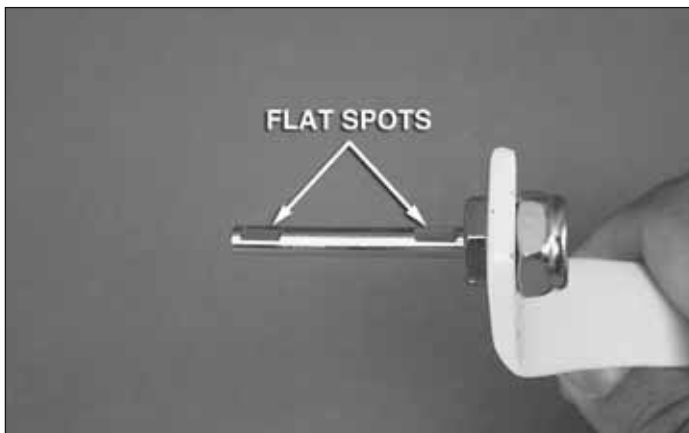
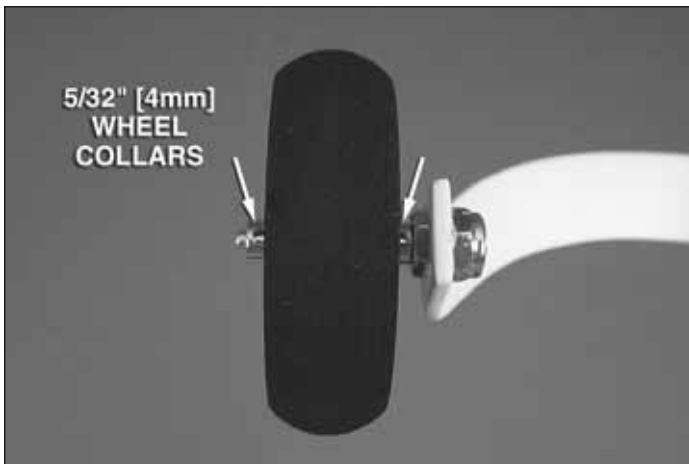

- ❑ 2. Slide a 5/32" [4mm] wheel collar onto each axle followed by a 2-3/4" [70mm] wheel and then another 5/32" [4mm] wheel collar. Mark the location of the threaded holes in the wheel collars onto the axles. Use a file or rotary tool such as a Dremel to grind flat spots at the marks on the axles.

- ❑ 3. Reinstall the wheel collars and wheels onto the axles. Thread a 6-32 set screw into each wheel collar and tighten the set screws against the flat spots on the axles. Be sure that the wheel rotates freely on the axle. Oil the axles if necessary.



- ❑ 4. Attach the wheel pants to the landing gear legs using four 2-56 x 3/8" [9.5mm] machine screws, four #2 flat washers, four #2 lock washers, and thread locking compound.

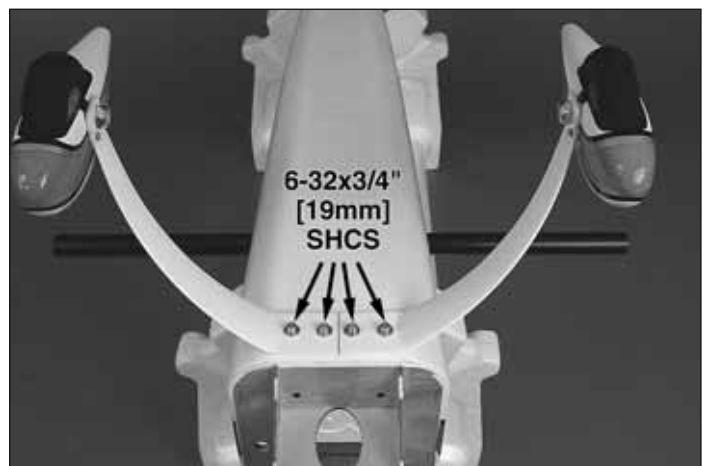

- ❑ 5. Attach the landing gear legs to the fuselage using four 6-32 x 3/4" [19mm] SHCS, four #6 flat washers, four #6 lock washers, and thread locking compound.

INSTALL THE POWER SYSTEM

Glow Engine Installation

The Revolver ARF is designed to be flown with a .46-.55 two-stroke glow engine, .70 four-stroke glow engine, or an out-runner brushless motor. If you plan to install a brushless motor, skip ahead to page 19, "Brushless Motor Installation".

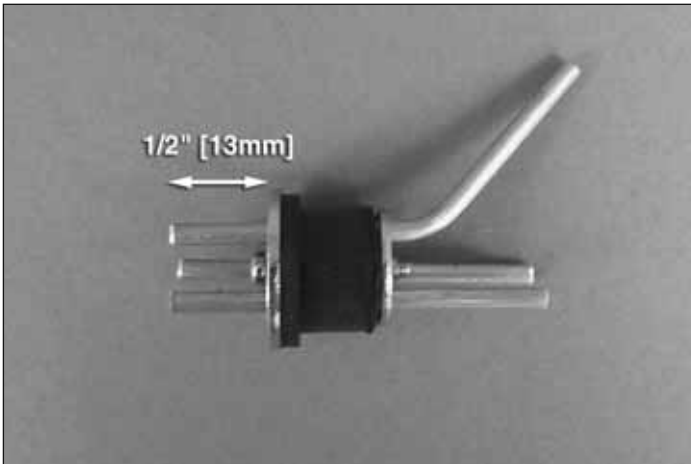
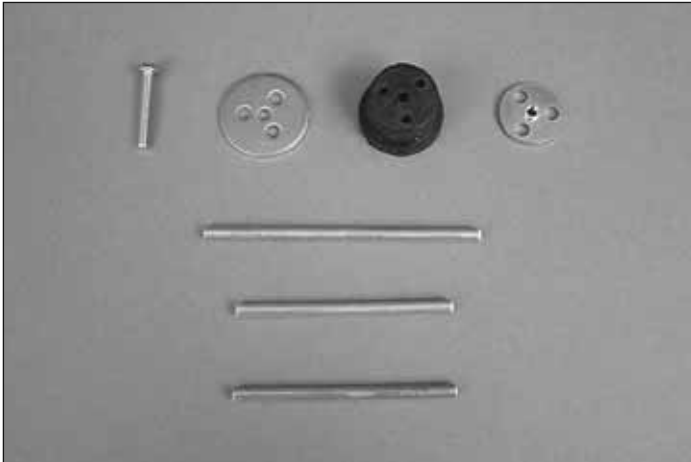

❑ 1. The fuel tank can be assembled as a two line system consisting of a vent (pressure) line to the muffler and a carb line. Filling and emptying of the tank would need to be done through the carb line, or an optional fuel fill valve (not included). The tank can also be assembled as a three line system having a vent line, carb line, and fill line. If installing a fill line, puncture the top of the stopper above the sealed off fuel tube hole. The fill and carb lines should extend out 1/2" [13mm] beyond the stopper and the vent line should be bent upwards and left uncut. With the tubes installed in the stopper, fit the stopper plates loosely in place with the 3x25mm phillips screw to hold the assembly together.

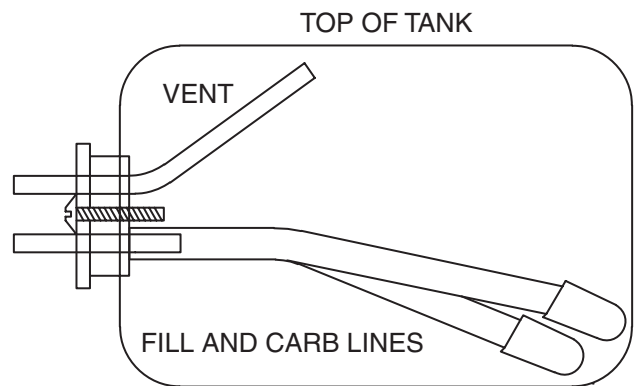

❑ 2. Fit the stopper assembly into the tank with the vent line pointing toward the top of the tank, but not touching. The fuel tubing and clunks (fuel pickup) on the carb and fill lines should almost reach the back of the tank but not touch. The clunks must be able to move freely inside the tank when assembled. Adjust the length of the fuel tubing accordingly. When satisfied, tighten the 3x25mm screw in the stopper to secure it in place (do not over-tighten). Mark the side of the tank that must face up when installed in the plane. We also suggest marking the tubes in the stopper.

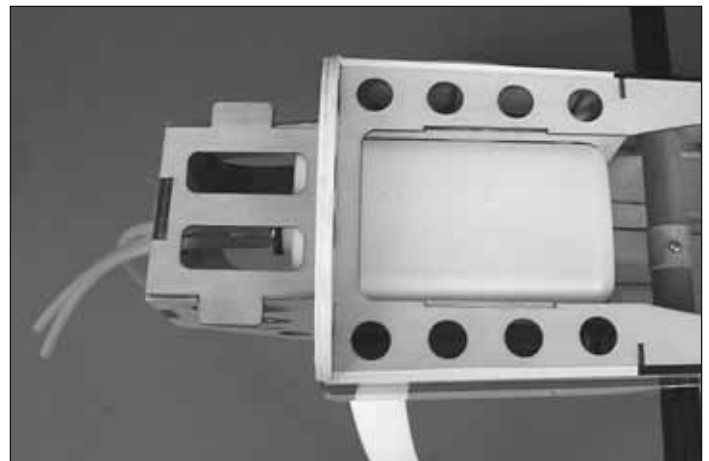

❑ 3. Attach a 6"-7" [152mm-178mm] piece of fuel tubing onto each line coming from the tank. Insert the tank into the fuselage with the correct side facing up. The fuel tubing should be routed through the hole in the center of the firewall.

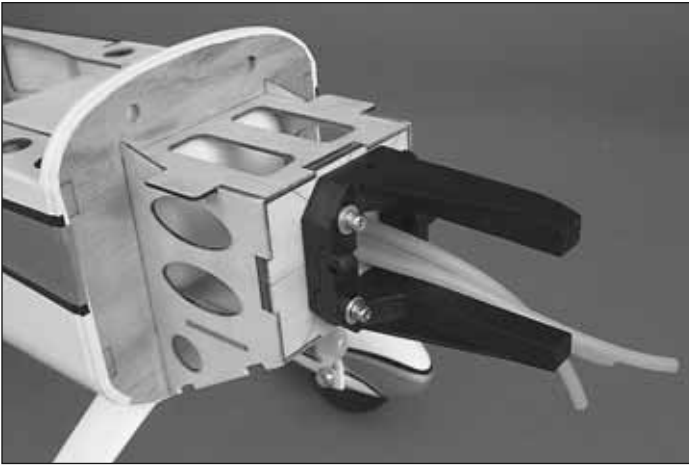

□ 4. Using four 6-32 x 1" [25mm] SHCS, four #6 flat washers, four #6 lock washers, and thread locking compound, attach the engine mount side-mounted to the firewall so that the engine head will be on the right side. Leave the screws slightly loose. Test fit your engine between the mount halves. Slide the mount halves against the sides of the engine and finish tightening the mount screws.

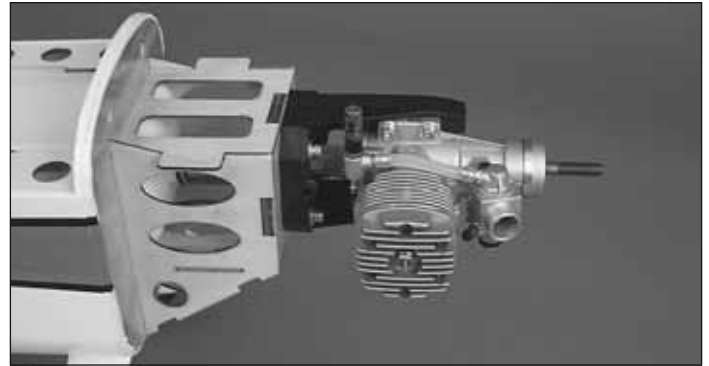

□ 5. Position the front of the engine drive washer 4-5/8" [117mm] from the front of the engine mounting box. Mark the location of the engine mount holes onto the mount rails using a Dead Center Hole Locator (GPMR8130). Remove the engine from the mount and use a 6-32 tap and drill set to create threads in the four mounting holes. Attach the engine to the mount using four 6-32 x 3/4" [19mm] SHCS, four #6 flat washers, and four #6 lock washers.

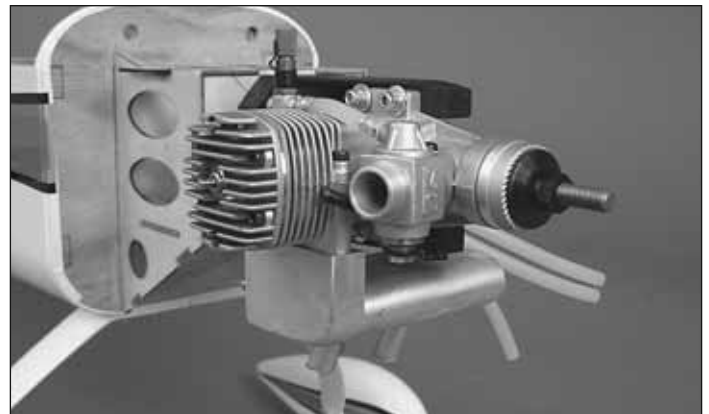

□ 6. If you installed a two-stroke engine, attach a Pitts-style in-cowl muffler. The stock muffler could also be used, but excessive cutting of the cowl would be necessary. We suggest using a Pitts-style muffler as shown in the picture.

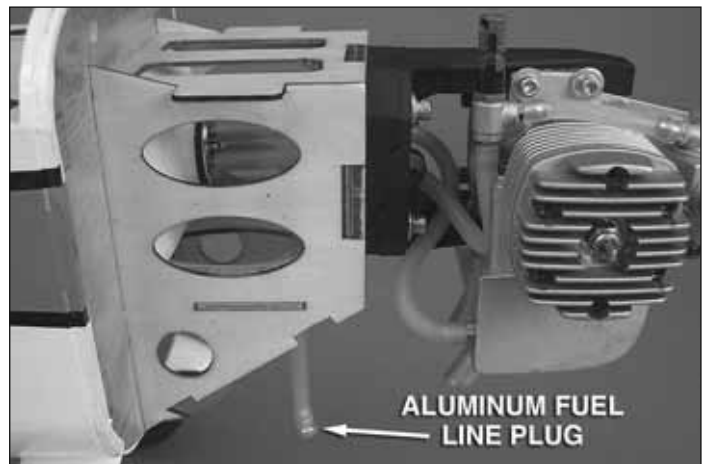
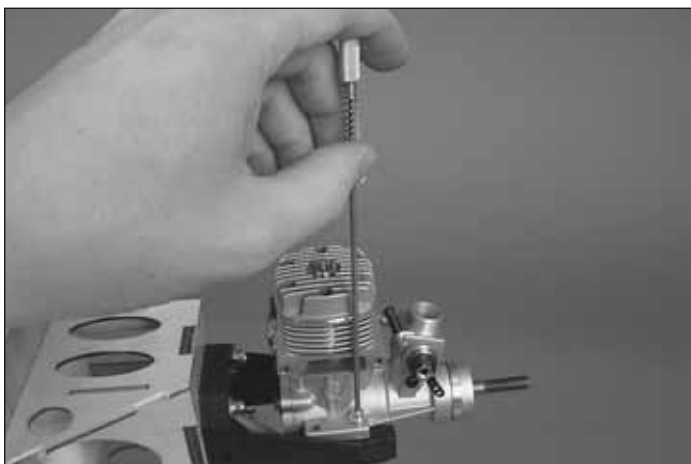
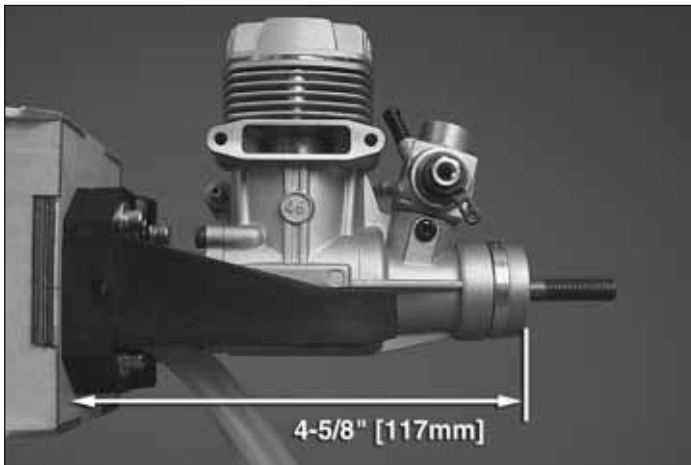

□ 7. Cut the fuel tubing coming from the tank to the proper length and connect the pressure and carb lines to the engine. The fill line (if installed) should be plugged with the included aluminum fuel line plug and able to hang free from the bottom of the plane. Be sure to replace the fuel line plug after filling or draining the fuel tank.

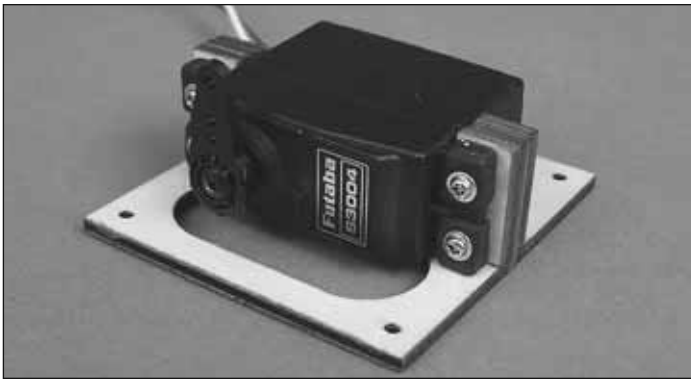

❑ 8. Cut three arms from a four-armed servo arm included with your throttle servo. Enlarge the outer hole of the servo arm using a 5/64" [2mm] drill bit. Center the servo with your radio system and install the arm perpendicular to the servo case. Install the throttle servo onto the throttle servo tray using the hardware supplied with the servo. Most engine models will require the throttle servo to be oriented on the tray in the direction shown.

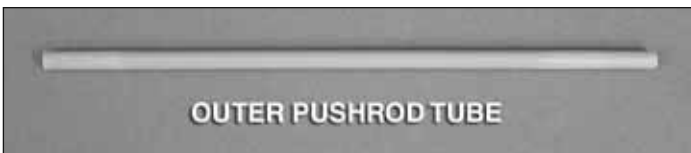

❑ 9. Roughen the ends of the 6" [152mm] outer pushrod tube using 220-grit sandpaper. Slide the outer pushrod tube through the hole in the firewall that is closest to the engine carburetor. The tube should also pass through one of the pushrod tube holes in the second former. Glue the outer pushrod tube to the firewall and second former.



❑ 10. Place the throttle servo tray into the fuselage, aligning the servo arm with the outer pushrod tube. Drill through the four mounting holes on the tray using a 1/16" [1.6mm] bit. Thread a #2 x 3/8" [9.5mm] self-tapping screw into each hole and back it out. Apply a couple drops of thin CA glue to each hole to harden the wood. When the CA has dried, screw the tray to the fuse using four #2 x 3/8" [9mm] self-tapping screws and four #2 flat washers.

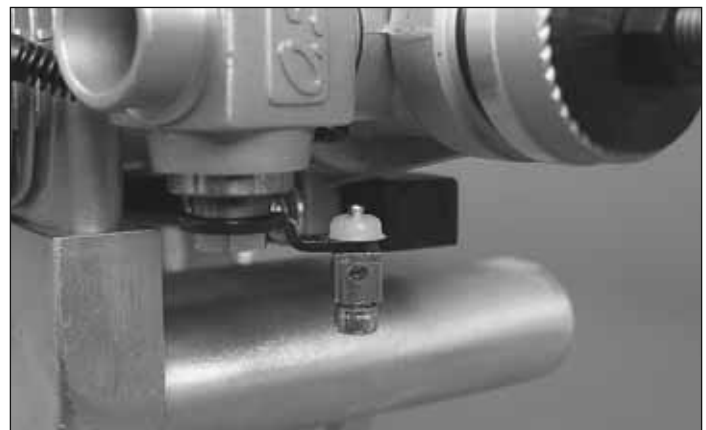

❑ 11. Install a brass screw-lock connector onto the outer hole of the throttle arm on the carburetor using a nylon retainer. Thread a 4-40 x 1/8" [3mm] SHCS loosely into the screw-lock connector.

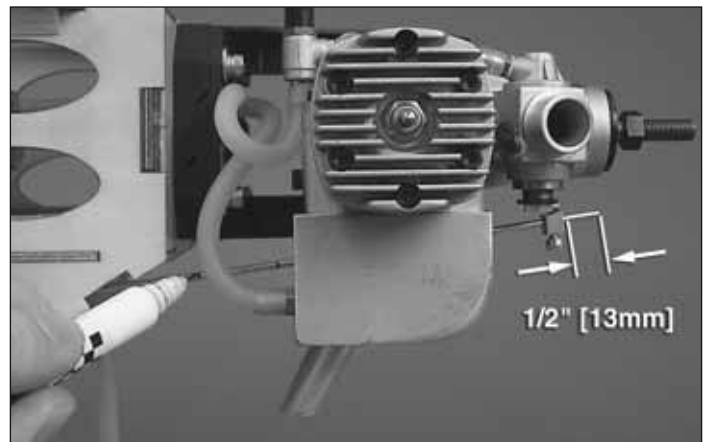

❑ 12. To make the remaining 2-56 x 36" [914mm] pushrod easier to work with, cut it down to approximately 18" [457mm]. The threaded end will not be used so it can be cut off. Slide the pushrod through the outer pushrod tube installed in the

firewall with the forward end slid over the muffler and into the screw-lock connector on the throttle arm. The forward end of the pushrod should protrude beyond the screw-lock pushrod connector approximately 1/2" [13mm]. Mark on the pushrod where it will need to be bent in order to clear the muffler and move back and forth smoothly.

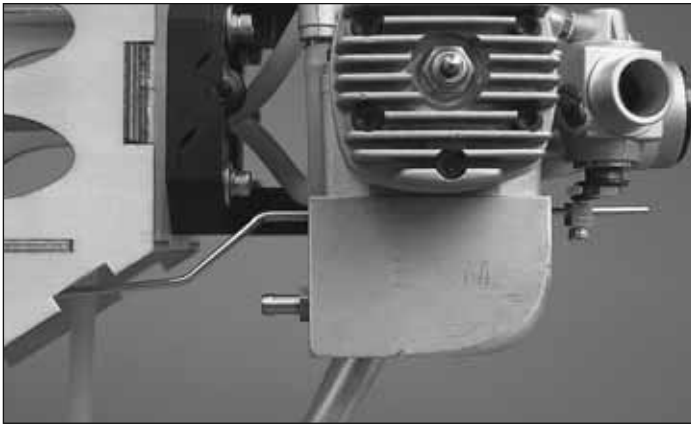

❑ 13. Remove the pushrod and make the necessary bends. Reinstall the pushrod into the outer pushrod tube and screw-lock connector and test its operation by hand. Make any adjustments to the bends as necessary.



❑ 14. Move the throttle arm on the carburetor to **half throttle**. With the servo arm on the throttle servo perpendicular to the servo case (pointing up), mark on the pushrod where it crosses the outer hole of the servo arm.



❑ 15. Make a 90 degree bend at your mark and cut the pushrod off 1/4" [6mm] beyond the bend. Hook the pushrod

to the throttle servo arm and secure it with a nylon FasLink. Make any necessary adjustments to the pushrod inside the brass screw-lock connector so that the throttle opens and closes with the servo. Use the radio system to test the operation of the throttle. When satisfied, tighten the screw in the screw-lock connector against the pushrod.

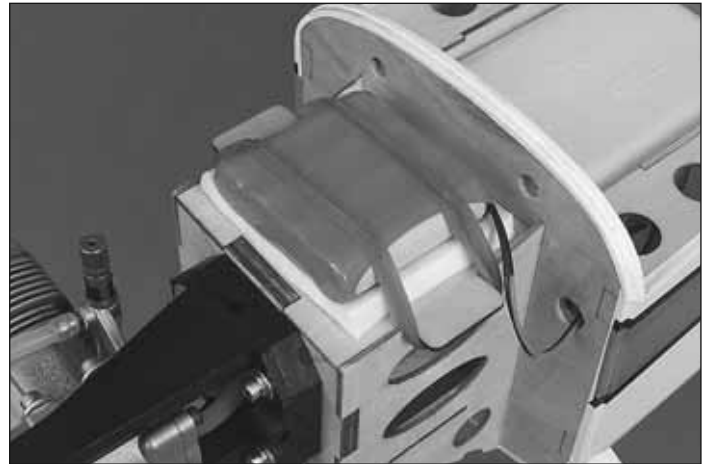

❑ 16. Cut a piece of foam rubber to match your receiver battery pack and strap it to the top of the motor mounting box with rubber bands. There is a hole on the left side of the fuselage for the battery lead.

Brushless Motor Installation

If you have installed a glow engine, skip this section as it only contains information relevant to installing a brushless motor.

Be sure to read and understand the instructions that come with the ESC and motor before attempting to operate the system.

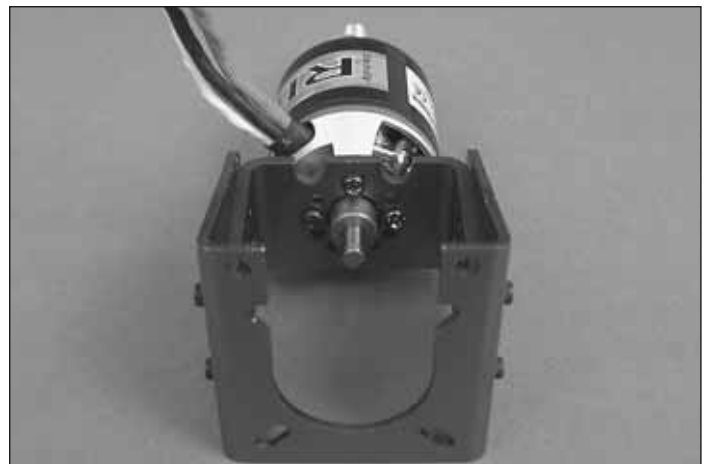

❑ 1. Attach the out-runner motor to the brushless motor mount using the included 3 x 8mm machine screws and thread locking compound. If you haven't done so yet, install the prop adapter to the motor case with the hardware included with the motor and thread locking compound.

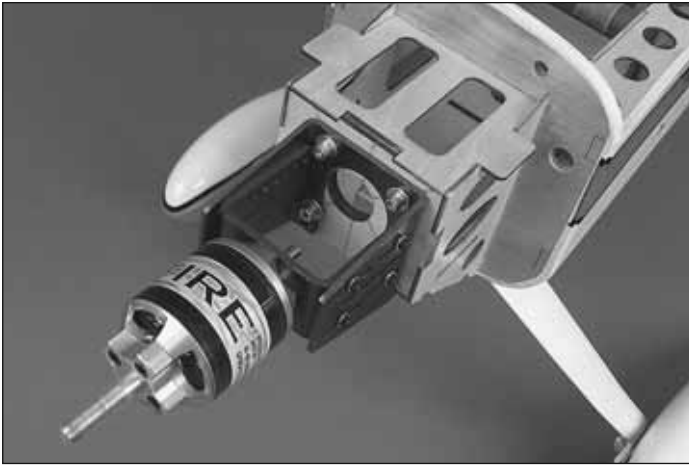

□ 2. Attach the motor mount to the firewall using four 6-32 x 1/2" [13mm] SHCS, four #6 flat washers, four #6 lock washers, and thread locking compound.

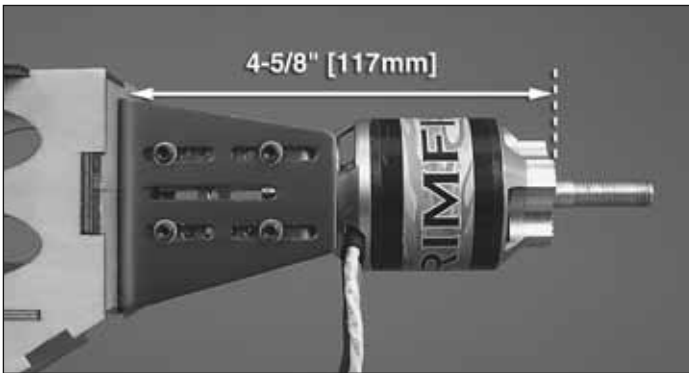

□ 3. Loosen the screws that hold the aluminum motor mount halves together and slide them in together so that the front of the prop adapter is 4-5/8" [117mm] from the firewall. When adjusting the mount, do not inadvertently create any up or down motor thrust angle. Be sure that the center slots in the front and back motor mount halves are aligned together. Use thread locking compound on the screws that join the motor mount halves.



□ 4. Make a hook and loop strap from the included hook and loop material by overlapping the ends of two pieces by approximately 1" [25mm]. The length of the strap will be determined by the size of the ESC you will be using. Insert the strap through the slots in the **ESC tray** as shown.

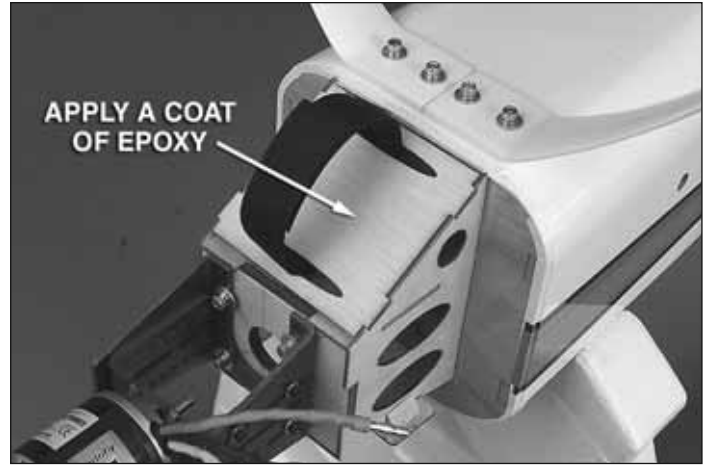

□ 5. Glue the tray into the slots on the underside of the motor mounting box. Brush on a thin coat of epoxy onto the ESC tray between the slots and allow it to cure. The epoxy will provide a smooth surface for the ESC to adhere to.

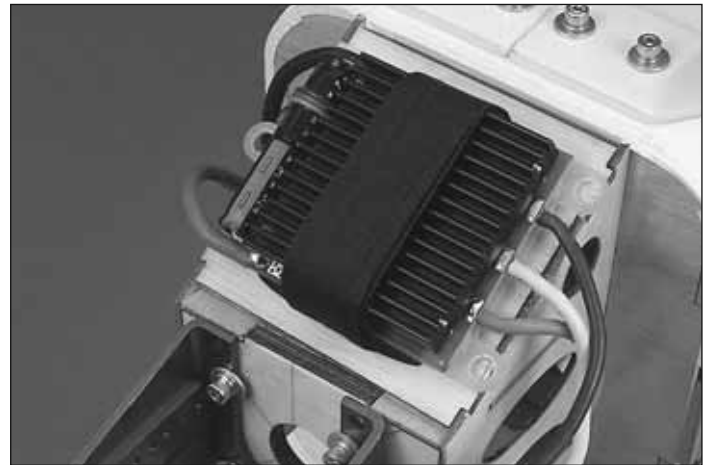

□ 6. Use self-adhesive hook and loop material or double-sided foam servo mounting tape (not included) to attach the ESC to the ESC tray. Use the strap you made to secure it in place. Connect the motor leads to the ESC and feed the receiver lead through the hole in the firewall.

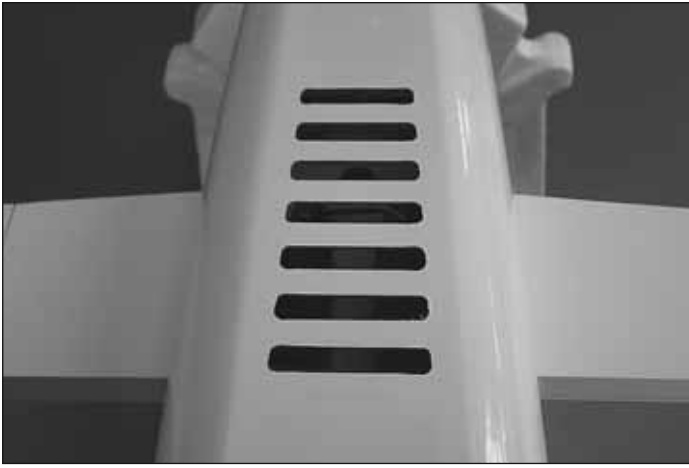

7. Cut the covering from the seven cooling slots on the underside of the fuselage.

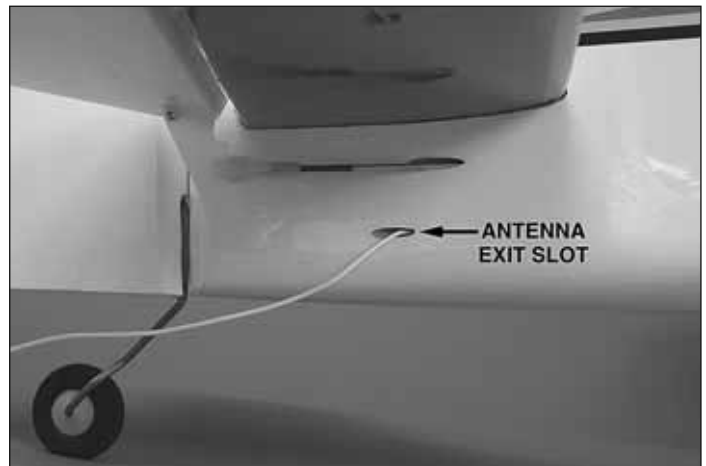
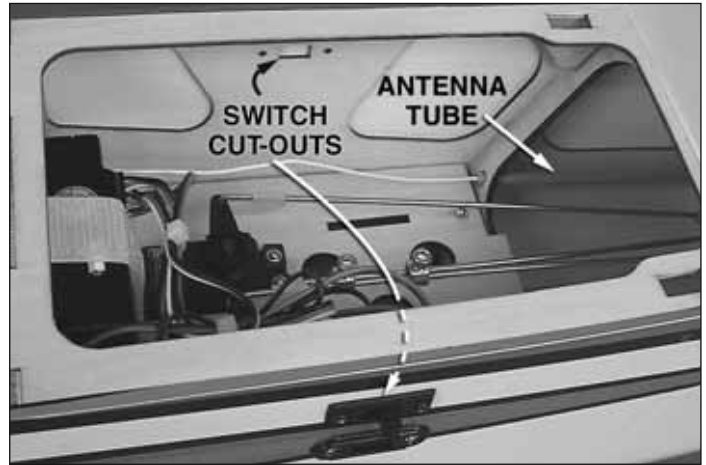
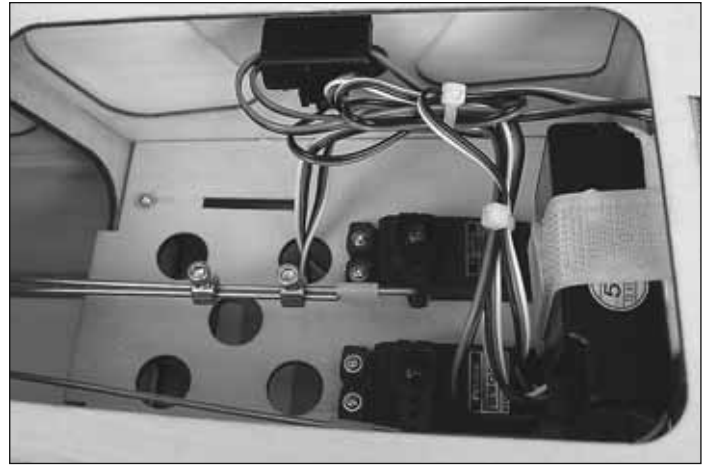

FINISH THE MODEL

Install the Receiver

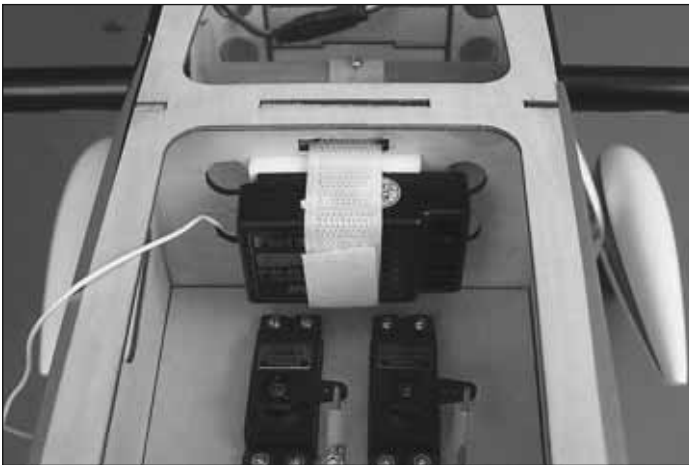

1. Make a strap from the included hook and loop material to fit your receiver. Cut a piece of foam rubber (not included) to fit your receiver and strap the receiver to the former in front of the tail servos as shown.

2. Connect the servos to the receiver being sure that the leads will not interfere with the tail pushrods. Depending on the ESC being used (if applicable), you may need a servo extension to reach the receiver.

3. Pre-cut openings are provided on both sides of the fuselage for mounting an on/off switch. The hole spacing is made for a Futaba mini switch harness. If you are using a different switch, you may need to modify the pre-cut opening, or mount it in a different location. An optional charge jack receptacle can be mounted below the switch. Feed the receiver antenna through the antenna tube pre-installed in the fuselage. Cut the covering from the antenna tube exit slot at the back of the fuselage and pull the antenna out. Be sure that the receiver antenna will not interfere with the tail pushrods.

Install the Cowl



❑ 1. Before fitting the cowl, make any cutouts necessary for your power system. If you are installing a glow engine, a cutout must be made for the engine head, exhaust outlets, and needle valve access. The picture here shows a cutout for the ESC in a brushless motor installation which will also double as a cooling hole. A rotary tool such as a Dremel works very well for cutting holes in fiberglass.



❑ 3. Fit the cowl to the fuselage and align it with the colors on the fuselage. Temporarily install the spinner backplate onto the motor shaft and make any adjustments to the cowl position so that the backplate is centered with the front of the cowl. When satisfied, tape the cowl into position. Measure $3/8$ " [9.5mm] forward from the aft end of the cowl at each mark you made on the masking tape. Mark the cowl for each of the four cowl mounting screws.



❑ 4. Drill $1/16$ " [1.6mm] holes at the marks you made on the cowl through the cowl mounting blocks. Remove the cowl and thread a #2 x $1/2$ " [13mm] self-tapping screw into each hole in the cowl mounting blocks and back it out. Apply a couple drops of thin CA to each hole in the blocks. Enlarge the four holes in the cowl with a $3/32$ " [2.4mm] bit. If you are using a brushless motor, now is a good time to confirm the proper rotation of the motor using your radio system and a battery pack. If the motor rotates in the wrong direction, unplug any two of the three motor leads and swap their positions. When satisfied, install the cowl onto the fuselage using four #2 x $1/2$ " [13mm] self-tapping screws, four #2 flat washers, and four #2 lock washers.

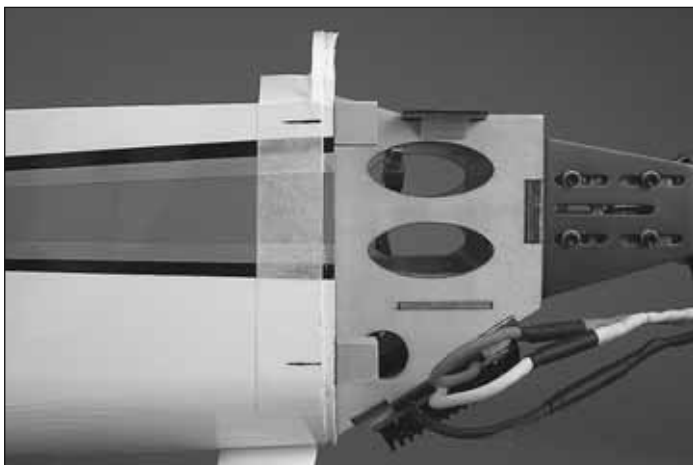

❑ 2. Apply a piece of masking tape to each side of the fuselage in the location shown and mark the location of the middle of each cowl mounting block.

Prepare the Battery Trays (Brushless Installation Only)

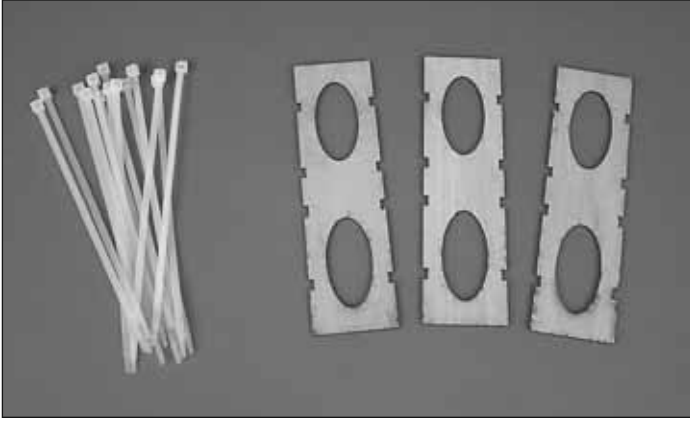

❑ 1. Three **plywood battery trays** and fourteen tie straps are included for creating removable battery packs.

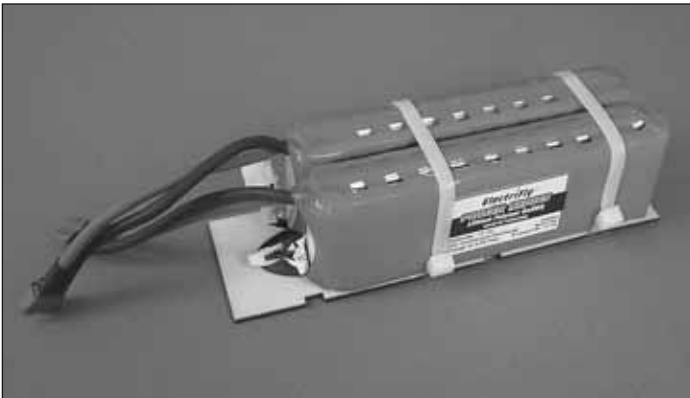

❑ 2. Use two tie straps to secure two 11.1V 3200mAh LiPo batteries to a battery tray. Align the straps in the notches cut into the sides of the tray. The other two trays are provided to make additional removable packs to decrease down time between battery charging.

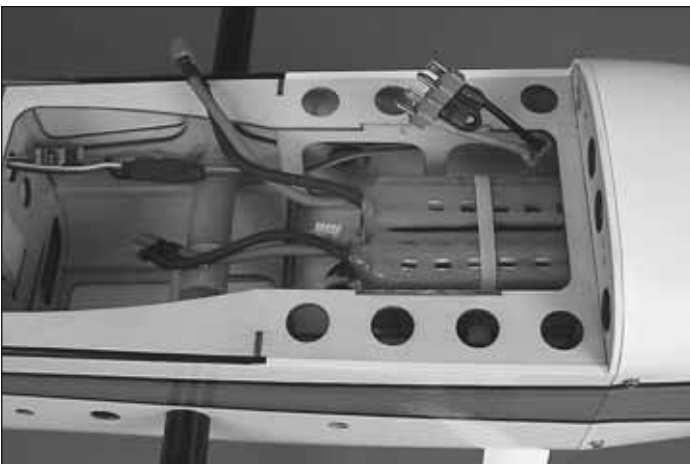

❑ 3. The removable battery pack slides into the fuel tank compartment. The pack will be held down by the canopy hatch during flight. A series connector will be required to connect the two 11.1V packs in series for a total of 22.2V. Use CA to glue a small piece of hook and loop material to the aft end of the battery tray and the back of the fuel tank compartment.

Install the Canopy Hatch and Spinner



❑ 1. Test fit the included pilot figure into the canopy hatch. Trim the shoulder width as necessary for a snug fit. Sand the inside shoulder areas of the pilot with 220-grit sandpaper. When satisfied, apply a bead of medium or thick CA glue along the bottom edge of the pilot figure and fit him in place. Hold him still until the CA tacks. We do not recommend using CA accelerator on the pilot as over spray could cause discoloration of the canopy.



❑ 2. Make a mixture of Top Flite Microballoons and epoxy. Use a mixing stick or something similar to drip the epoxy into the cavities where the pilot figure meets the canopy hatch base as shown. This will help keep the pilot securely in place.

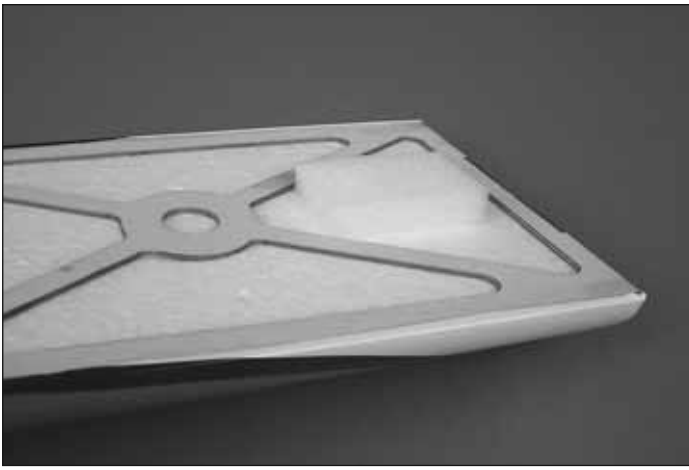

❑ 3. Glue the included foam block to the front underside of the canopy hatch using epoxy or foam safe CA glue.



4-40x3/4" [19mm] SCREW

❑ 4. Fit the canopy hatch in place and install it using two 4-40 x 3/4" [19mm] machine screws, two #4 flat washers, and two #4 lock washers.

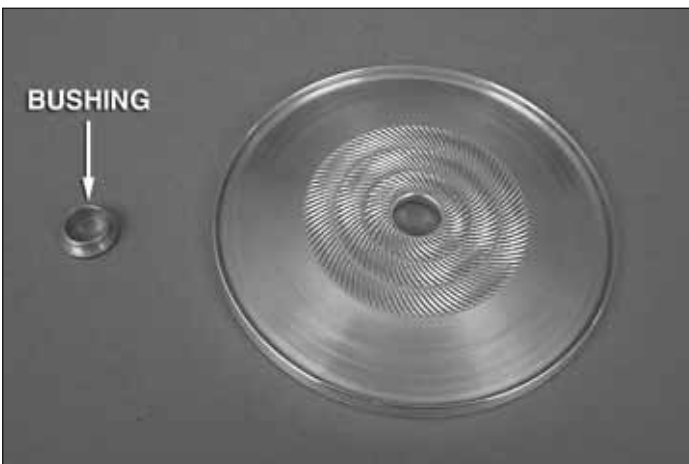

BUSHING

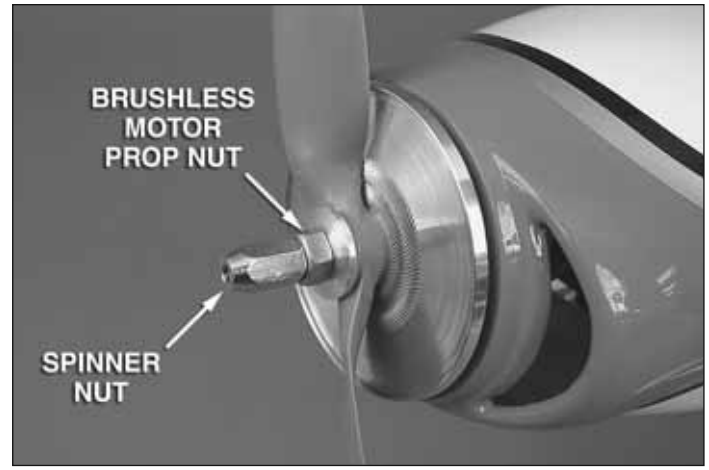

BRUSHLESS
MOTOR
PROP NUT

SPINNER
NUT

❑ 5. The spinner includes a bushing for use with crankshafts or prop adapters that have a 5/16" [7.9mm] thread or 1/4" [6.3mm] thread. Use the bushing that fits your prop shaft. Install the spinner backplate, propeller, and threaded spinner nut that matches your shaft thread size. If you are using the recommended brushless motor, you will also need to install the prop nut included with the motor before the spinner nut.



❑ 6. Install the spinner cone onto the backplate with the 4 x 45mm SHCS.



❑ 7. You have now completed the assembly!

Apply the Decals

1. Use scissors or a sharp hobby knife to cut the decals from the sheet.

2. Be certain the model is clean and free from oily fingerprints and dust. Prepare a dishpan or small bucket with a mixture of liquid dish soap and warm water—about one teaspoon of soap per gallon of water. Submerge the decal in the soap and water and peel off the paper backing. **Note:** Even though the decals have a “sticky-back” and are not the water transfer type, submersing them in soap & water allows accurate positioning and reduces air bubbles underneath.

3. Position decal on the model where desired. Holding the decal down, use a paper towel to wipe most of the water away.

4. Use a piece of soft balsa or something similar to squeegee remaining water from under the decal. Apply the rest of the decals the same way.

GET THE MODEL READY TO FLY

Install and Operate the Motor Battery (Brushless Motor Only)

IMPORTANT: If using multiple battery packs that are connected with an adapter, never charge the batteries together through the adapter. Always charge each battery pack separately. Charge the batteries, then read the following precautions on how to connect multiple packs for flying the model:

BATTERY PRECAUTIONS:

There are two ways to connect multiple battery packs: In **Series** and in **Parallel**.

These are two 3200mAh batteries (one 11.1V and the other 7.4V). When joined in **SERIES**, the result will be a 18.5V, 3200mAh battery.

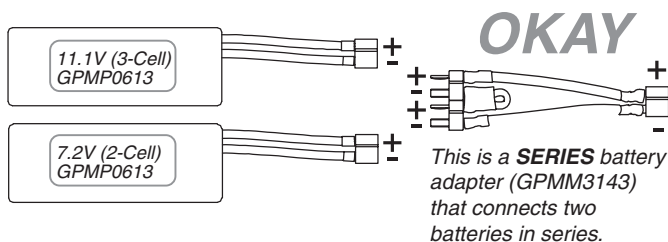

It's okay to connect batteries with different voltages in series to achieve the new, desired voltage.

1. Connecting batteries in “**Series**” means to connect the (+)'s to the (-)'s and the (-)'s to the (+)'s. This combines the voltages of the batteries, but the capacity remains the same.

These two 1500mAh batteries (both 11.1V) are being joined in **PARALLEL**. The result will be one **11.1V, 3000mAh** battery.

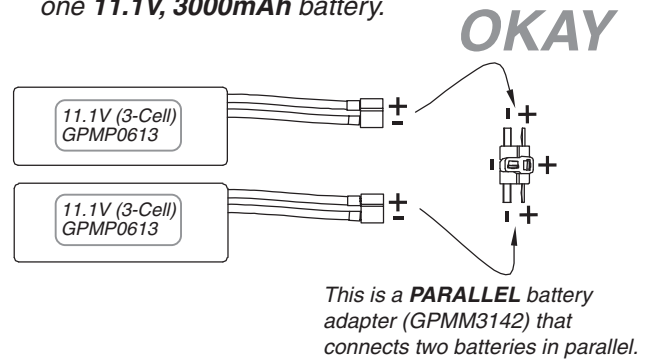

2. Connecting batteries in “**Parallel**” means to connect the (+)'s to the (+)'s and the (-)'s to the (-)'s. This combines the capacities of the batteries, but the voltage remains the same.

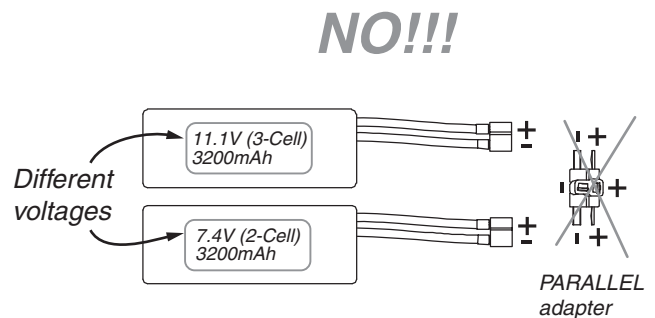

NEVER connect battery packs with different voltages in parallel! Only combine them in series. Otherwise, the batteries with lower voltage will try to “equalize” with the batteries that have a higher voltage. Current will flow from the higher voltage battery into the lower one, essentially “charging” the lower voltage battery pack. This situation will likely cause heat and possibly a fire.

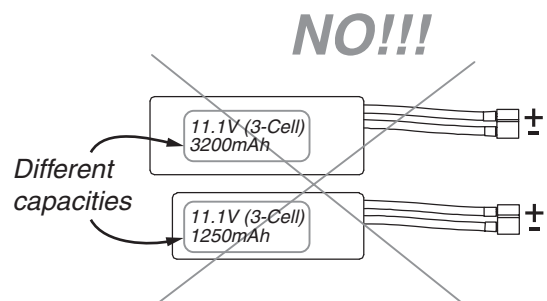

NEVER connect battery packs with different capacities in series or in parallel.

Check the Control Directions

- ❑ 1. Turn on the transmitter and receiver and center the trims. If necessary, remove the servo arms from the servos and reposition them so they are centered. Reinstall the screws that hold on the servo arms.
- ❑ 2. With the transmitter and receiver still on, check all the control surfaces to see if they are centered. If necessary, adjust the clevises on the pushrods to center the control surfaces.

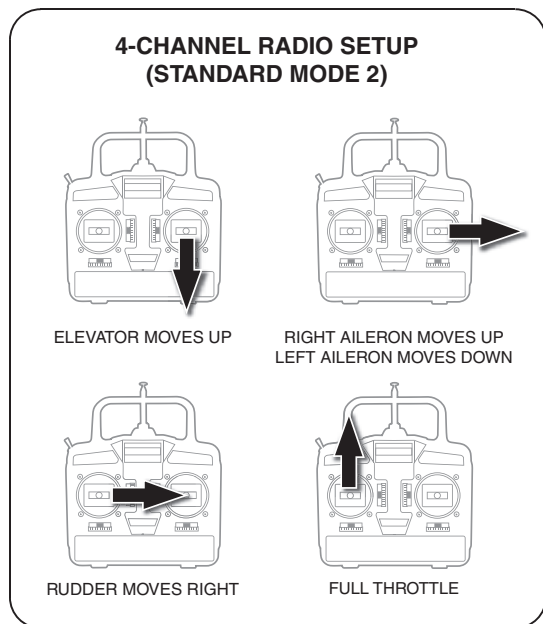

- ❑ 3. Make certain that the control surfaces and the carburetor respond in the correct direction as shown in the diagram. If any of the controls respond in the wrong direction, use the servo reversing in the transmitter to reverse the servos connected to those controls. Be certain the control surfaces have remained centered. Adjust if necessary.

Set the Control Throws



Use a Great Planes AccuThrow (or a ruler) to accurately measure and set the control throw of each control surface as indicated in the chart that follows. If your radio does not have dual rates, we recommend setting the throws at the **low** rate setting.

These are the recommended control surface throws:

	High Rate	Low Rate
ELEVATOR:	1/2" [13mm] up 1/2" [13mm] down	5/16" [8mm] up 5/16" [8mm] down
RUDDER:	2-1/4" [57mm] right 2-1/4" [57mm] left	1-3/8" [35mm] right 1-3/8" [35mm] left
AILERONS:	3/8" [10mm] up 3/8" [10mm] down	1/4" [6mm] up 1/4" [6mm] down

NOTE: The throws are measured at the **widest part** of the elevators, rudder and ailerons.

IMPORTANT: The Revolver ARF has been **extensively** flown and tested to arrive at the throws at which it flies best. Flying your model at these throws will provide you with the greatest chance for successful first flights. If, after you have become accustomed to the way the Revolver flies, you would like to change the throws to suit your taste, that is fine. However, too much control throw could make the model difficult to control, so remember, "more is not always better."

Balance the Model (C.G.)

More than any other factor, the **C.G.** (balance point) can have the **greatest** effect on how a model flies, and may determine whether or not your first flight will be successful. If you value this model and wish to enjoy it for many flights, **DO NOT OVERLOOK THIS IMPORTANT PROCEDURE.** A model that is not properly balanced will be unstable and possibly unflyable.

At this stage the model should be in ready-to-fly condition with all of the systems in place including the engine or brushless motor, landing gear, and the radio system (and battery pack if applicable).

- ❑ 1. Use a felt-tip pen or 1/8" [3mm]-wide tape to accurately mark the C.G. on the top of the wing on both sides of the fuselage. **The C.G. is located 4-15/16" [110mm] back from the leading edge of the wing at the fuselage.**

This is where your model should balance for the first flights. Later, you may wish to experiment by shifting the C.G. up to 5/16" [8mm] forward or 5/16" [8mm] back to change the flying characteristics. Moving the C.G. forward may improve the smoothness and stability, but the model may then require more speed for takeoff and make it more difficult to slow for landing. Moving the C.G. aft makes the model more maneuverable, but could also cause it to become too difficult to control. In any case, **start at the recommended balance point** and do not at any time balance the model outside the specified range.

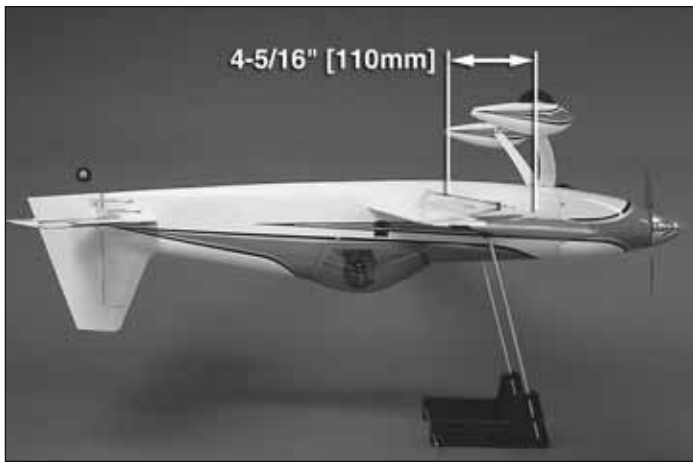

2. With the wing attached to the fuselage, all parts of the model installed (ready to fly) and an empty fuel tank, place the model upside-down on a Great Planes CG Machine, or lift it upside-down at the balance point you marked.

3. If the tail drops, the model is “tail heavy” and the battery pack and/or receiver must be shifted forward or weight must be added to the nose to balance. If the nose drops, the model is “nose heavy” and the battery pack and/or receiver must be shifted aft or weight must be added to the tail to balance. If possible, relocate the battery pack and receiver to minimize or eliminate any additional ballast required. If additional weight is required, nose weight may be easily added by using a “spinner weight” (GPMQ4645 for the 1 oz. [28g] weight, or GPMQ4646 for the 2 oz. [57g] weight). If spinner weight is not practical or is not enough, use Great Planes (GPMQ4485) “stick-on” lead. A good place to add stick-on nose weight is to the firewall (don’t attach weight to the cowl—it is not intended to support weight). Begin by placing incrementally increasing amounts of weight on the bottom of the fuse over the firewall until the model balances. Once you have determined the amount of weight required, it can be permanently attached. If required, tail weight may be added by cutting open the bottom of the fuse and gluing it permanently inside.

Note: Do not rely upon the adhesive on the back of the lead weight to permanently hold it in place. Over time, fuel and exhaust residue may soften the adhesive and cause the weight to fall off. Use #2 sheet metal screws, RTV silicone or epoxy to permanently hold the weight in place.

4. **IMPORTANT:** If you found it necessary to add any weight, recheck the C.G. after the weight has been installed.

Balance the Model Laterally

1. With the wing level, have an assistant help you lift the model by the engine propeller shaft and the bottom of the fuse under the TE of the fin. Do this several times.

2. If one wing always drops when you lift the model, it means that side is heavy. Balance the airplane by adding weight to the other wing tip. **An airplane that has been laterally balanced will track better in loops and other maneuvers.**

PREFLIGHT

Identify Your Model

No matter if you fly at an AMA sanctioned R/C club site or if you fly somewhere on your own, you should always have your name, address, telephone number and AMA number on or inside your model. It is **required** at all AMA R/C club flying sites and AMA sanctioned flying events. Fill out the identification tag on page 31 (or on the decal sheet) and place it on or inside your model.

Charge the Batteries

Follow the battery charging instructions that came with your radio control system to charge the batteries. You should always charge your transmitter and receiver batteries the night before you go flying, and at other times as recommended by the radio manufacturer.

CAUTION: Unless the instructions that came with your radio system state differently, the **initial** charge on **new** transmitter and receiver batteries should be done for 15 hours **using the slow-charger that came with the radio system**. This will “condition” the batteries so that the next charge may be done using the fast-charger of your choice. If the initial charge is done with a fast-charger the batteries may not reach their full capacity and you may be flying with batteries that are only partially charged.

Balance Propellers

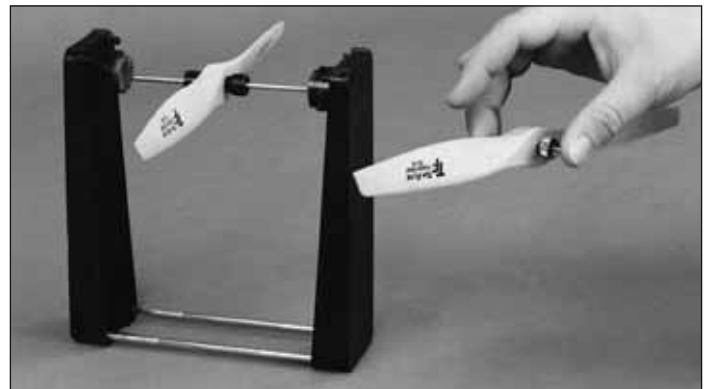

Carefully balance your propeller and spare propellers before you fly. An unbalanced prop can be the single most significant cause of vibration that can damage your model. Not only will engine mounting screws and bolts loosen, possibly with disastrous effect, but vibration may also damage your radio receiver and battery. Vibration can also cause your fuel to foam, which will, in turn, cause your engine to run hot or quit.

We use a Top Flite Precision Magnetic Prop Balancer (TOPQ5700) in the workshop and keep a Great Planes Fingertip Prop Balancer (GPMQ5000) in our flight box.

Ground Check

If the engine is new, follow the engine manufacturer's instructions to break-in the engine. After break-in, confirm that the engine idles reliably, transitions smoothly and rapidly to full power and maintains full power—indefinitely. After you run the engine on the model, inspect the model closely to make sure all screws remained tight, the hinges are secure, the prop is secure and all pushrods and connectors are secure.

Range Check

Ground check the operational range of your radio before the first flight of the day. With the transmitter antenna collapsed and the receiver and transmitter on, you should be able to walk at least 100 feet away from the model and still have control. Have an assistant stand by your model and, while you work the controls, tell you what the control surfaces are doing. Repeat this test **with the engine running** at various speeds with an assistant holding the model, using hand signals to show you what is happening. If the control surfaces do not respond correctly, **do not fly!** Find and correct the problem first. Look for loose servo connections or broken wires, corroded wires on old servo connectors, poor solder joints in your battery pack or a defective cell, or a damaged receiver crystal from a previous crash.

ENGINE SAFETY PRECAUTIONS

Failure to follow these safety precautions may result in severe injury to yourself and others.

- Keep all engine fuel in a safe place, away from high heat, sparks or flames, as fuel is very flammable. Do not smoke near the engine or fuel; and remember that engine exhaust gives off a great deal of deadly carbon monoxide. Therefore **do not run the engine in a closed room or garage.**
- Get help from an experienced pilot when learning to operate engines.
- Use safety glasses when starting or running engines.
- Do not run the engine in an area of loose gravel or sand; the propeller may throw such material in your face or eyes.
- Keep your face and body as well as all spectators away from the plane of rotation of the propeller as you start and run the engine.
- Keep these items away from the prop: loose clothing, shirt sleeves, ties, scarves, long hair or loose objects such as pencils or screwdrivers that may fall out of shirt or jacket pockets into the prop.

- Use a “chicken stick” or electric starter to start the engine. Do not use your fingers to flip the propeller. Make certain the glow plug clip or connector is secure so that it will not pop off or otherwise get into the running propeller.
- Make all engine adjustments from behind the rotating propeller.
- The engine gets hot! Do not touch it during or right after operation. Make sure fuel lines are in good condition so fuel will not leak onto a hot engine, causing a fire.
- To stop a glow engine, cut off the fuel supply by closing off the fuel line or following the engine manufacturer's recommendations. Do not use hands, fingers or any other body part to try to stop the engine. To stop a gasoline powered engine an on/off switch should be connected to the engine coil. Do not throw anything into the propeller of a running engine.

LITHIUM BATTERY HANDLING & USAGE

WARNING!! Read the entire instruction sheet included with the battery. Failure to follow all instructions could cause permanent damage to the battery and its surroundings, and cause bodily harm!

- ONLY use a LiPo approved charger. NEVER use a NiCd/ NiMH peak charger!
- NEVER charge in excess of 4.20V per cell.
- ONLY charge through the “charge” lead. NEVER charge through the “discharge” lead.
- NEVER charge at currents greater than 1C.
- ALWAYS set charger's output volts to match battery volts.
- ALWAYS charge in a fireproof location.
- NEVER trickle charge.
- NEVER allow battery temperature to exceed 150° F (65° C).
- NEVER disassemble or modify pack wiring in any way or puncture cells.
- NEVER discharge below 2.5V per cell.
- NEVER place on combustible materials or leave unattended during charge or discharge.
- ALWAYS KEEP OUT OF REACH OF CHILDREN.

AMA SAFETY CODE (EXCERPTS)

Read and abide by the following excerpts from the Academy of Model Aeronautics Safety Code. For the complete Safety Code refer to *Model Aviation* magazine, the AMA web site or the Code that came with your AMA license.

General

- 1) I will not fly my model aircraft in sanctioned events, air shows, or model flying demonstrations until it has been proven to be airworthy by having been previously, successfully flight tested.
- 2) I will not fly my model aircraft higher than approximately 400 feet within 3 miles of an airport without notifying the airport operator. I will give right-of-way and avoid flying in the proximity of full-scale aircraft. Where necessary, an observer shall be utilized to supervise flying to avoid having models fly in the proximity of full-scale aircraft.
- 3) Where established, I will abide by the safety rules for the flying site I use, and I will not willfully and deliberately fly my models in a careless, reckless and/or dangerous manner.
- 5) I will not fly my model unless it is identified with my name and address or AMA number, on or in the model. Note: This does not apply to models while being flown indoors.
- 7) I will not operate models with pyrotechnics (any device that explodes, burns, or propels a projectile of any kind).

Radio Control

- 1) I will have completed a successful radio equipment ground check before the first flight of a new or repaired model.
- 2) I will not fly my model aircraft in the presence of spectators until I become a qualified flier, unless assisted by an experienced helper.
- 3) At all flying sites a straight or curved line(s) must be established in front of which all flying takes place with the other side for spectators. Only personnel involved with flying the aircraft are allowed at or in the front of the flight line. Intentional flying behind the flight line is prohibited.
- 4) I will operate my model using only radio control frequencies currently allowed by the Federal Communications Commission.
- 5) **I will not knowingly operate my model within three miles of any pre-existing flying site except in accordance with the frequency sharing agreement listed** [in the complete AMA Safety Code].
- 9) Under no circumstances may a pilot or other person touch a powered model in flight; **nor should any part of the model other than the landing gear, intentionally touch the ground, except while landing.**

CHECK LIST

During the last few moments of preparation your mind may be elsewhere anticipating the excitement of the first flight. Because of this, you may be more likely to overlook certain checks and procedures that should be performed before the model is flown. To help avoid this, a check list is provided to make sure these important areas are not overlooked. Many are covered in the instruction manual, so where appropriate, refer to the manual for complete instructions. Be sure to check the items off as they are completed.

1. Check the C.G. according to the measurements provided in the manual.
2. Be certain the battery and receiver are securely mounted in the fuse. Simply stuffing them into place with foam rubber is not sufficient.
3. Extend your receiver antenna.
4. Balance your model laterally as explained in the instructions.
5. Use threadlocking compound to secure critical fasteners such as the set screws that hold the wheel axles to the struts, screws that hold the carburetor arm (if applicable), screw-lock pushrod connectors, etc.
6. Add a drop of oil to the axles so the wheels will turn freely.
7. Make sure all hinges are securely glued in place.
8. Reinforce holes for wood screws with thin CA where appropriate (servo mounting screws, cowl mounting screws, etc.).
9. Confirm that all controls operate in the correct direction and the throws are set up according to the manual.
10. Make sure there are silicone retainers on all the clevises and that all servo arms are secured to the servos with the screws included with your radio.
11. Secure connections between servo wires and Y-connectors or servo extensions, and the connection between your battery pack and the on/off switch with vinyl tape, heat shrink tubing or special clips suitable for that purpose.
12. Make sure any servo extension cords you may have used do not interfere with other systems (servo arms, pushrods, etc.).
13. Secure the pressure tap (if used) to the muffler with high temp RTV silicone, thread locking compound or J.B. Weld.
14. Make sure the fuel lines are connected and are not kinked.
15. Balance your propeller (and spare propellers).
16. Tighten the propeller nut and spinner.
17. Place your name, address, AMA number and telephone number on or inside your model.
18. Cycle your receiver battery pack (if necessary) and make sure it is fully charged.
19. If you wish to photograph your model, do so before your first flight.
20. Range check your radio when you get to the flying field.

FLYING

The Revolver .46 ARF is a great-flying model that flies smoothly and predictably. The Revolver does not, however, possess the self-recovery characteristics of a primary R/C trainer and should be flown only by experienced R/C pilots.

Fuel Mixture Adjustments

A fully cowled engine may run at a higher temperature than an un-cowled engine. For this reason, the fuel mixture should be richened so the engine runs at about 200 rpm below peak speed. By running the engine slightly rich, you will help prevent dead-stick landings caused by overheating.

CAUTION (THIS APPLIES TO ALL R/C AIRPLANES):

If, while flying, you notice an alarming or unusual sound such as a low-pitched "buzz," this may indicate control surface *flutter*. Flutter occurs when a control surface (such as an aileron or elevator) or a flying surface (such as a wing or stab) rapidly vibrates up and down (thus causing the noise). In extreme cases, if not detected immediately, flutter can actually cause the control surface to detach or the flying surface to fail, thus causing loss of control followed by an impending crash. The best thing to do when flutter is detected is to slow the model **immediately** by reducing power, then land as soon as safely possible. Identify which surface fluttered (so the problem may be resolved) by checking all the servo grommets for deterioration or signs of vibration. Make certain all pushrod linkages are secure and free of play. If it fluttered once, under similar circumstances it will probably flutter again unless the problem is fixed. Some things which can cause flutter are; Excessive hinge gap; Not mounting control horns solidly; Poor fit of clevis pin in horn; Side-play of wire pushrods caused by large bends; Excessive free play in servo gears; Insecure servo mounting; and one of the most prevalent causes of flutter; Flying an over-powered model at excessive speeds.

Takeoff

Before you get ready to takeoff, see how the model handles on the ground by doing a few practice runs at **low speeds** on the runway. Hold "up" elevator to keep the tail wheel on the ground. If necessary, adjust the tail wheel so the model will roll straight down the runway. If you need to calm your nerves before the maiden flight, shut the engine down and bring the model back into the pits. Top off the fuel, then check all fasteners and control linkages for peace of mind.

Remember to takeoff into the wind. When you're ready, point the model straight down the runway, hold a bit of up elevator to keep the tail on the ground to maintain tail wheel steering, then gradually advance the throttle. As the model gains speed decrease up elevator allowing the tail to

come off the ground. One of the most important things to remember with a tail dragger is to always be ready to apply **right** rudder to counteract engine torque. Gain as much speed as your runway and flying site will practically allow before gently applying up elevator, lifting the model into the air. At this moment it is likely that you will need to apply more right rudder to counteract engine torque. Be smooth on the elevator stick, allowing the model to establish a **gentle** climb to a safe altitude before turning into the traffic pattern.

Flight

For reassurance and to keep an eye on other traffic, it is a good idea to have an assistant on the flight line with you. Tell him to remind you to throttle back once the plane gets to a comfortable altitude. While full throttle is usually desirable for takeoff, most models fly more smoothly at reduced speeds.

Take it easy with the Revolver for the first few flights, gradually getting acquainted with it as you gain confidence. Adjust the trims to maintain straight and level flight. If you have powered the airplane with a .40 engine, you will find the plane fast, but not so fast to get yourself in trouble. If you have powered it with a .55 engine, the airplane becomes very fast so be sure to get fully acquainted with how it performs before attempting complex maneuvers that could get you into trouble. After flying around for a while and while still at a safe altitude with plenty of fuel, practice slow flight and execute practice landing approaches by reducing the throttle to see how the model handles at slower speeds. Add power to see how the model climbs as well. Continue to fly around, executing various maneuvers and making mental notes (or having your assistant write them down) of what trim or C.G. changes may be required to fine tune the model so it flies the way you like. Mind your fuel level, but use this first flight to become familiar with your model before landing.

Landing

The Revolver is a very clean airframe. Because of this, you will find that it takes longer to slow the plane for landing than some other airplanes you have flown. Be prepared for this and don't be surprised if you have to go around and set up for your landing a second time. Practice your landing approach at a higher altitude over the runway to familiarize yourself with the low speed characteristics of the plane. To initiate a landing approach, lower the throttle while on the downwind leg. Allow the nose of the model to pitch downward to gradually bleed off altitude. Continue to lose altitude, but maintain airspeed by keeping the nose down as you turn onto the crosswind leg. Make your final turn toward the runway (into the wind) keeping the nose down to maintain airspeed and control. Level the attitude when the model reaches the runway threshold, modulating the throttle as necessary to maintain your glide path and airspeed. If you are going to overshoot, smoothly advance the throttle (always ready on the right rudder to counteract torque) and climb out to make another attempt.

When you're ready to make your landing flare and the model is a foot or so off the deck, smoothly increase up elevator until it gently touches down. Once the model is on the runway and has lost flying speed, hold up elevator to place the tail on the ground, regaining tail wheel control.

One final note about flying your model. Have a goal or flight plan in mind for **every** flight. This can be learning a new maneuver(s), improving a maneuver(s) you already know, or learning how the model behaves in certain conditions (such as on high or low rates). This is not necessarily to improve your skills (*though it is never a bad idea!*), but more importantly so you do not surprise yourself by impulsively attempting a maneuver and suddenly finding that you've run out of time, altitude or airspeed. Every maneuver should be deliberate, not impulsive. For example, if you're going to do a loop, check your altitude, mind the wind direction (anticipating rudder corrections that will be required to maintain heading), remember to throttle back at the top, and make certain you are on the desired rates (high/low rates). A flight plan greatly reduces the chances of crashing your model just because of poor planning and impulsive moves. **Remember to think.**

Have a ball!

But always stay in control and fly in a safe manner.

GOOD LUCK AND GREAT FLYING!

This model belongs to:

Name

Address

City, State Zip

Phone number

AMA number

OTHER ITEMS AVAILABLE FROM GREAT PLANES

REACTOR

Wingspan: 58 in (1475 mm)
Wing Area: 745 sq in (48.1 dm²)
Weight: 5.25 - 6.25 lb (2.41 - 2.72 kg)
Wing Loading: 16 - 18 oz/sq ft (50-57 g/dm²)
Length: 59 in (1500 mm)

Requires:

Radio: 4+ channel radio w/5 mini servos (50 oz-in of torque, min.)
Electric Power Option: Brushless out-runner motor, 60A brushless ESC, two 11.1V, 3200mAh LiPo batteries (in series) and charger
Glow Power Option: 2-stroke .46-.51 or 4-stroke .70 engine, 1 additional servo, glow fuel and support equipment



Precision pattern plane — or all-out 3D aerobat? You decide. The Reactor excels at both. It doesn't matter whether you go with glow power or equip it with a brushless electric motor — you'll enjoy outstanding performance either way, thanks to its all-wood construction for light, strong structures, and a pure sport design with none of the compromises that scale planes require. The result: a rocket-sleek plane with maxed-out performance potential. The mid-wing design and thin airfoil (9% thick vs. 13-14%) offer exceptional precision and a wide performance envelope, plus confidence-inspiring stability at slow speeds. Assembly is anything but slow — prebuilt structures, MonoKote covering and painted fiberglass parts cut it to just 5-6 hours, start to finish. **GPMA1021**

POLYCHARGE4

FOUR-OUTPUT LITHIUM-POLYMER CHARGER



For convenience with multiple LiPo packs, there's the DC PolyCharge4. Each of its four independent outputs can charge a one-to-four cell Lithium-Polymer pack. It's ideal if you don't have the time for one-at-a-time charging - and don't want the expense and hassle of multiple chargers. Each output can handle packs from 300 to 3000mAh. Set the capacity, and PolyCharge4 will automatically set the charge rate to get you started — and use light and sound cues to tell you when your pack is done. **GPMM3015**

ElectriFly™



Equinox

By regulating the voltage levels from 2 to 5 LiPo cells to within a very tight tolerance of each other, the Equinox ensures the fullest possible safe voltage during charging — which means more power and longer lasting packs! It can handle a maximum current of 3 amps during charge or discharge (up to 6 amps with custom connectors), and includes adapters for 2S and 3S (7.4V & 11.1V) batteries and gold-plated banana plugs. Plus, it automatically checks for poor quality cells, and provides a safe platform for charging*. Choose from two modes for using Equinox: connected directly to the cell in "Quick Balance" mode, or in conjunction with a LiPo-compatible charger/discharge in "Interface" mode.

*Equinox cannot be used with LiPo batteries which have built-in charge protection circuits.