

# EAGLE 2



## INSTRUCTIONS

*Welcome to the sport of Radio Control flying!*

Congratulations on selecting the Mark II Eagle--today's top trainer and all around sport model. Many new improvements make the Mark II even easier to build and fly than past versions of the Eagle.

It may seem a bit early to speak of flying, but your successful first flight begins right here. Before starting assembly, please read carefully through this instruction booklet. It won't take that long, and building your model and installing your equipment will seem easier, since you will know where you are going.

## WARNING

While this aircraft is an excellent first choice for novice pilots, a radio-controlled model is not a toy and is not intended for persons under 16 years old. Keep this kit out of the reach of younger children, as it contains parts that could be dangerous. A radio-controlled model is capable of causing serious bodily injury and property damage. It is the buyer's responsibility to build this kit correctly and to properly install the motor, radio, and all other equipment. Test and fly the finished model only in the presence and with the assistance of another experienced R/C flyer. The model must always be operated and flown using great care and common sense, as well as in accordance with the Safety Code of the Academy of Model Aeronautics (5151 Memorial Drive, Muncie, IN 47302), 1-800-435-9262). We suggest you join the AMA and become properly insured prior to flying this model. Also, consult with the AMA or your local hobby dealer to find an experienced instructor in your area. Per the Federal Communications Commission, you are required to use only those radio frequencies specified "for Model Aircraft".

---

# CARL GOLDBERG PRODUCTS, LTD.

---

## ITEMS NEEDED TO COMPLETE THIS KIT

- 1 RADIO GUIDANCE SYSTEMS (3 to 4-CHANNEL REQUIRED)
- 1 .29 to .45 2-CYCLE OR .40 to .60 4-CYCLE R/C ENGINE
- PROPELLER, FUEL TANK & TUBING TO SUIT ENGINE
- 1 2-1/4" **CGP** SNAP-ON SPINNER
- 1 2-1/4" WHEEL\*
- 2 2-1/2" WHEELS\*
- 1 2 OZ. BOTTLE CA GLUE
- 1 CA ACCELERATOR
- 1 20 MINUTE EPOXY
- 1 TUB Balsa TINTED **CGP** FILLER
- 2 ROLLS IRON ON COVERING
- 1 1/2" x 8" x 12" **CGP FOAM RUBBER**
- 1/16" x 1/4" WING SEATING TAPE
- FUEL PROOF PAINT

OPTIONAL: ITEMS FOR BOLT-ON WING OPTION DESCRIBED LATER IN BOOK, 4" SILICONE TUBING FOR EXHAUST EXTENSION; ART ACRYLIC PAINT FOR PILOT FIGURE, 1/4" **CGP ULTRASTRIPE** FOR DETAILING, **CGP SCUFF GUARD** TO PROTECT TAIL FROM SCRATCHES.

\* Use next larger size wheel if flying from tall grass.

## NECESSARY TOOLS AND SUPPLIES.

- MISCELLANEOUS RUBBER BANDS, PLUS A BOX OF #64 RUBBER BANDS
- WAXED PAPER
- MODELING KNIFE AND RAZOR BLADES
- SANDPAPER (ASSORTED GRITS, INCLUDING **COARSE (80)**, **MEDIUM (150)** AND **FINE (220-320)**)
- SANDING BLOCK
- "T" PINS (at least 75)
- FLAT BUILDING BOARD(24"x60") SOFT ENOUGH TO PUSH PINS INTO
- ELECTRIC DRILL AND ASSORTED DRILL BITS (1/16", 1/8" & 3/16")
- SCISSORS
- SMALL SCREWDRIVER (1/8" x 3/16" BLADE TIP)
- ALLEN WRENCHES (1/16" & 7/64")
- MASKING TAPE
- LONG NOSE PLIERS
- COVERING IRON AND HEAT GUN

**OPTIONAL:** **CGP** ENGINE TEST STAND, PROP BALANCER, PROP/GLO-PLUG WRENCH, **CGP** HINGE SLOTTING KIT.

## SELECTING RADIO CONTROL EQUIPMENT

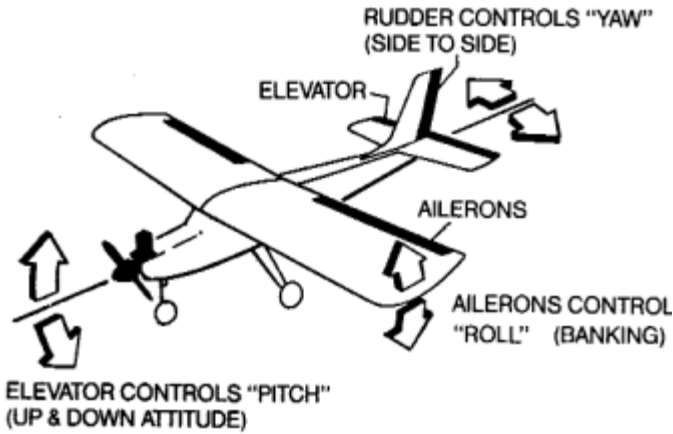

Your model was designed to use three or four-channel radio control equipment. In flight, the model is primarily controlled by using the ailerons and elevator (see sketch at left). One radio channel controls the ailerons. This is the primary turn control - it rolls the model. Another channel operates the elevator which controls pitch (climbing, level flight and descent). The third channel is for the engine throttle and controls the engine speed. A fourth channel is used for rudder which assists the ailerons for turning. The new R/C flyer will probably only use the rudder for steering the model on the ground. Note: for three-channel flying, ailerons are not used and the rudder becomes the primary turn control.

DIGITAL PROPORTIONAL  
RADIO CONTROL

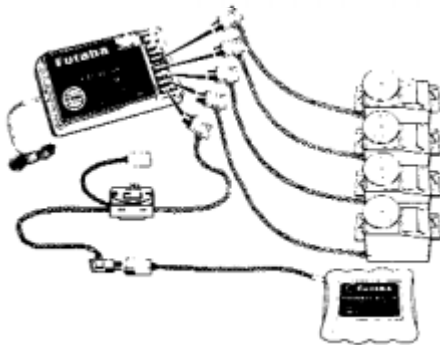

Radio sets are battery powered with either dry cells (small flashlight type batteries) or more reliable rechargeable nickel-cadmium batteries (ni-cads). Sets powered with ni-cads come equipped with a recharging unit, and are more expensive than dry-cells sets. However, if you intend to do a lot of flying, the cost of routinely replacing worn out dry cell batteries will be much greater than the higher initial cost of a re-chargeable ni-cad radio system; something to consider. Many of the radio systems now available feature "servo reversing" switches which allow you to reverse the response of the servo. This feature simplifies radio installation and is a worthwhile consideration when selecting a radio system. You may find radios with more sophisticated features such as dual rates, exponential and control mixing, etc. These features are not needed for general sport flying, and are typically used by more advanced flyers.

When selecting a radio, remember that there are many radio frequencies available. Not all of these frequencies can be legally used to operate model airplanes. Tell your dealer that you want a radio with a model "Airplane" frequency.

ONE OF MANY SYSTEMS AVAILABLE,  
PLEASE SEE YOUR LOCAL DEALER OR  
CLUB FOR ADVICE ON SELECTING  
YOUR RADIO.

**WARNING:** Per the Federal Communications Commission there is only one group of frequencies designated for radio control aircraft use. According to the law, it is your responsibility to use the designated aircraft frequencies to operate your model airplane.

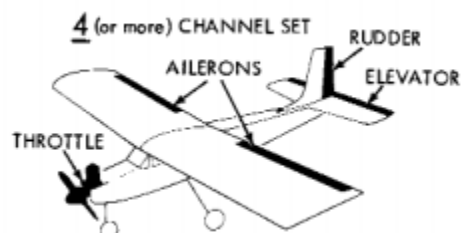
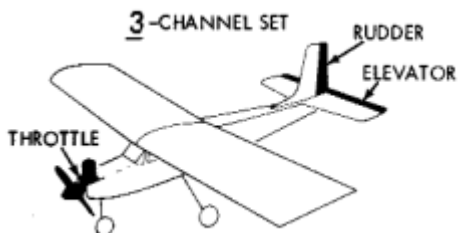

## ENGINE, PROPELLER & ACCESSORIES

Your plane flies well using any 2-cycle engine size from .35 to .45, or 4-cycle engine .45 to .61. The numbers .35 to .45 refer to the amount of space the piston moves through inside the cylinder of the engine. This space is called displacement; larger displacement generally means more power. If you live in a hot climate, or your flying field is approximately 3,000 feet or more above sea level, you should stay with a .45 engine. It's a good idea to select an engine that is popular at the flying field, so that if you have any engine problems, other modelers will be familiar with the engine and be able to help.

The propeller size must be matched to the engine. For example, a .35 may use a 9" diameter prop while a .45 can use a 10" prop. Refer to the propeller chart below for recommended propeller sizes. It's wise to buy a few spare props, as everyone breaks them occasionally, and particularly often when learning to fly.

Balancing your propeller helps to protect your radio from the damaging effects of the market. We recommend sanding the heavy blade on the curved face, out near the tip, rather than on the flat face. Try to maintain the normal airfoil curvature. Avoid scratches which may cause the prop to break. Never carve or cut a prop near the hub for any reason (such as to fit a spinner).

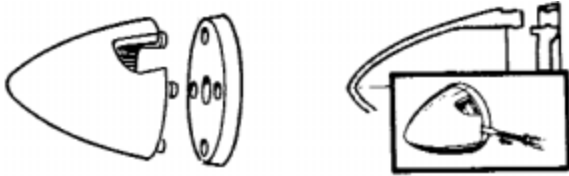

A 2 1/4" CGP Snap-On Spinner is recommended for the Eagle. It is a rugged precision molded spinner which does not require any special mounting nuts or screws. Although a spinner helps reduce the chance of injury from the rotating prop, extreme caution always must be used when the engine is running.

PROP AND FUEL TANK CHART NUMBERS IN PARENTHESIS REFER TO 4-CYCLE ENGINES		
FOR ENGINE SIZE	USE PROP SIZE	AND TANK SIZE
.29-.35 (.40-.46)	10-5, 10-6 (11-6, 12-6)	6-8 OUNCE (6)
.40-.45 (.60-.61)	10-6, 10-7, 11-6 (13-6)	8-10 OUNCE (8)

Refer to the Prop & Fuel Tank Chart shown here for the correct size fuel tank for your particular engine. There are many sizes and brands available. Assemble your fuel tank according to the manufacturer's instructions.

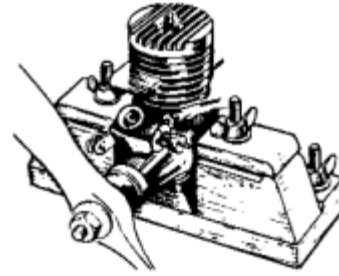

As with other precision equipment, a new engine should be "broken-in" to enhance performance and extend its life. Breaking-in usually consists of running the engine with a "rich" fuel mixture and at lower RPMs until all the moving parts get to "know each other better." This can be done with the engine mounted in the model or securely clamped into a CGM Engine Test Stand or similar device. Refer to your engine's operating manual for the recommended break-in procedure and follow it carefully.



## FIELD EQUIPMENT

The following equipment will be needed at the flying field to start your engine, make adjustments, and clean your model after flying.

**FLIGHT BOX:** Something sturdy in which to carry your equipment. CGP's SuperTote or ProTote are economical, easy to build, and pack lots of utility into little space. They hold fuel, transmitter, starter & battery, as well as many tools, in a balanced load that is easy to carry.

**STARTING BATTERY AND GLO-PLUG CLIP:** A 1-1/2 volt battery is required to heat your engine's glo-plug for starting. Wires connect the glo-plug clip to the battery. Because engine starting draws a lot of electric power from the battery, rechargeable ni-cad batteries are recommended. Although they cost more initially, they are more economical in the long run than frequently replacing dry-cell batteries.

**FUEL:** For best engine performance, use the fuel recommended by your engine's manufacturer. 2 and 4-cycle engines require different fuel blends. Ask your dealer to recommend a good quality 5-10% Nitro fuel.

**FUEL PUMP:** Needed to transfer fuel from the fuel can to the model's fuel tank. A simple squeeze-type bulb will do for small tanks, whereas manual crank or electric pumps fill larger tanks more quickly.

**FUEL LINE:** Have about 3 feet of silicone fuel line to make connections between the fuel pump, the fuel can, and the model's fuel tank.

**EXTRA PROPS:** Experts always have a few spares on hand, so flying doesn't have to stop due to a broken propeller.

# INTRODUCTION

## USING THIS INSTRUCTION MANUAL

Before you start gluing and sanding, take some time becoming familiar with the plans and looking through this entire instruction booklet. It is designed to guide you through the construction process step by step, so build in the order given in this book. Balancing, setting up and flying the model are also covered.

Like a full-size airplane, the **EAGLE II** is built from basic structures (stabilizer, fin, wing, etc.), which are then assembled into the complete airplane. Special procedures or comments will usually be explained before a step, so you will be prepared. If a step begins with a statement like "Note," "Warning," or "Important," it is a good idea to read through the step before doing it.

A check-off box appears at the beginning of each step. Check these boxes as you build, so you can tell at a glance what steps you have completed. Some steps are repeated and must be marked twice, as in the case of the left and right wing panel.

## HOW TO READ THE PLAN

There is one plan sheet in this kit, showing the Fuselage (Body), the Wing, and the Tail Parts. Everything on the plan is drawn to full-size and shape and shows how the finished parts fit together.

The plan is drawn to show the model completely assembled, but as a result, the areas inside or underneath are covered up, making it hard to understand how these parts fit together. Therefore, for clarity, some parts are drawn with hidden lines, others with breakaway views, and some are entirely removed from the structure and shown separately.

For example, on the fuselage, the left side of the completed model has been removed to show the details inside. Sometimes a surface is broken away to reveal the detail behind or underneath. Dashed lines indicate details that are hidden behind or under another part of the surface.

FUSELAGE DRAWN WITH LEFT SIDE REMOVED TO REVEAL INNER FUSELAGE DETAILS

THE WING IS SHOWN CUT THROUGH AT THE CENTER- THIS IS A "SECTION" VIEW

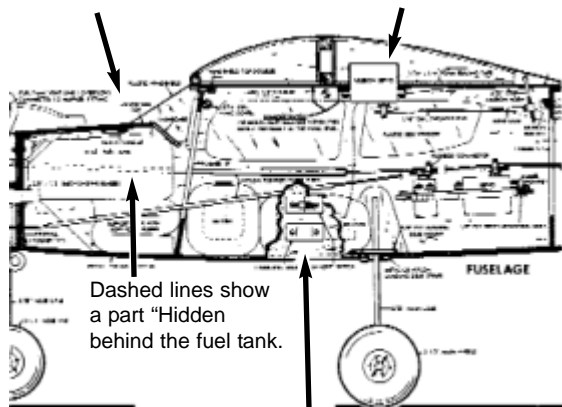

Dashed lines show a part "Hidden behind the fuel tank.

Fuselage side "Breakaway" view to show how switch is mounted

The model is made from four varieties of wood: balsa, bass, birch, and various plywoods. Each kind of wood has its own characteristic *end grain pattern* (as viewed from the end) which has been drawn on the plan. You can easily use these end grain patterns to identify what kind of wood is shown for that part, if you are in doubt.

## HOW TO USE THE PLAN

The plan is used in several ways. The wings, stabilizer, and fin are assembled directly over the plan. Each wood part is matched over its corresponding location printed on the plan and pinned in place. To prevent ruining your plan from gluing your wings, etc. to it, cover the area you are working on with waxed paper.

The paper the plan is printed on can expand or contract slightly with changes in temperature or humidity. Because of this, a preformed part such as the notched wing trailing edge may not exactly match the plan. This is no problem, as slight deviations in the outline or size will not noticeably affect flight performance.

Because the fuselage plugs together and is self-aligning, it is not built directly over the plan. As you assemble the fuselage, you will find the plan helpful in identifying parts and how things fit together.

The plan also shows the installation of a typical radio, battery and all remaining equipment and hardware needed to complete the model. By referring to the examples shown, you should be able to install your own radio, etc., even if it is not the same as what is shown on the plan.

## IDENTIFYING PARTS

Parts for the wing are bundled together; likewise, parts for the tail assembly are also grouped. Die-cut plywood and balsa sheets of common sizes are bundled together, so they are less likely to be damaged during shipping and handling. The various screws, hinges, and fittings are packaged in plastic bags.

## PREPARING FOR ASSEMBLY

Set a flat, warp-free pinning board on your work bench. Any material that accepts pins, such as insulation board, soft plywood, or dry-wall (sheet rock) will work. Important: any warps or bends in the pinning board will result in wings or tail surfaces that are also warped or bent, making your model more difficult to fly. Make sure that the pinning board is flat by laying a straight edge across it. You may be able to correct a warped board by shimming its low areas.

Position the area of the plan (such as the stabilizer) on which you are going to build over the pinning board and tape it in place so the plan lays flat and wrinkle free.

Place a sheet of waxed paper over the work area to prevent SUPER JET from sticking to your plan and ruining it.

## CONSTRUCTION TIPS

In assembling your model, the following tips will prove helpful. **IMPORTANT: ALWAYS READ A FEW STEPS AHEAD.** This will alert you to coming instructions and will help you plan accordingly.

You may find it convenient to empty all of the small parts from the hardware bags into a common container, such as a margarine tub. This will help you find items quickly.

Punch out only the die-cut (D/C) parts you need as you proceed. This will help you keep track of parts, especially the small ones.

After completing each section of the aircraft, you may want to go back and re-glue the joints, just in case some area has been missed. Be careful not to use too little glue, which will leave the model weak, or too much glue, which can make the model heavy. Properly glued joints are important to the overall strength of the model. SUPER JET™ is recommended for most parts of the assembly, although JET Epoxy may be used when more time is needed for careful placement.

## ADHESIVES

The EAGLE II was designed for fast assembly using SUPER JET™ glue, which is a specially formulated cyanoacrylate adhesive CA that can firmly glue the plywood, hardwood, and balsa used in your model.

### WARNING

Never use water THIN type CA glue for general construction of your model, especially for gluing plywood and hardwood parts. Thin CA's do not adequately bond these areas.

Although most of your construction should be done with SUPER JET™, there are times, such as when you are installing the stabilizer and fin on the fuselage and want more set-up time for careful alignment and positioning, when you may wish to use SLOW JET™. And occasionally, you may also wish to use JET EPOXY™ for added strength. Aliphatic resin glue or similar water-based glues can also be used, but they will add to the assembly time because they dry so much more slowly than SUPER JET™.

### GLUING TECHNIQUES

SUPER JET™ is strongly recommended for most building tasks because, when pressed into a very thin layer, it sets almost instantly. After the initial bond, SUPER JET™ continues to strengthen. However, because of SUPER JET's™ quick set-up, you must be careful to read instruction thoroughly, as you will have only moments for positioning of parts. Be sure to trial fit parts together before gluing.

SUPER JET™ is used in two general ways. One is to apply SUPER JET™ to one part and then press the two parts to be glued together. Or, you can position parts in contact and then run SUPER JET™ into the joint. As it seeps into the joint, it will leave a slight reinforcing filler. If you don't see a slight fillet, the CA has soaked into the wood edges and a second coat is needed.

SUPER JET™ sets up a bit slower with plywood and hardwood, so hold such parts together a little longer than you would for balsa. Corner fillets take even longer to dry because there is not a thin layer.

The tendency is for all CA glues to set slower on harder woods or when in a thick layer. Corner fillets also take a while longer to dry. To speed up such slow drying joints, use JET SET™, an accelerator for all brands of CA glue. JET SET™ bridges greater gaps, speeds up slow bonds, and provides string glue joint fillets.

Epoxy glues come in two parts which need to be mixed before using. When buying epoxy, check to see how long the glue takes to set. We recommend either JET 6 MINUTE EPOXY™ or JET 20 MINUTE EPOXY™. Disposable wood strips, cotton swabs, cheap stiff bristle brushes or acid brushed from auto stores make good applicators.

Because epoxy is so thick, it is easy to apply too much. Use sparingly, especially when assembling the fin, stabilizer, and wings. CAUTION

Some people may experience an allergic reaction when exposed to fumes from CA glue or epoxy. As with paints, thinners, and solvents, it is always important to use glues only where there is adequate ventilation to carry fumes away. A fan is recommended.

Also, special care must be taken when using CA, as it will bond skin as well as other surfaces. JET DE-SOLV™ is a CA solvent which removes hardened glue from fingers and softens glued joints for repositioning. When using CA, protective eye-wear and care in keeping the glue away from the face is highly recommended. If CA does happen to get into the eye, hold lid open and seek immediate medical attention.

## MAJOR COMPONENTS BEFORE COVERING

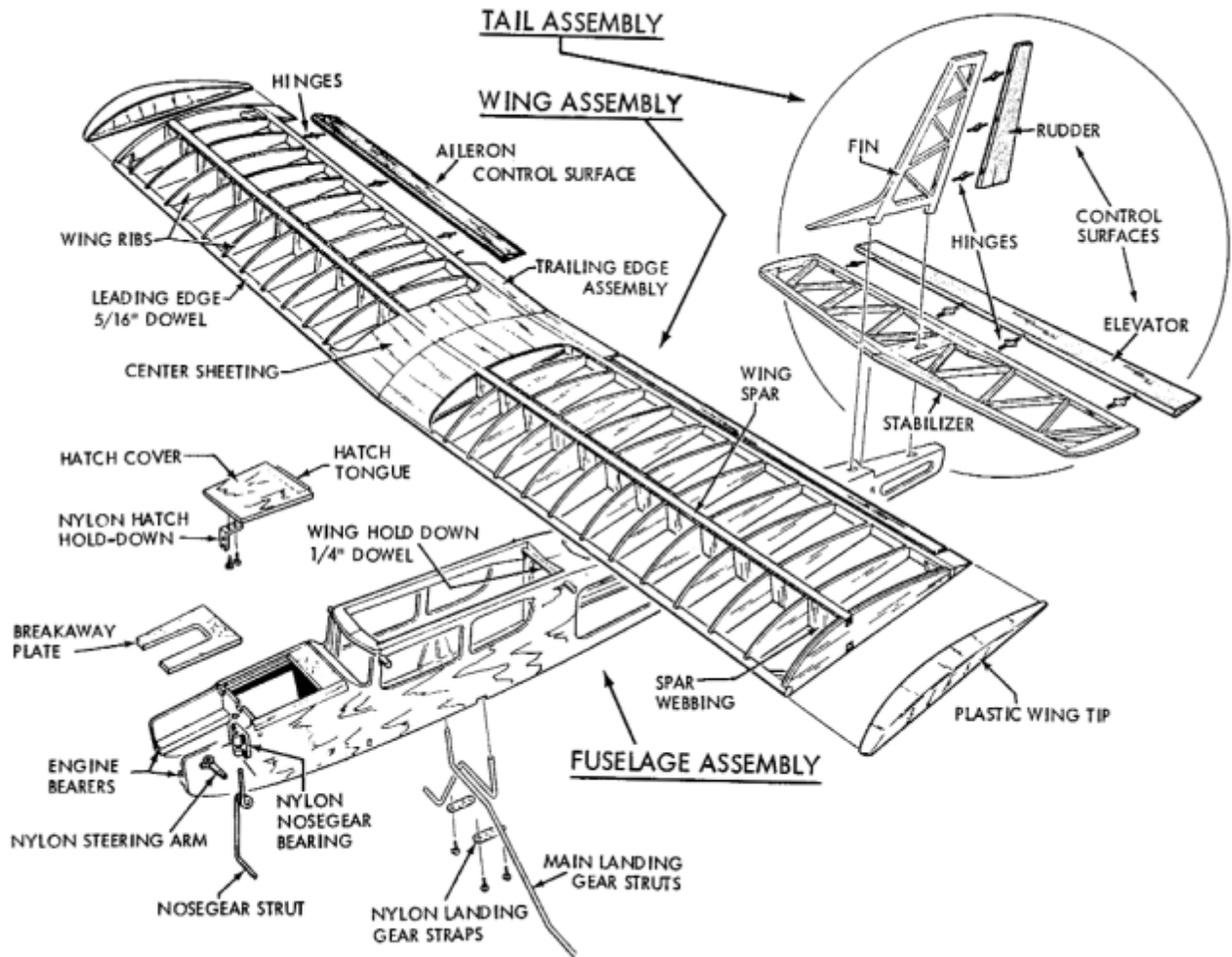

**NOTE:** In this kit version, D/C Sheets 5601, 5603, 5605, 5608 & 5609 have been replaced with D/C Sheet 5611, 5612 & 5613 (shown below)

**WOOD PARTS**

Be careful when removing parts (such as fuselage sides) from the die-cut sheets. Long parts are fragile until Super Jetted into a structural unit. If necessary, use a razor knife or razor saw to assist in the removal of parts from the sheet. Sometimes a little trimming and sanding can improve parts where desired. Save scrap until the model is completed, in case a part is missing or damaged. Also, scrap is used in some building steps.

**ABOUT THE WOOD IN THE KIT**

We strive to supply good quality materials in your kit. Wood parts are inspected with regard to the function they will serve. If an imperfection is spotted in a scrap corner of a die-cut sheet and doesn't affect actual parts; the sheet is considered acceptable. Also, internal stresses in wood are relieved as it is cut into parts. These relieved stresses may cause some parts to bow. Bows in wood parts (such as leading edges) readily straighten out as they are Super Jetted into a structural unit.

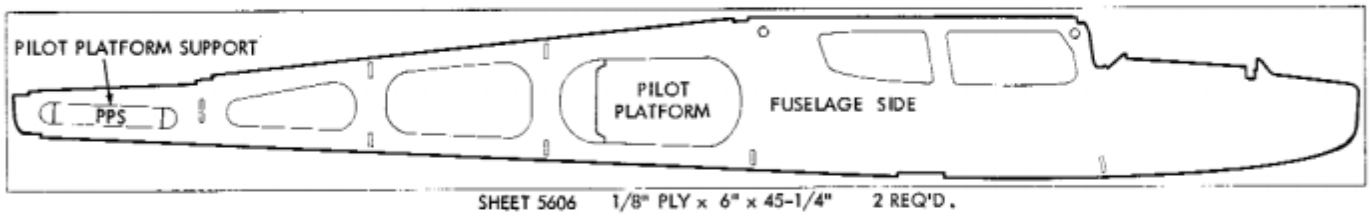
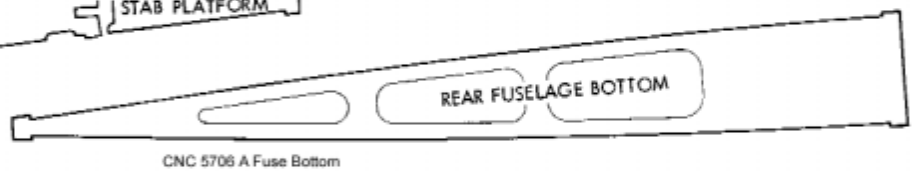
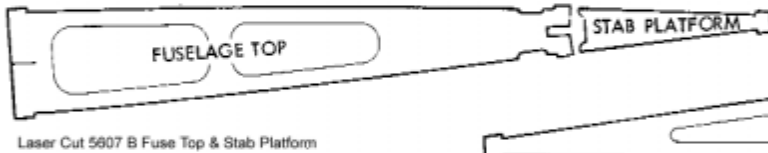
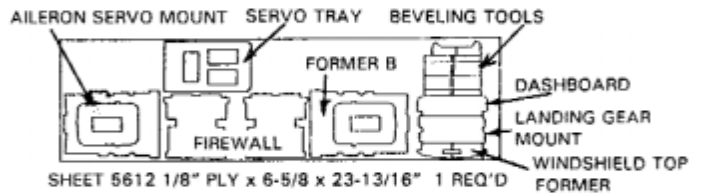
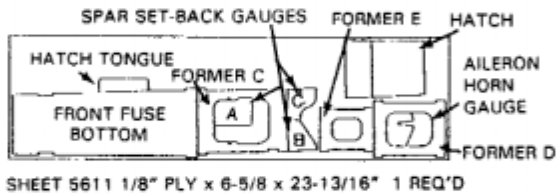
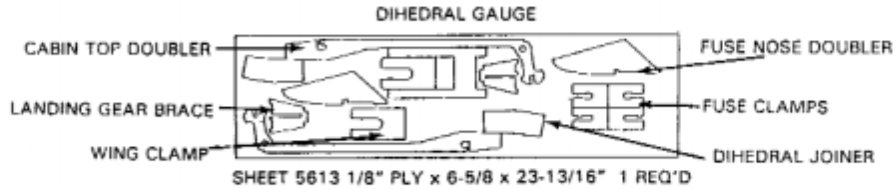
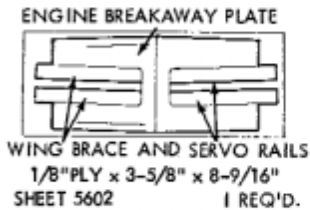
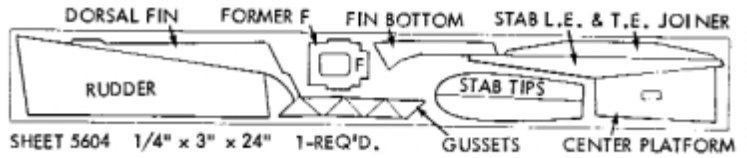
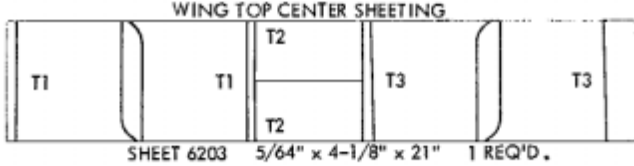
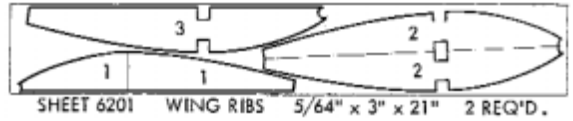
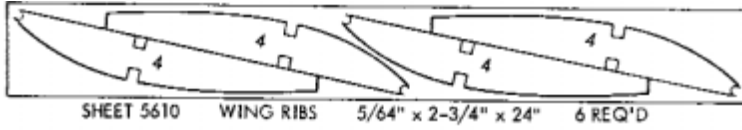

**FULL SIZE END VIEWS OF STRIP WOOD PARTS**

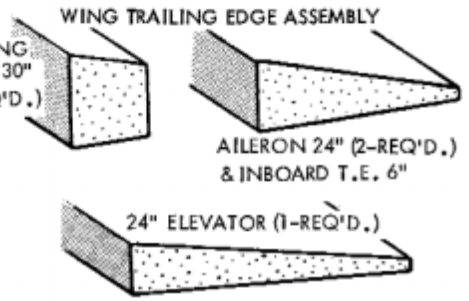
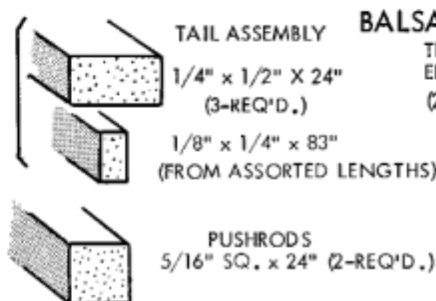
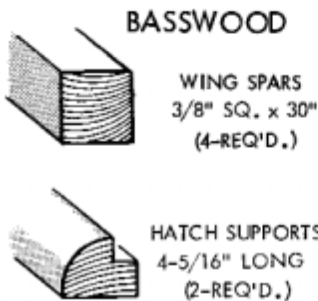

# TAIL ASSEMBLY

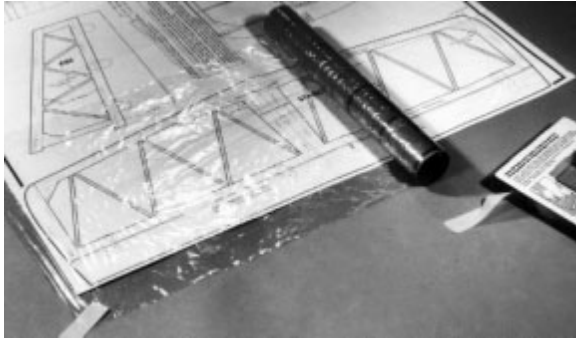

1. } Set your flat warp-free pinning board on work bench.
- } Tape Eagle plan so stabilizer (stab) is in position over pinning board.
- } Tape a sheet of wax paper or plastic kitchen wrap over stab area to prevent gluing parts to the plan as you build.

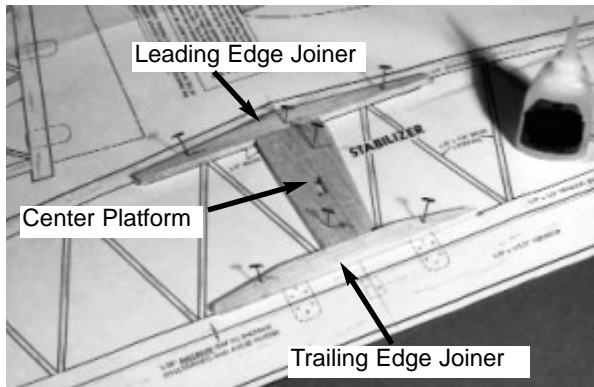

2. } Carefully position die-cut leading and trailing edge joiners and center platform and pin in place over the plan. Glue these parts together using Super Jet (Thick C.A.).

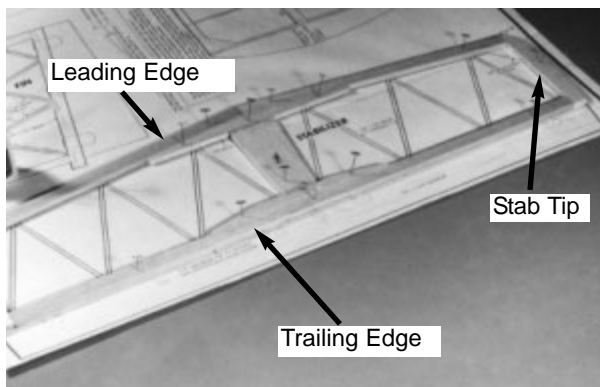

3. } Make stab leading edge (L.E.) from 1/4" x 1/2" balsa sticks. Cut balsa carefully to match with plan at center joint.
- } Pin in position and glue to L.E. Joiner.
- } Make stab T.E. from 1/4" x 1/2" balsa. Cut to match length shown on plan and glue to T.E. joiner.
- } Complete stab outline by gluing die-cut balsa stab tips in place.

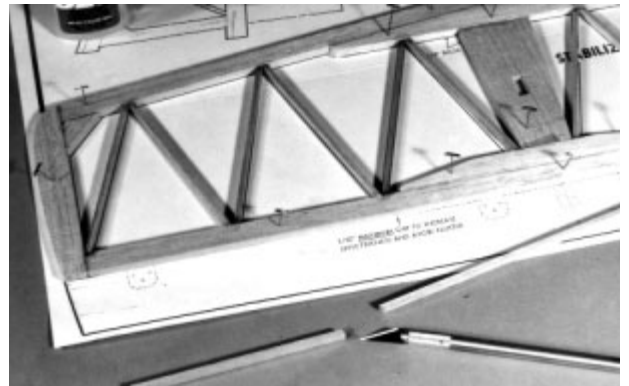

4. } From 1/8" x 1/4" strip balsa, cut all trusses to size over plan. Working one-at-a-time, trim to fit well -don't force into place. Glue in place.

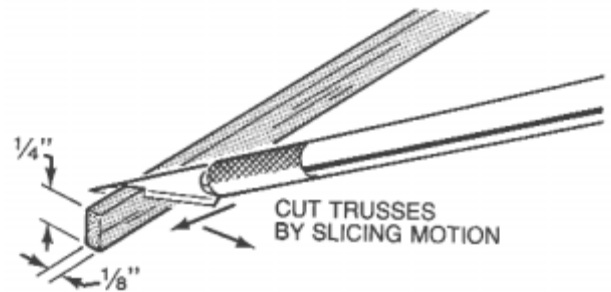

Jet set makes all brands of CA glue dry faster. Use Jet Set on corner joints for extra-strong fillets.

- } Glue gussets in place.
- } Let dry thoroughly.



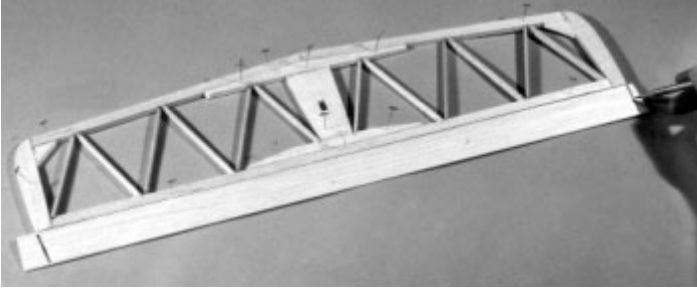

5. | Position balsa elevator against stab T.E. and mark elevator ends for match with stab tips.

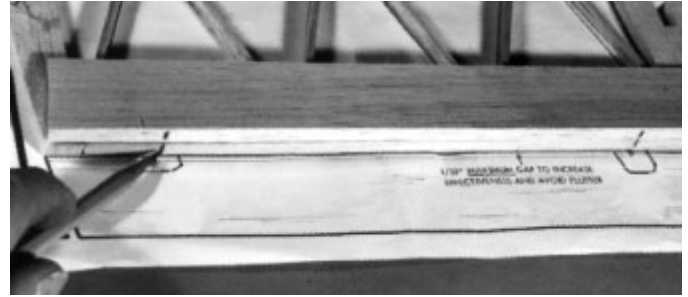

6. | Place elevator on top of T.E. and transfer hinge locations to elevator.
7. | Assemble the fin in the same manner as stab. Let dry.

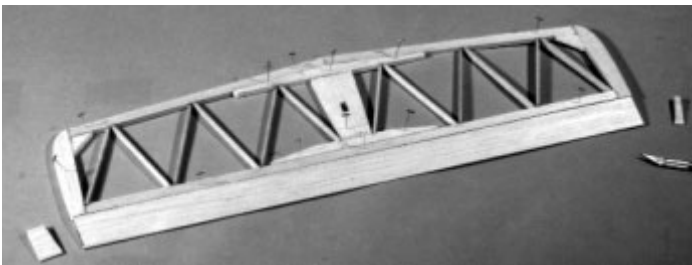

8. | Cut elevator at marks to match stabilizer tips.

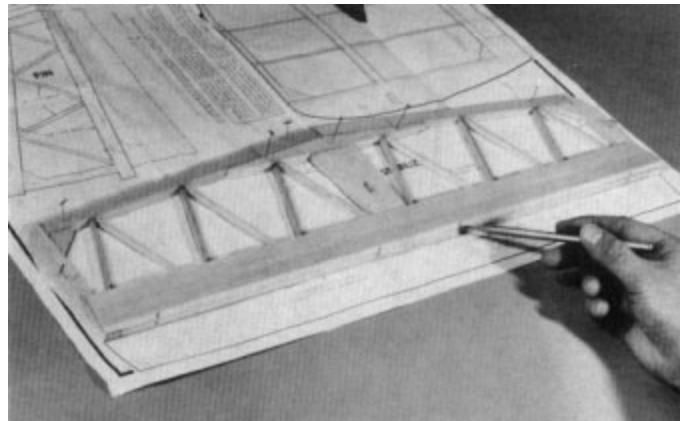

9. | Mark hinge locations on fin and rudder.

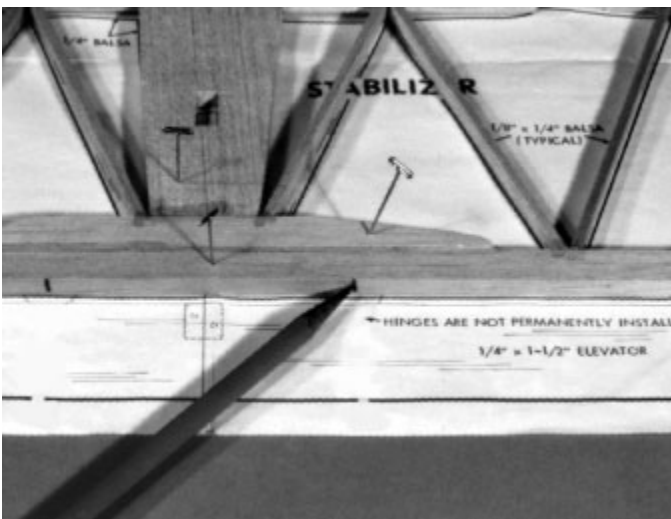

10. | Transfer hinge locations from plan to T.E.



11. | Using the CG Center-Line Marker provided, mark center lines along edges of parts as shown. Tilt marker so guide pegs touch the wood, then lightly pass the marker back and forth. Point will scribe center line.

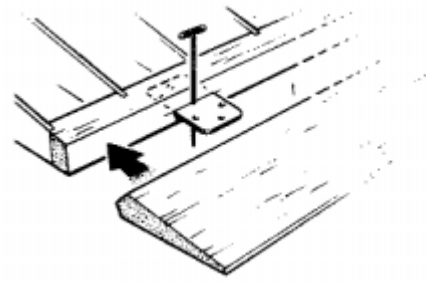
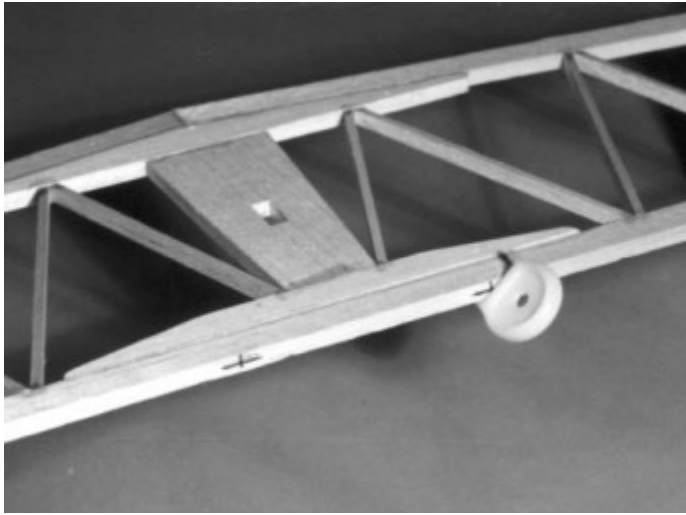

- 1 Use your CG Hinge Marker to mark the center of the wood surfaces to be joined.
- 1 Carefully cut a slot approximately 1/2" deep and slightly wider than the hinge, using your favorite knife blade.
- 1 After all slots have been made, mark the center of your hinge and insert a pin (see illus.) This will hold the hinge in place while sliding the matching part (aileron, etc.) onto the JET HINGE.  
**DO NOT GLUE!**
- 1 With both surfaces hinged and assembled, check the alignment. For good control response, the hinge gap should be as small as possible, but should allow for full deflection when needed.
- 1 Remove the hinges and complete the construction of the airplane.

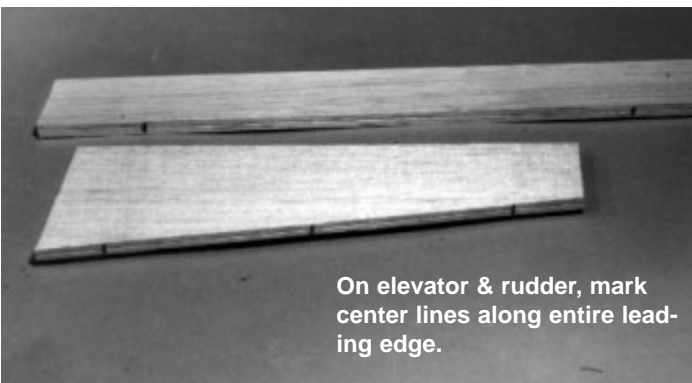
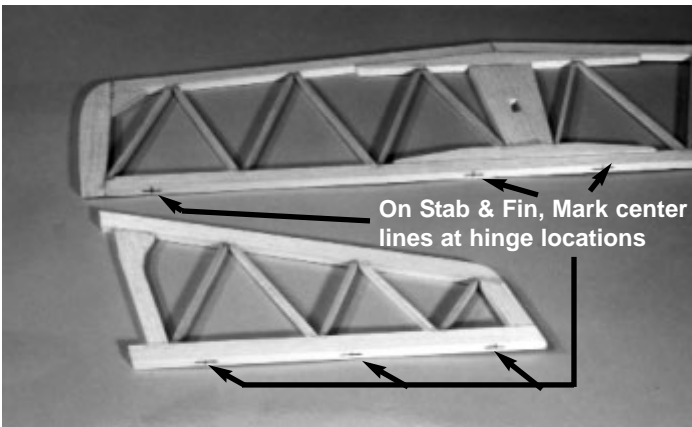

Note: in the next few steps the hinges will be TEMPORARILY installed - they are not permanently installed until after the model is covered.

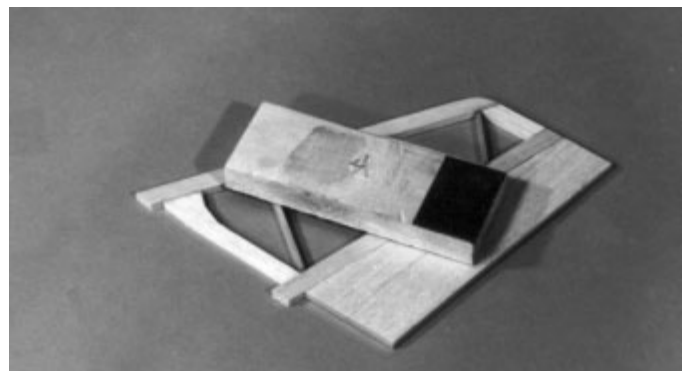

- 1 Flat sand fin and stab, round outer edges (except bottom & lower 2" of fin L.E. Sand elevator tips to blend with stab.

## ASSEMBLING DIE-CUT BEVELING TOOLS (FROM 1/8" PLY)

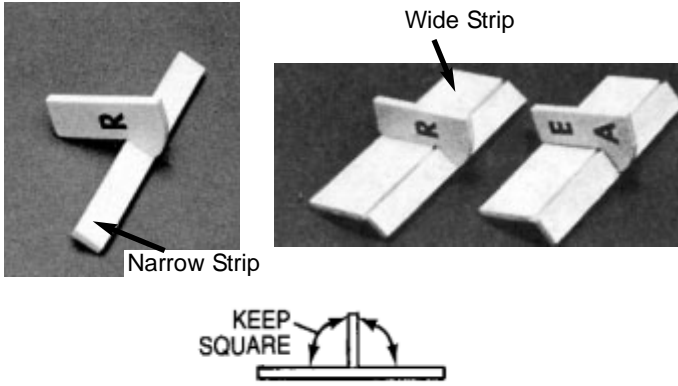

14a. First glue narrow strip to handle, keeping them square, as shown. Then glue wide strip to handle and narrow strip, again keeping things square.

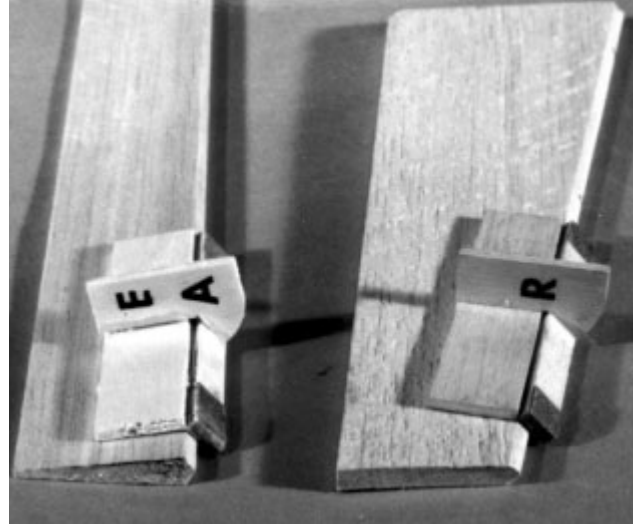

15. Tape T.E. of elevator and rudder to work surface. Using appropriate beveling tool, sand LE. to center line. Turn parts over and repeat beveling for other side.

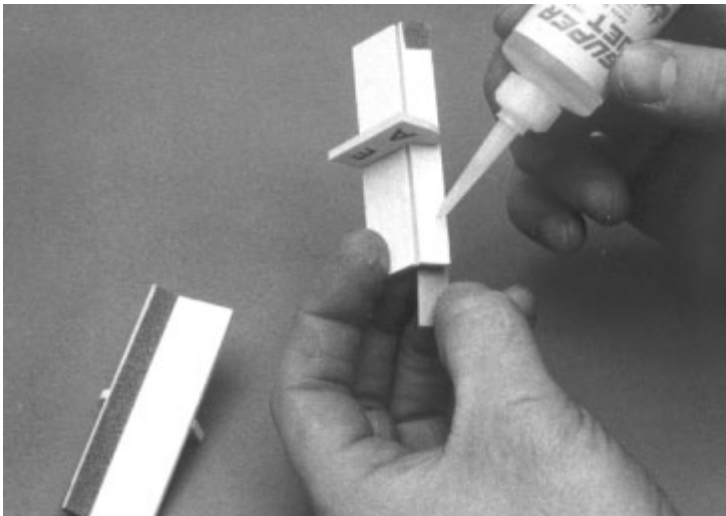
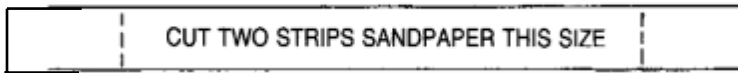

14b. Cut two strips of 100-200 grit sandpaper to size shown above. Tack-cement sandpaper to tools.

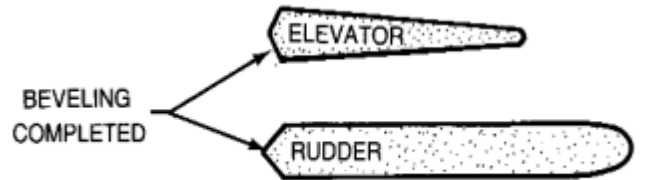
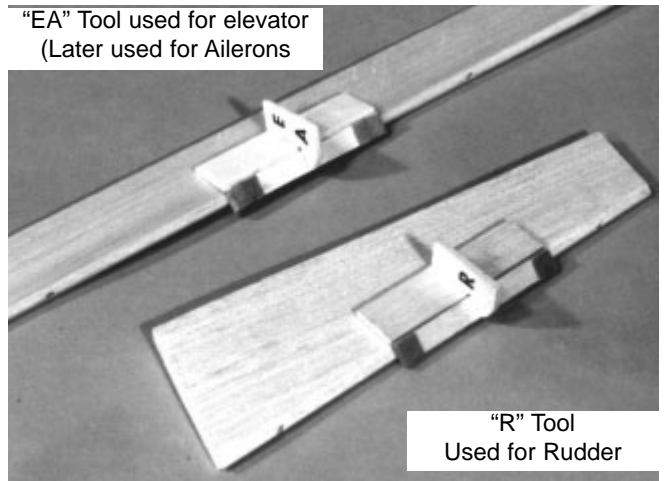

THIS COMPLETES THE TAIL ASSEMBLY CONSTRUCTION.

# WING ASSEMBLY

**IMPORTANT! READ THIS BEFORE STARTING ASSEMBLY YOUR EAGLE'S WING CAN BE BUILT TWO WAYS**

Select The Wing That Fits Your Radio and Flying Requirements.

## "A" or "B" WING

For 4-CHANNEL FLYING

"A" WING — Aileron Wing for Sport & Training  
 "B" WING - More Aerobatic Aileron Wing

## "C" WING

For 3-CHANNEL FLYING

High Dihedral Wing for Control Without Ailerons

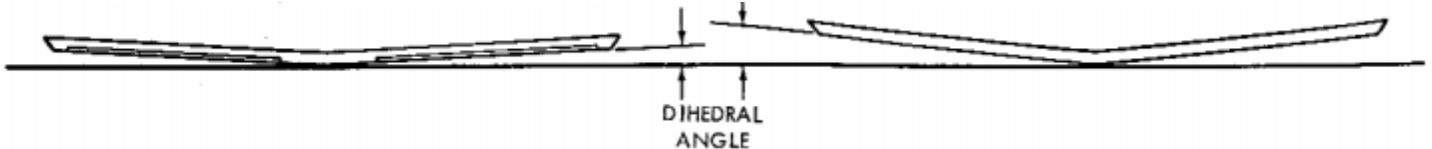

The Ailerons, the movable control surfaces at the trailing edge of the "A" or "B" wing; allow more precise control of maneuvers. The "A" wing has average dihedral (the upward bend of the wings), and is quite stable and maneuverable. The "B" wing has very little dihedral (it is almost flat), which decreases stability slightly, but increases stunting ability. It is recommended for experienced flyers only! Ailerons require 4 (or more) channel equipment, and more work in the wing construction.

Because the "C" wing has greater dihedral angle, it inherently is more resistant to banking, and more responsive to being turned. The model is turned by the rudder, which then reacts against the dihedral. The "C" wing is recommended for 3-channel equipment, or if you want to keep things simple, or for learning to fly without an instructor.

To build either the "A", "B", or "C" wing, simply proceed with the following instructions.

After you have finished gluing the wing together, go back and re-glue all the joints for added strength and just in case some joints may have been missed the first time.

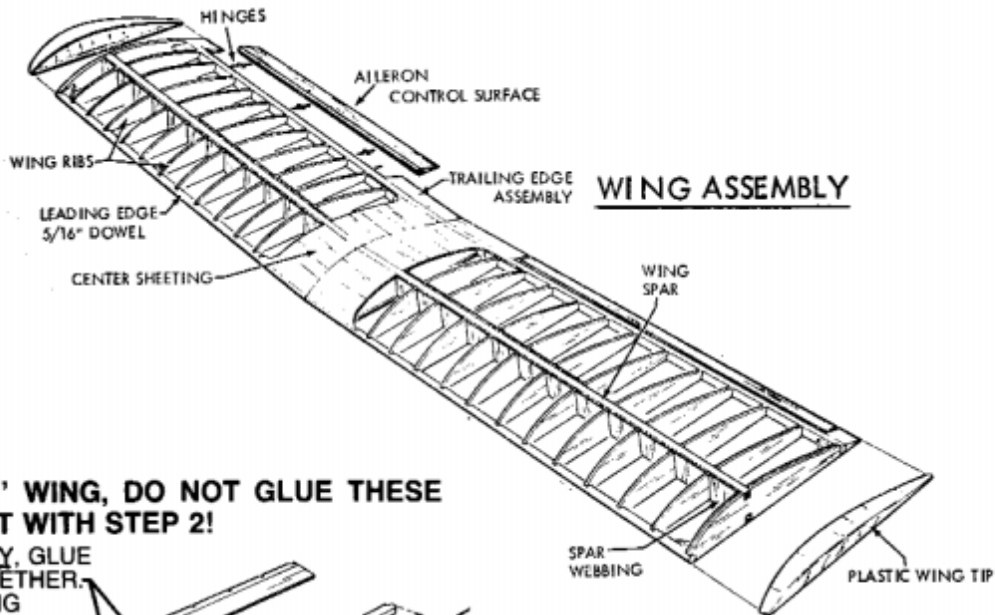

**FOR "A" or "B" WING, DO NOT GLUE THESE PARTS — START WITH STEP 2!**

**FOR "C" WING ONLY, GLUE THESE PARTS TOGETHER. MAKE TWO TRAILING EDGE ASSEMBLIES.**

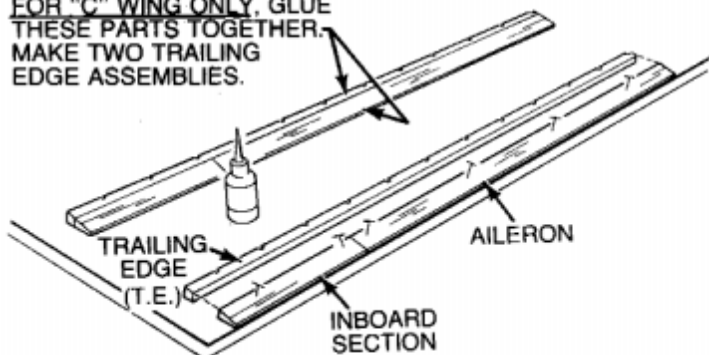

1. THIS STEP FOR "C" WING ONLY (for "A" or "B" wing start with Step 2). Align aileron and inboard section along any straight line on plan and pin in place. Glue them together. Glue trailing edge (T.E.) to aileron & inboard section. Note; from Step 4 on in the wing assembly photos & sketches, the "A"- "B" wing is shown (ailerons not glued to T.E.) but the wing assembly procedure is the same for the "C" wing.

SINCE THE WING IS BUILT IN TWO HALVES, AND STEPS 2 TO 14 ARE REPEATED IN THE PROCESS, TWO CHECK BOXES ARE PROVIDED WITH EACH OF THESE STEPS, ONE FOR THE RIGHT WING HALF AND ONE FOR THE LEFT HALF. THE RIGHT WING HALF IS BUILT FIRST.

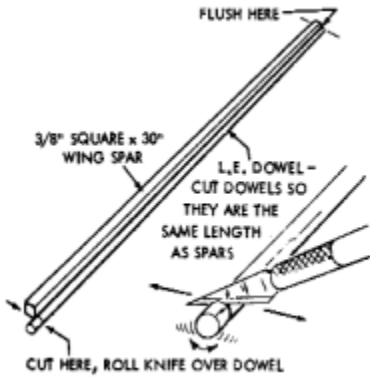

2a. } } IMPORTANT! Compare the leading edge dowels to a wing spar. If dowels are longer than spar, cut dowels to match spar.

**IMPORTANT!**  
BUILD ONE RIGHT WING  
AND ONE LEFT WING

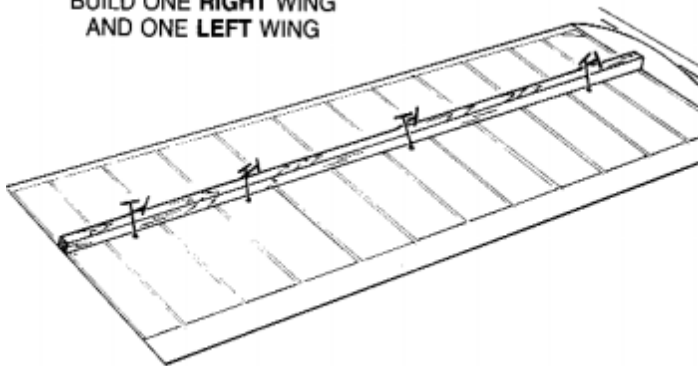

**DO NOT BUILD TWO RIGHT WINGS!**

2b. } } Position one spar in place over RIGHT WING (or LEFT WING) on plan. Align spar end at center of wing on plan. Hold spar in exact position by crosspinning at circled locations on plan. CAUTION; Do not build two RIGHT WINGS!

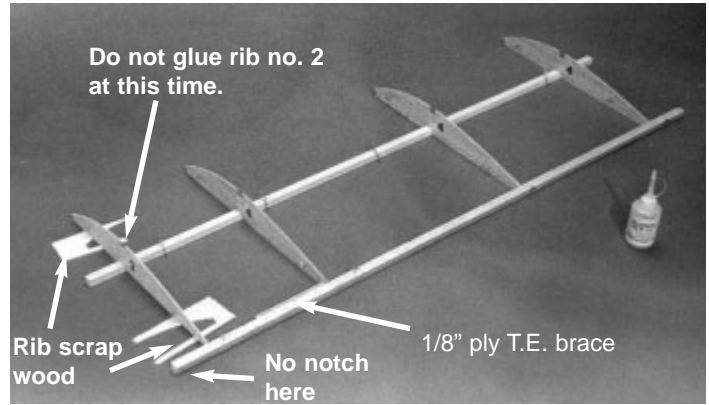

3. } } Using no pins, set TRAILING EDGE (T.E.) in place on plan. IMPORTANT: The T.E. has no notch at one end — this unnotched end must be at the wing center as shown.
- } } Using no glue, place the following four ribs in their respective T.E. notches: ribs Nos. 2, 4, 4, & 4, hooking them over the spar as you go. Place rib wood scrap under rib 2 as a shim.
- } } Align T.E. and ribs over plan, and pin in place, (Note: if a part appears not to "fit" the plan exactly, don't worry; this is due to expansion and shrinkage of the plan paper).
- } } Do not glue rib No. 2 at this time. Glue ribs No.4 to T.E. and spar.
- } } Glue 1/8" x 7/16" x 3-9/16" ply T.E. brace to T.E. as shown. Note: four 3-9/16" pieces are provided; two are T.E braces & the other two are later used as servo mounting rails.

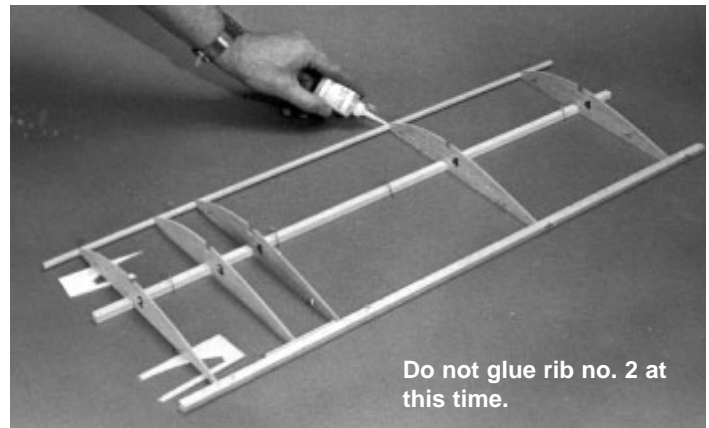

4. } } Position rib 3 in place over plan, and glue it to T.E. brace and spar.



- } } Position 30" LEADING EDGE (L.E.) dowel in place over plan. Press L.E. into rib recesses, holding it tight with angled pins as you go.
- } } Do not glue Rib No. 2 at this time. Glue rib 3 and ribs No. 4 to L.E.

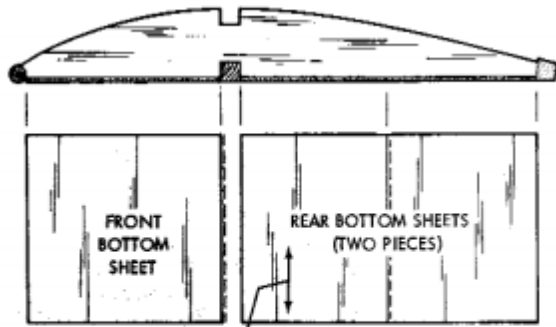

NOTE WOOD GRAIN DIRECTION IS THE SAME IN ALL THREE SHEETS.  
 IMPORTANT: BOTTOM SHEETS ARE PRE-CUT TO FIT AS SHOWN ABOVE-  
 BE SURE TO POSITION THEM CORRECTLY AS DESCRIBED IN STEPS 5, 6 & 7.

NOTE: Front bottom sheet and rear bottom sheet are found in the wood parts bag.

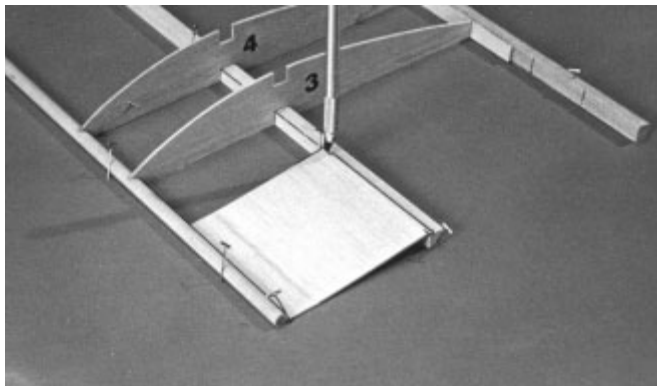

5.
  - 1 1 Pin end of L.E. and spar in place as shown . Remove rib No. 2 and scrap shims.
  - 1 1 Slide front bottom sheet forward until it just touches the L.E, and align it with end of L.E. (Note wood grain direction). Gently hold sheet in position and mark spar location on both rear corners of sheet with your knife.
  - 1 1 Remove sheet from wing, and using metal straight edge, cut a One across sheet at spar "marks." Replace sheet in wing, trim slightly if required until it fits well.

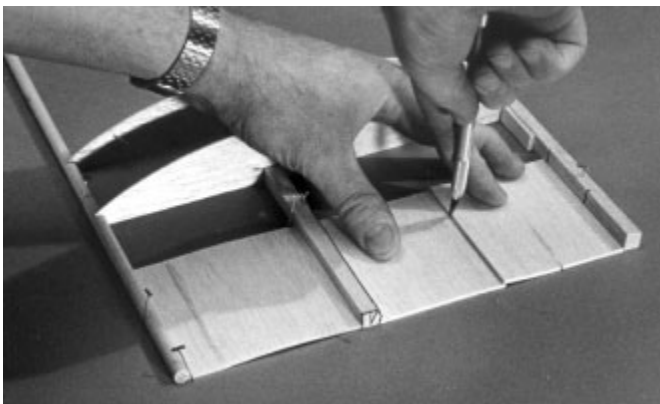

6.
  - 1 1 Position one rear bottom sheet at rear of spar. Place other rear bottom sheet at T.E, so it overlaps the first one. Holding both sheets in place, trim first sheet even with edge of second sheet.

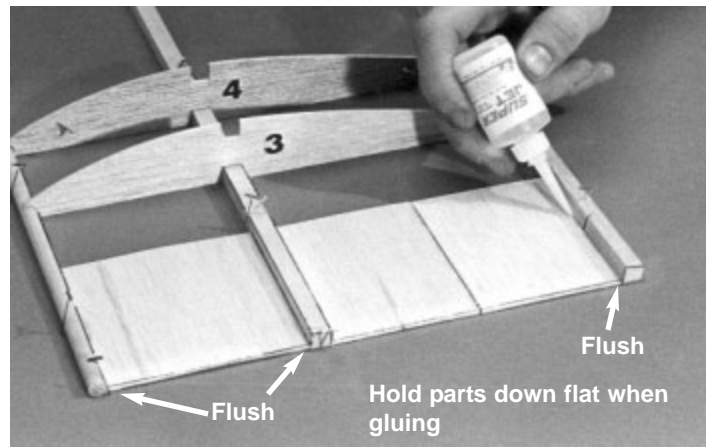

7.
  - 1 1 Glue L.E. sheeting to L.E. and spar.
  - 1 1 Glue two rear sheeting halves together, and to spar and T.E.

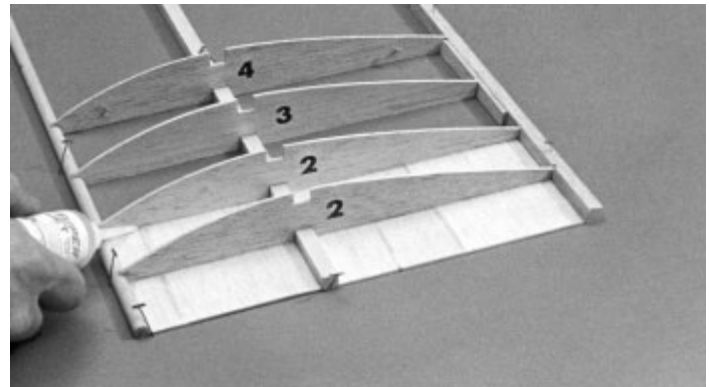

8.
  - 1 1 Position and glue two ribs No. 2 to L.E., bottom sheeting, spar and T.E. (align rib fronts over guide lines on plan).

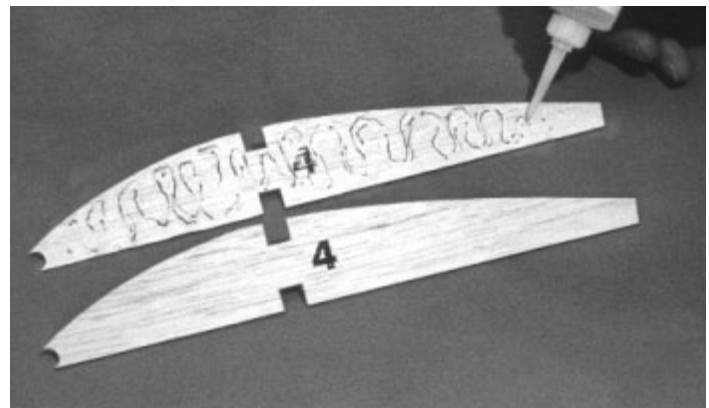

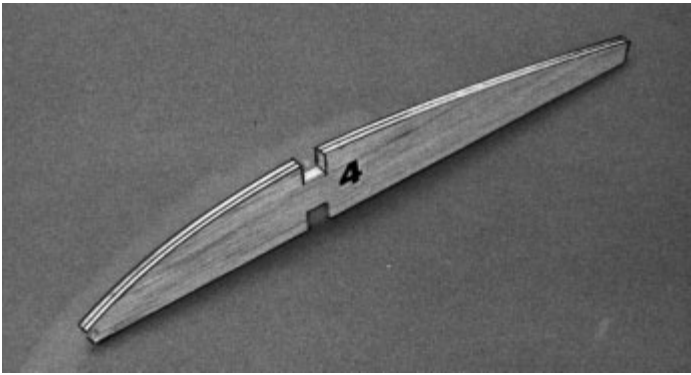

9. } } A doubled rib is necessary at the wing tip so that when you cover the wing, the tip rib won't bend. Glue two No. 4 ribs together: apply SUPER JET to one rib, stand them next to each other to check alignment, then press together.

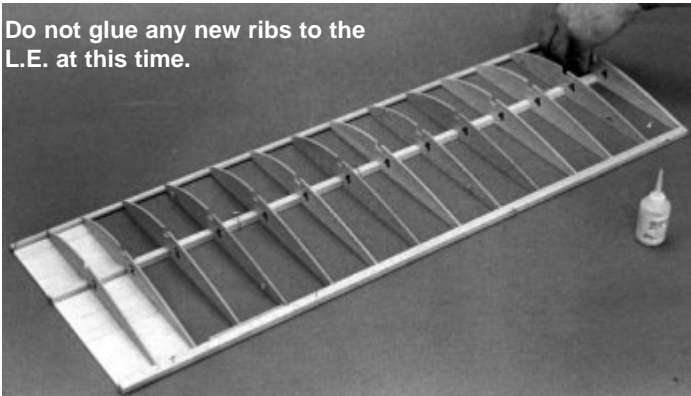

Do not glue any new ribs to the L.E. at this time.

10. } } Glue double thickness rib No. 4 in place at wing tip, gluing to spar and T.E. only. Hold rib straight up until it sets.

- } } Working one at a time, glue remaining ribs No. 4 to spar & T.E. only. Hold each rib up straight as it dries.

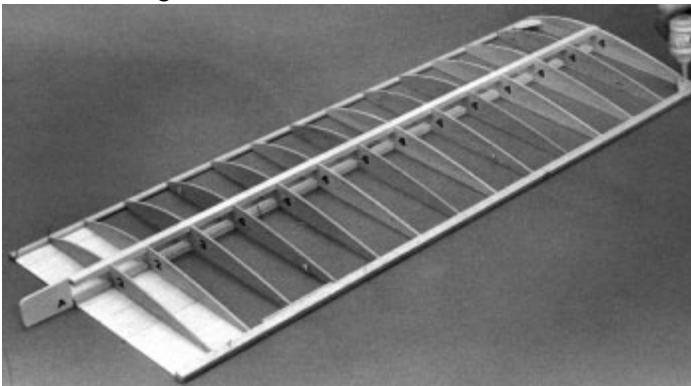

11. } } Three set-back gauges are supplied, one for "A", one for "B", and one for "C" wing. Position proper gauge touching bottom spar. Touch end of top spar to gauge, and set spar in rib slots.

- } } Glue top spar to all ribs.

- } } Glue wing tip gussets to L.E. and T.E.

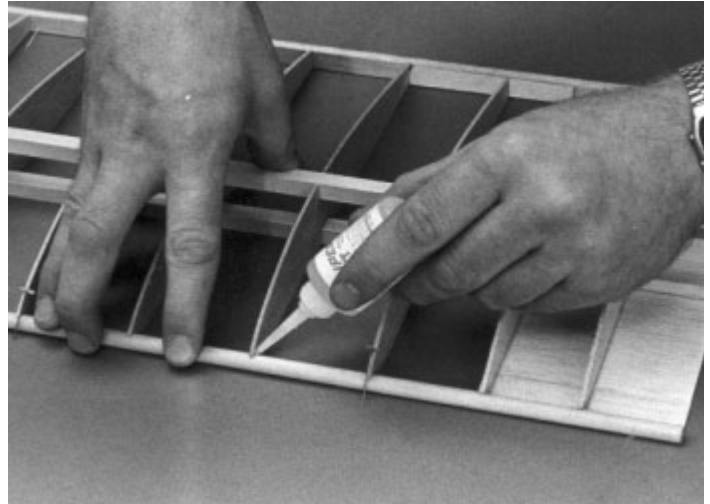
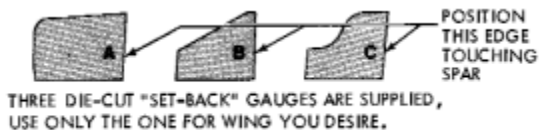

12. } } Working a few ribs at a time, apply SUPER JET to glue loose ribs to L.E. Gently squeeze LE. into ribs and hold until set. Repeat until all ribs are glued to L.E.

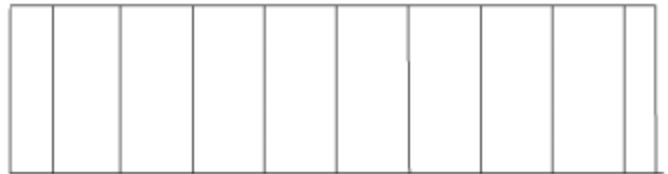

Laser cut sheet 5600

13. } } The shear webs to be installed in the next step are located on die cut sheet #5600.

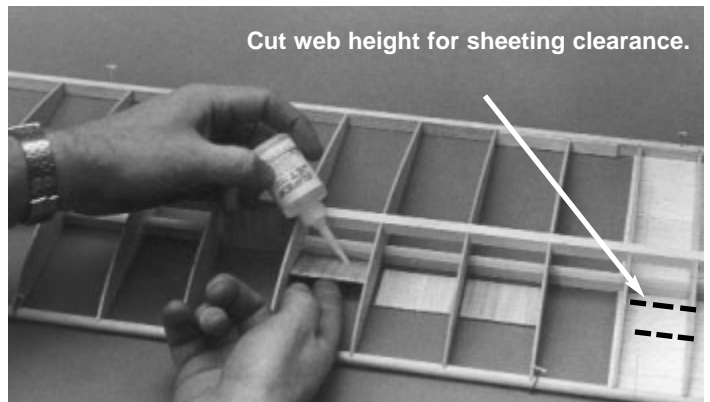

Cut web height for sheeting clearance.

- 13a. } } Install pre-cut webs in wing at positions shown on the plan as follows: Apply two beads of glue (along top and bottom), then press web up in place against spars until set.



WEBS MUST BE INSTALLED BETWEEN ALL RIBS  
REFER TO PLAN FOR ALL WEB LOCATIONS.

- 13b. | Continue gluing webs to spars at locations shown on plan; cut 1/4" off webs next to center sheeting.
- 14. | Repeat steps 2 through 13 for LEFT wing.

**READ THIS STEP THOROUGHLY BEFORE GLUING!**

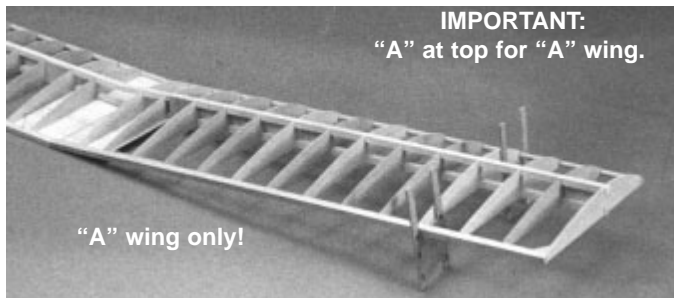

SUPPORT WING AT 4th RIB IN FROM TIP

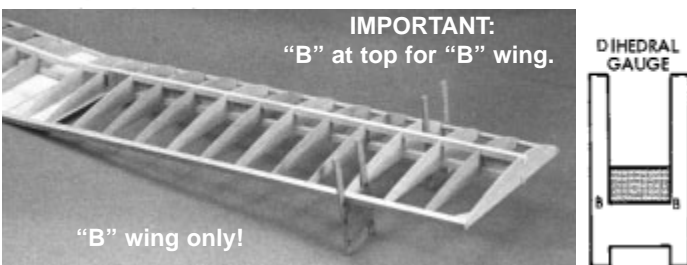
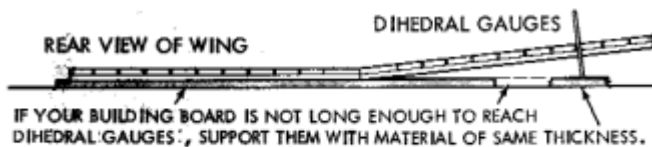

SUPPORT WING AT 4th RIB IN FROM TIP

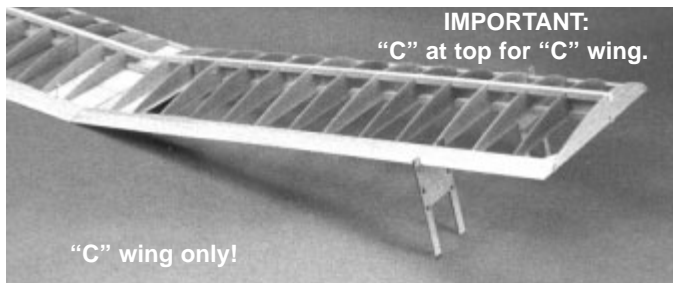

SUPPORT WING AT 4th RIB IN FROM TIP

- 15. | With left wing still pinned down, position RIGHT WING in place next to it. Raise RIGHT WING tip and support it at 4th rib in from tip using diedral gauges. NOTE: gauge ends are stamped, "A," "B" and "C."
- | For "A" wing, gauge end "A" must be up.
- | For "B" wing, remove shaded area of gauge (as shown at left).
- | For "C" wing, gauge end "C" must be up.

Hold gauges firmly to the ribs by tack-cementing or stationary clamps, clothespins, etc.

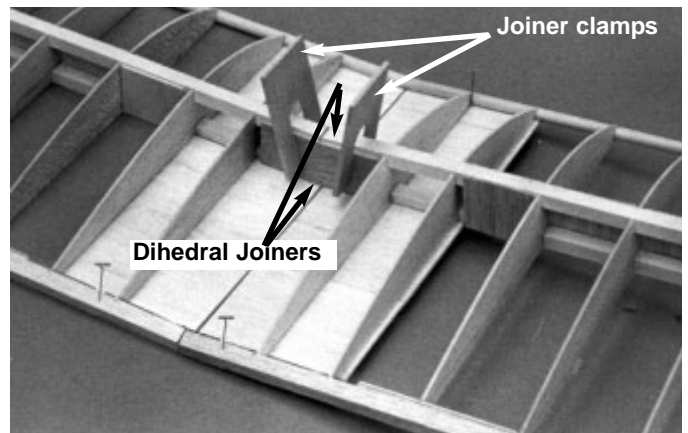

- 16. | Study entire center joint; all end parts of right wing should just touch those of the left (tiny gaps are alright). If the fit between most parts is a little loose because one part protrudes too much: slightly sand only the protruding part for better fit. When sanding, it is better to take off too little than too much!
- | TEMPORARILY set diedral joiners in place on each side of spars, using die-cut clamps provided to hold joiners tight against spars.
- | Be sure RIGHT WING is held firmly against LEFT WING and pin in place as shown above. Remove joiners.

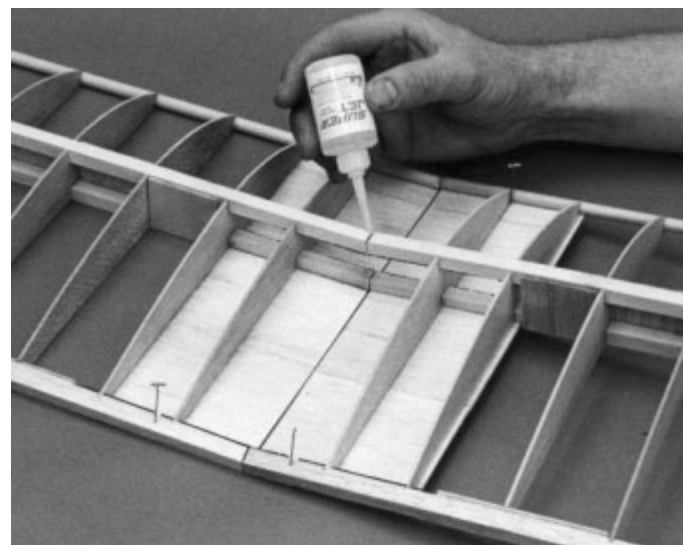

- 17. | Apply a liberal bead of SUPER JET to joints of L.E. spars, sheeting, and T.E.



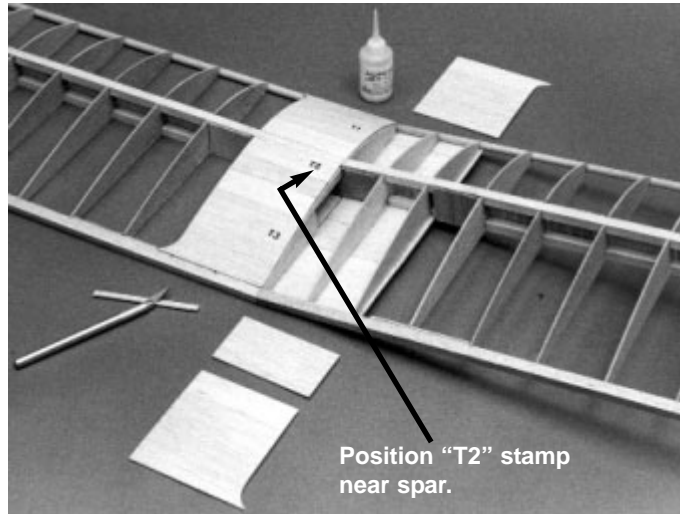
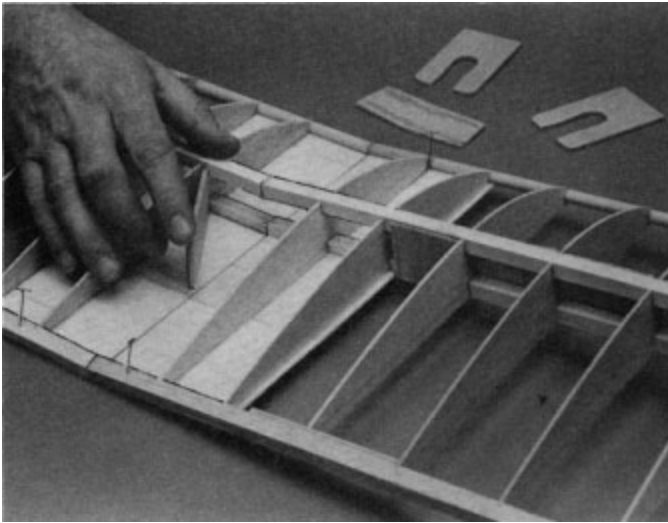

18. } Apply two ribbons of SUPER JET to one side of both joiners, near the top and bottom, Position one end of joiner in place and swing the other end up against spars — hold momentarily. Repeat for other joiner — immediately reinstall clamps (from step 16) to hold both joiners tight on spars.

20. } Remove all clamps, etc.
  - } Try top sheeting in place, trimming to fit as required. Match edge of sheeting with center of rib No. 1. Glue in place.
  - } Turn wing upside down and glue any joints still needing glue. For "C" wing only, proceed directly to step 34a.

**\* IMPORTANT ! \***  
**SEE BOLT-ON WING OPTION**

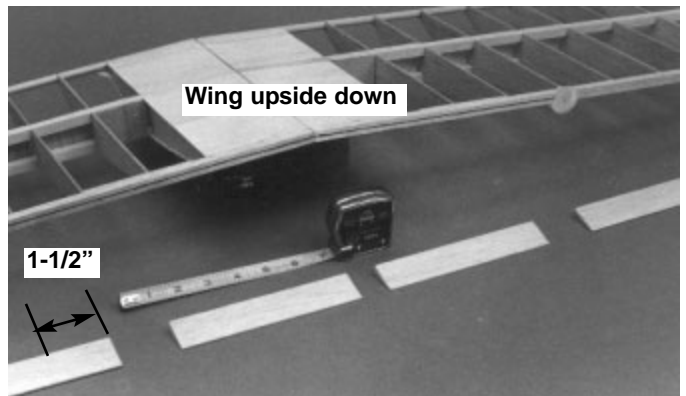
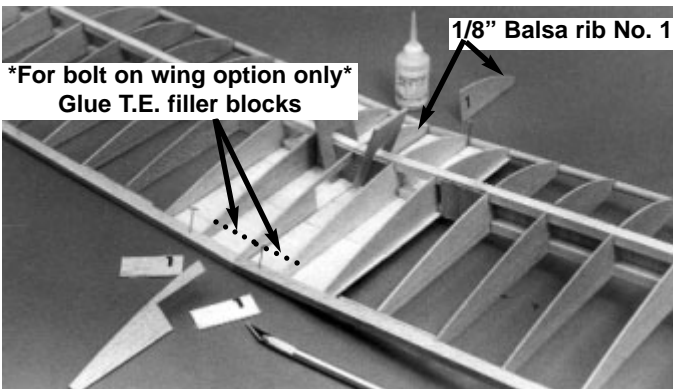

19. } For "A" or "B" wing, cut opening in rib No. 1 for your servo at stamped line on rib.
  - } Position front and rear halves of one rib No. 1 so one side aligns with centerline of wing. Adjust rib to align with spar center joint, T.E., bottom sheeting, and L..E. joints. Glue in place.
  - } Glue remaining halves of second No. 1 rib to first rib, making double thickness center rib at center joint.
  - } Be sure to glue any joints in the wing still needing glue.

21. } Using Center Line Marker, make a center line along entire lengths of T.E., inboard section, and ailerons.
  - } Mark front of ailerons 1 -1/4" from inner ends.

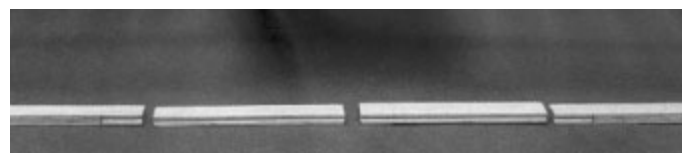

**Ailerons & inboard sections shown reversed**

22. } Make a clearance groove 1-1/4" long at the inner end of the ailerons. The groove must be deep enough so that the aileron wire will lie recessed in the aileron.

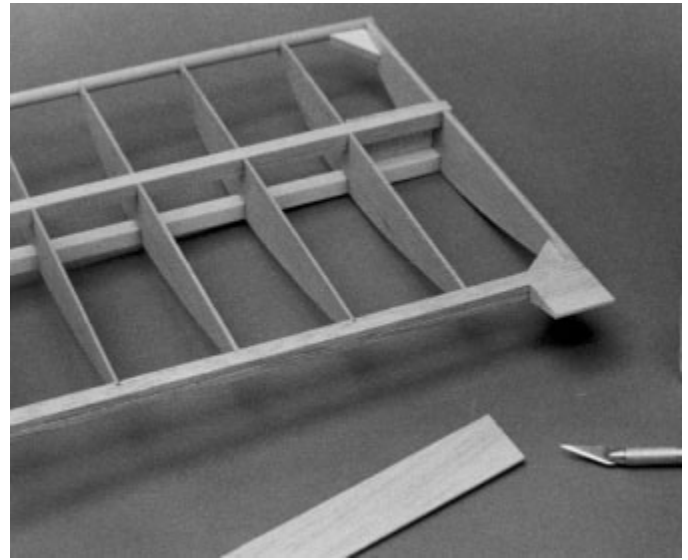
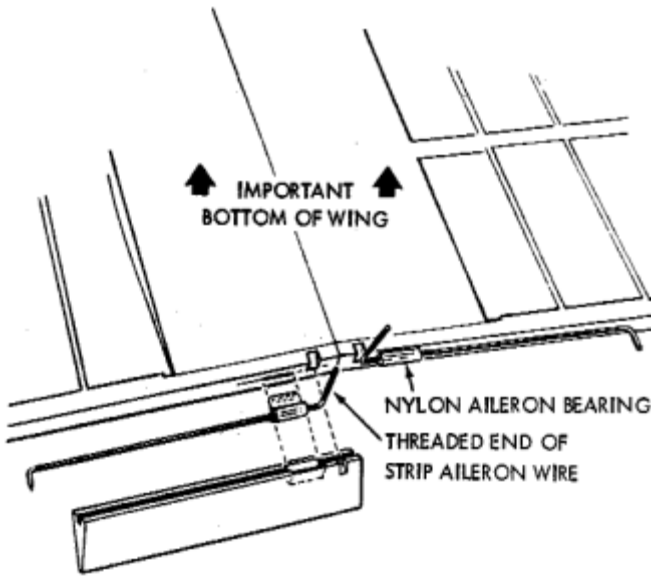

- 23a.1 Place wing over plan and mark T.E. for nylon aileron bearing locations. Using a razor knife, cut slot through T.E. center-line for each bearing glue tab.

**IMPORTANT: IN THE NEXT STEPS THE WING MUST BE TURNED BOTTOM SIDE UP.**

- 1 Cut a clearance slot 1/2" from center joint in wing T.E. and 1/2" from inner ends of T.E. inboard sections. These are clearance slots for the strip aileron wires—they allow the threaded end ("horn") of the wire to rotate forward and back.

24. 1 Cut 1-1/4" off wing tip end of ailerons, and glue to T.E. flush with end of T.E. as shown above.

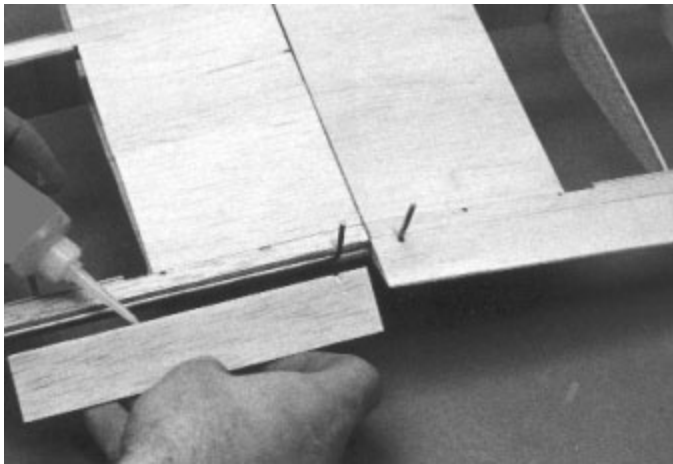
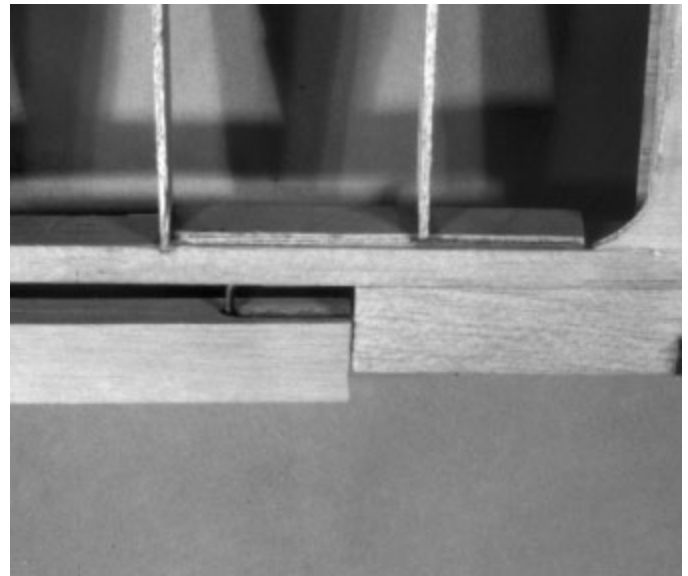

- 23b.1 Using NO GLUE AT FIRST, temporarily slide bearing tabs in wing slots and position both T.E. inboard sections over aileron wires. Check for "horn" movement—top to move about 3/4" total fore and aft.

- 1 Remove TE. inboard sections and glue bearing tabs into wing.  
1 Carefully glue TE. inboard sections in place (CAUTION: Keep glue off wires).

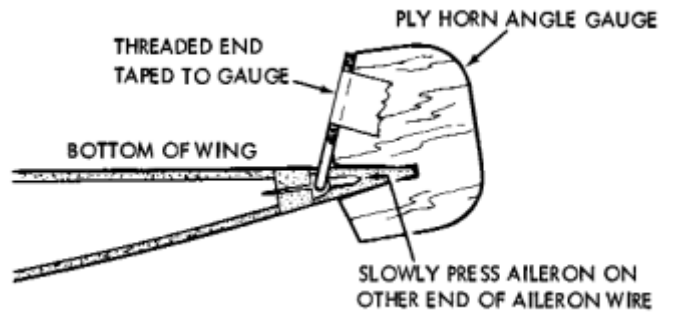

- 1 Position ply horn angle gauge at threaded end of horn wire, slowly press aileron on other (3/8" long) end of wire to make a mark. With a small nail, make a hole for the wire. Work carefully, keeping hole centered inside aileron. Repeat for other aileron.



- 1 So ailerons don't fit tight after everything gets covered, gently sand both ends of aileron. The clearance is correct when you can fit each aileron in place with a piece of matchbook cover (about 1/32") at both ends.



- 1 Place TE. on plan and mark hinge locations (three hinges per wing half).

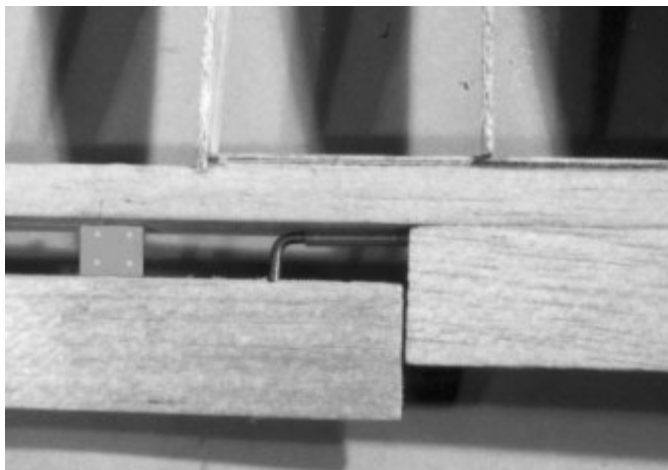

- 26. 1 Temporarily fit ailerons in wing with hinges, checking for hinge alignment.

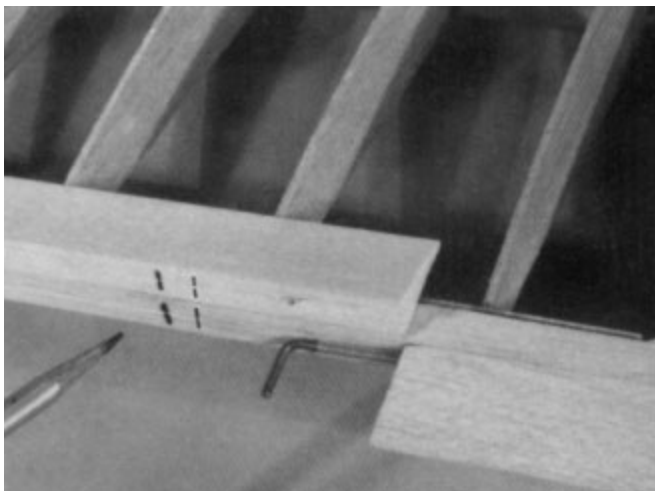

- 1 Transfer hinge locations to ailerons.

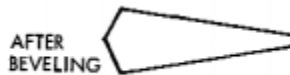
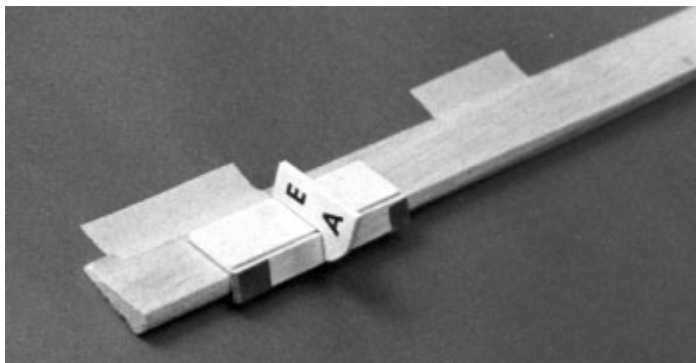

- 27. 1 Using beveling tool "EA", bevel front edge of aileron to centerline. Turn aileron over and repeat sanding. Repeat for other aileron.

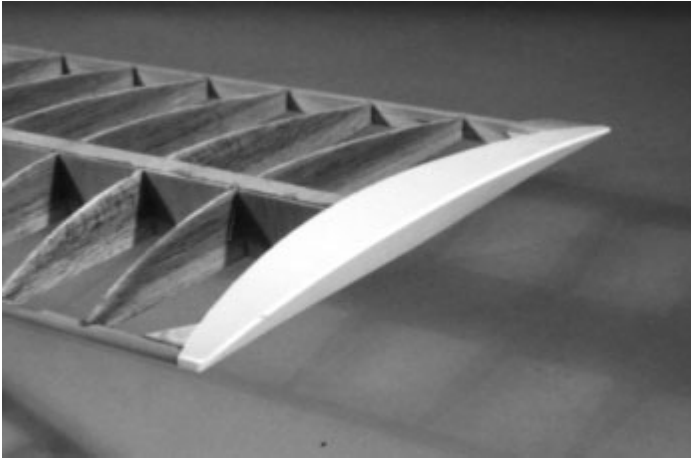

28. | Lightly sand plastic wing tips to remove burrs from pre-cut edges. TEMPORARILY fit tips in place (they are permanently installed after wing is covered as shown on page 39). If they bind at T.E., try gently forcing them on, or sand a slight recess for them in T.E.

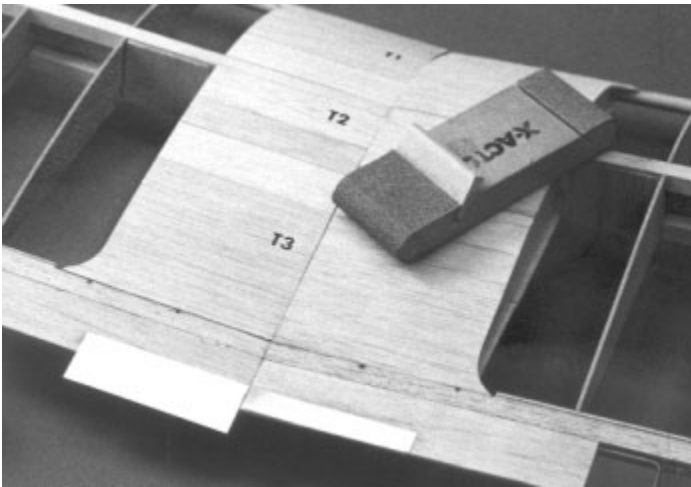

29. | Using 240 grit (fine) sandpaper, flat sand entire wing to blend surfaces and remove high spots.
- | Cut 1" x 6" half-hard aluminum sheet into 3" pieces. Lightly sand aluminum surfaces for better gluing. Apply a bead of SUPER JET to half of a 3" aluminum sheet and glue it to wing T.E. as shown. When dry, apply glue to other half and then wrap it around T.E. Repeat for other 3" piece.

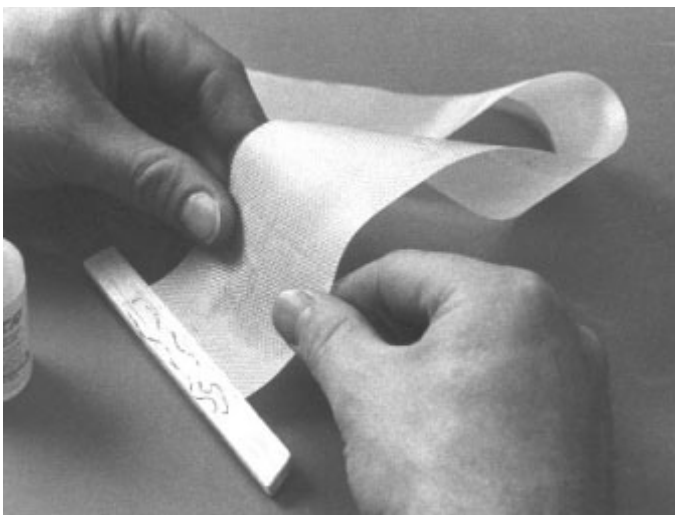

30. | Glue one end of 2½" wide nylon fabric to scrap wood. Let dry until the nylon is glued solidly to the balsa.

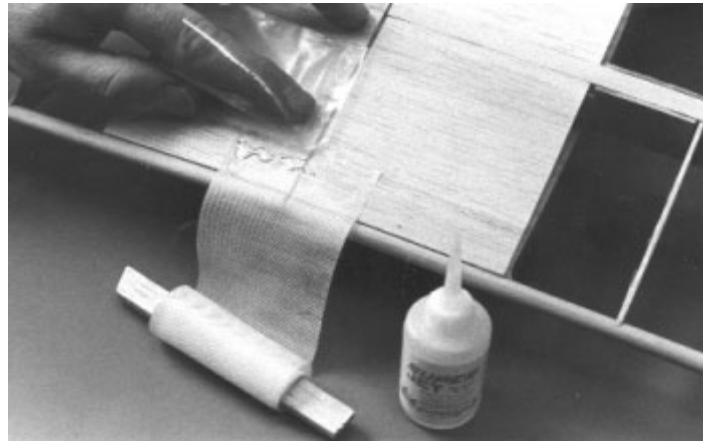

31. | Apply a line of SUPER JET at center joint on wing bottom and stick one end of 2½" wide nylon to it. Let dry until the nylon is glued solidly to the balsa.

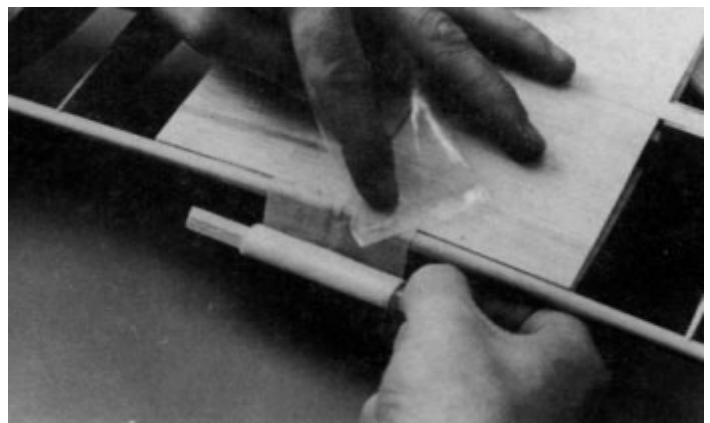
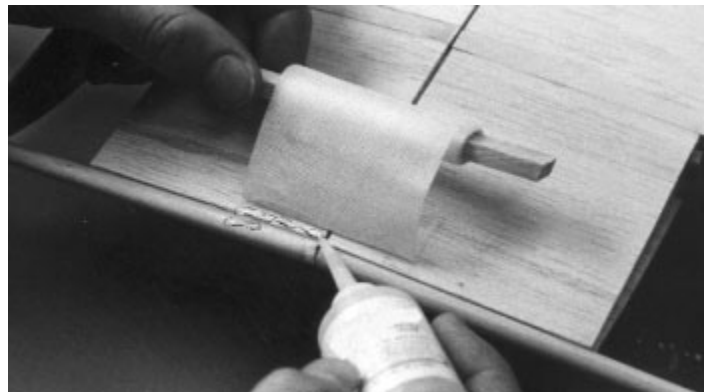

32. | Apply a squiggle of glue to wing and pull nylon fabric into it. Rub nylon into glue with your finger (cover finger with plastic bag or similar).

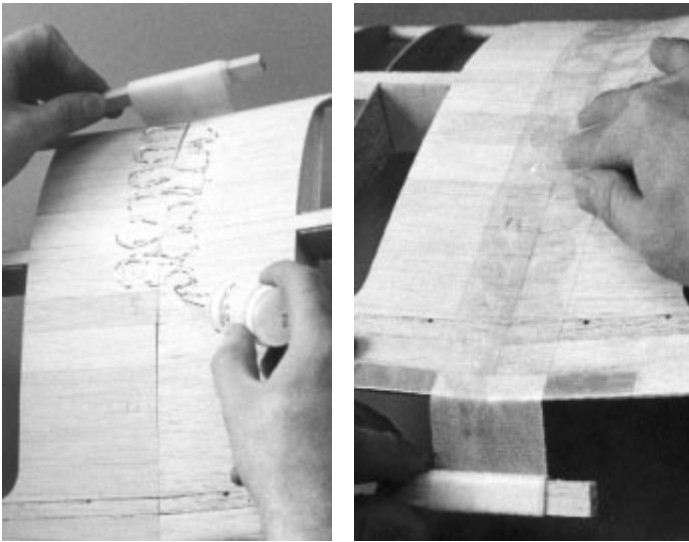

33. | Repeat gluing procedure and apply nylon around L.E., across top of wing, around T.E. and finally overlapping where you started on wing bottom.
- | After entire center joint has been wrapped with nylon, apply another coat of glue and force it down through the nylon. Let dry thoroughly.

**THIS COMPLETES THE "C" WING ASSEMBLY**

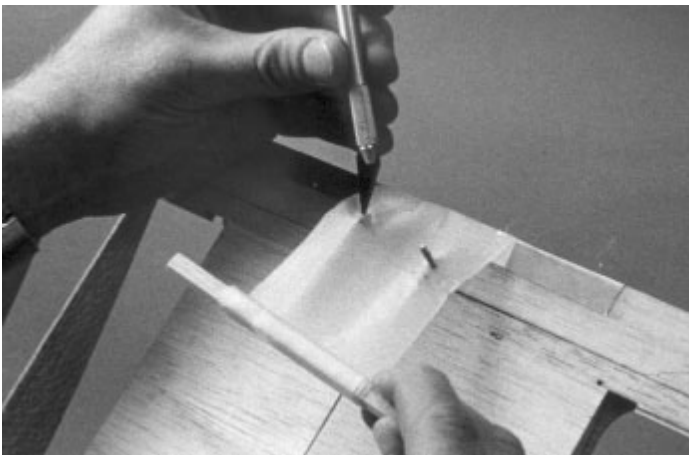

**For "A" or "B" wing, slit fabric over horns.**

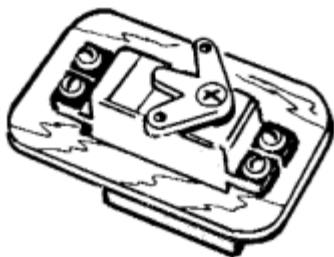

34. | Temporarily mount servo in die-cut mounting tray. See fuse side view on plan for added details of aileron servo installation.

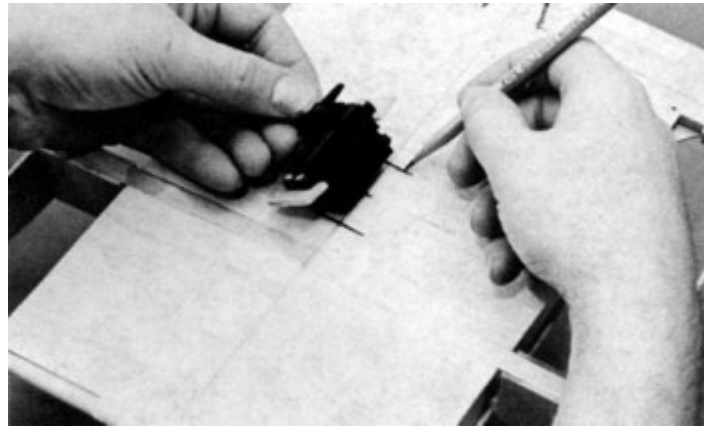

35. | Carefully position servo 1/2" behind bottom spar and mark size for opening.

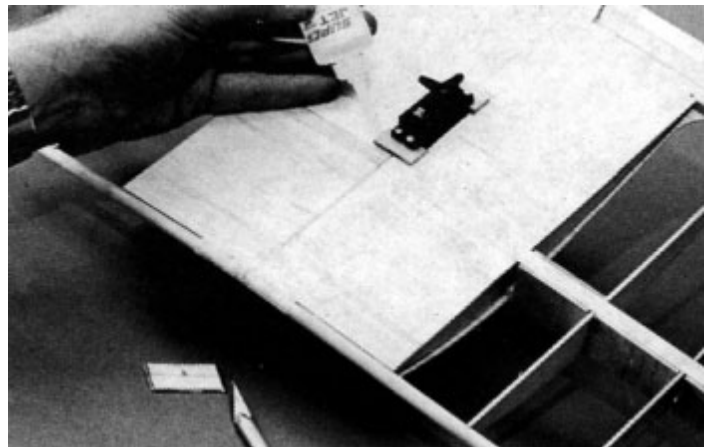

THE SERVO RAILS SHOWN IN THESE PHOTOS HAVE BEEN REPLACED WITH THE PLY MOUNTING TRAY (STEP 34).

- | Cut-out bottom sheeting. Remove material from rib No. 1 as required to suit your servo.
- | Glue servo tray to wing, and fill any gaps under the tray with slivers of scrap balsa. Avoid getting glue on servo!

**THIS COMPLETES THE "A" & "B" WING CONSTRUCTION. The servo should be removed before covering.**

# FUSELAGE ASSEMBLY

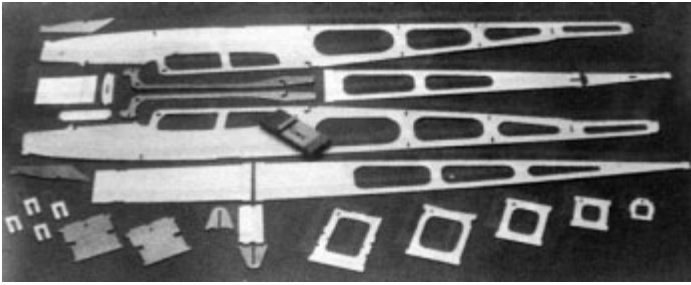

1. } Carefully remove all fuselage (fuse) parts from die-cut plywood sheets. Lightly sand any rough edges.

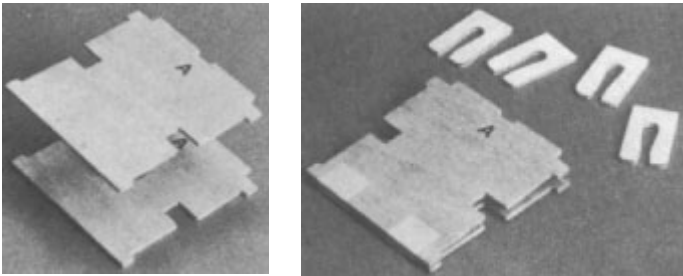

2. } With side stamped "A" facing out, position two 1/8" ply formers (firewall) together, matching all edges. To hold them in alignment, tape them securely together along one edge as shown at right. Have four ply clamps ready for next operation.

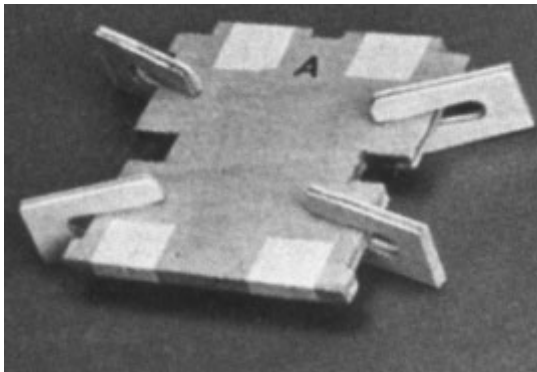

3. } Open firewalls and apply a liberal bead of glue to one part as shown at left.
- } Keep edges aligned as you close firewalls and tape opposite edge together. Squeeze firewalls together using die-cut clamps. When dry, remove clamps and tapes; set clamps aside for use later.

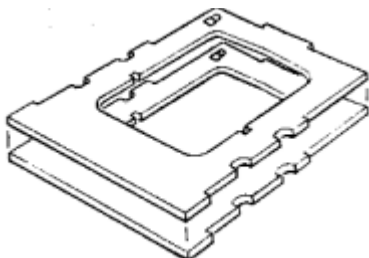

- 3a. } Repeat firewall joining procedure and make doubled Former "B".

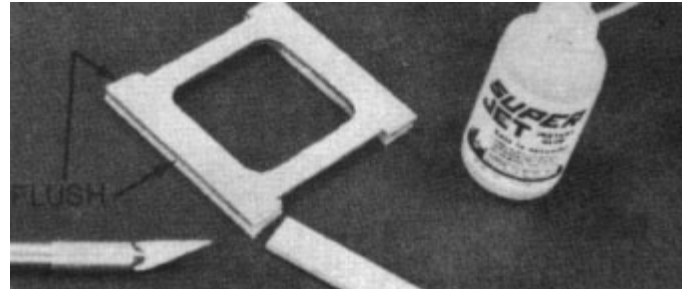

- 3b. } From 1/8"x1/2"x18" balsa, cut and glue strips to match formers as shown. Apply strips as shown. Note: Former "C" strip at bottom only.

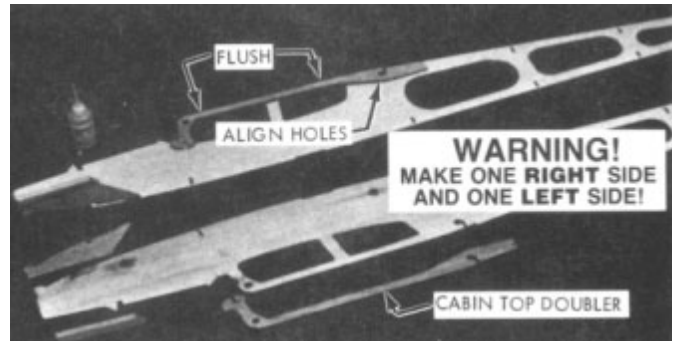

4. } Be sure sides are laid down left & right as shown.
- } **Temporarily** position cabin top doublers, nose doublers, and engine bearers on fuse sides. Check **fit** and **placement** of parts before gluing.

**NOTE:** Cabin top doublers **MUST** be flush! Holes must be aligned.  
**WARNING!** Make one left side and one right side!

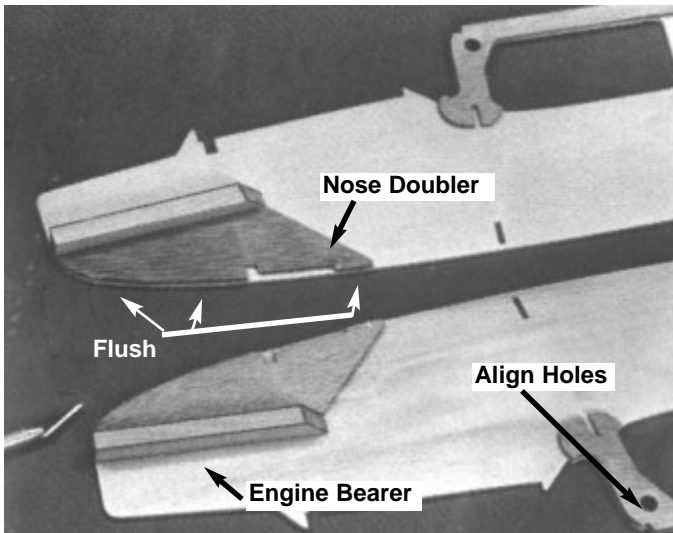

SMALL TRIANGLE SHAPED PIECES SHOWN ABOVE HAVE BEEN ELIMINATED FROM THE KIT, THEY ARE NOT NEEDED

- 1 Glue nose doublers to body sides, making sure to flush pans as shown
- 1 Glue engine bearers solidly to fuse sides and edge of nose doublers (longest edge to be glued to fuse side).
- 1 Glue cabin top doublers in place on fuse sides.

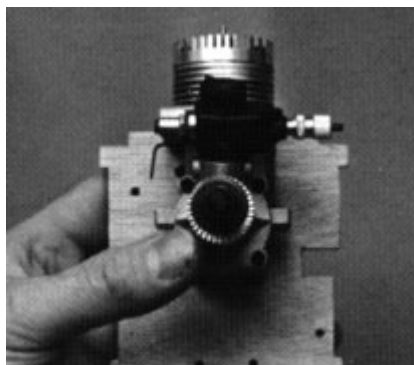
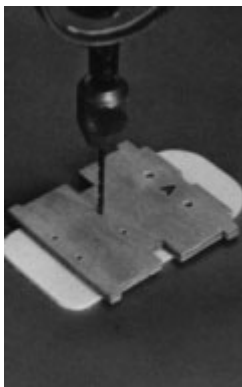

- 5a. 1 Drill two 3/16" diameter holes through firewall at upper punch mark locations as shown above (place scrap wood under backside while drilling to avoid split out).
- 1 Drill four 1/8" diameter holes through firewall at four lower punch marks.
  - 1 Study engine above; most engines have throttle arm on the side shown, and require two more 1/8" holes to be drilled as indicated for throttle and steering pushrods, If your throttle arm is on the opposite side, use the opposite locations shown with an X.

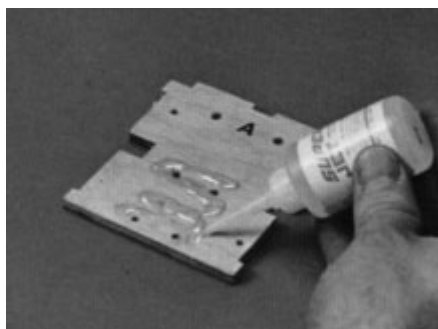

- 5b. 1 To prevent oil penetration, seal area around four holes as follows. Apply a bead of SUPER JET and smear it into the wood with your finger wrapped in plastic bag.

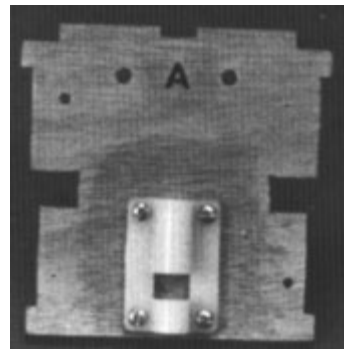

6. 1 Install nylon nosegear bearing on firewall using #4-40 x 1/2" machine screws and nuts as shown.
- 1 Place a drop of SUPER JET on nuts to lock them in place.

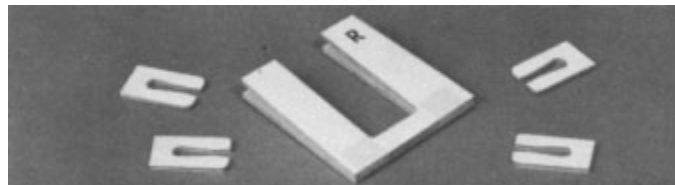

- 7a. 1 Position two 1/8" ply breakaway plates together, matching all edges including center cut-outs, To hold them in alignment, tape them securely together along one edge as shown .

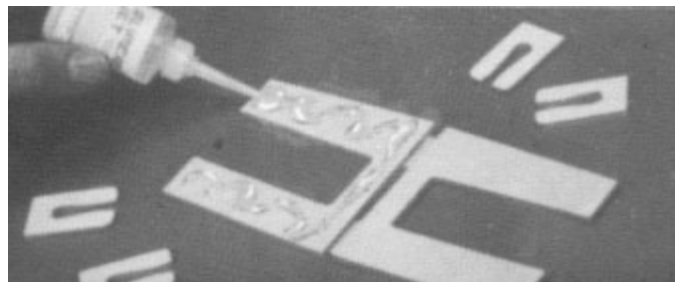

- 7b. 1 Open plates, and apply a liberal bead of glue to one plate as shown .

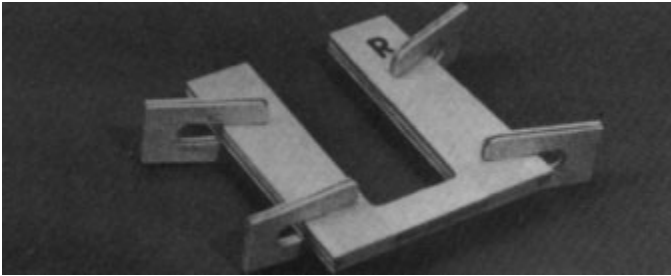

7c. 1 Keep edges aligned as you close plates and tape flanges together. Squeeze plates together using clamps. When dry, remove tapes and clamps. Set aside.

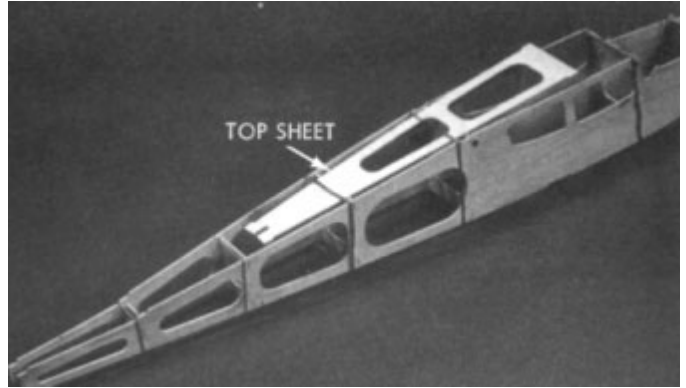

8c. 1 insert top sheet under rubber band at former C, and work it towards tail, slipping it under bands as you go.

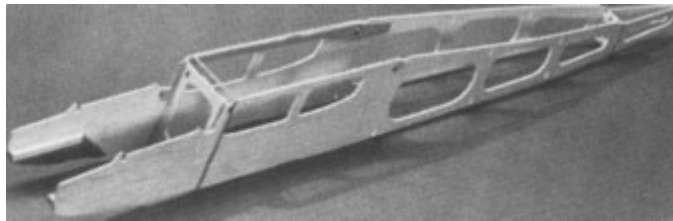
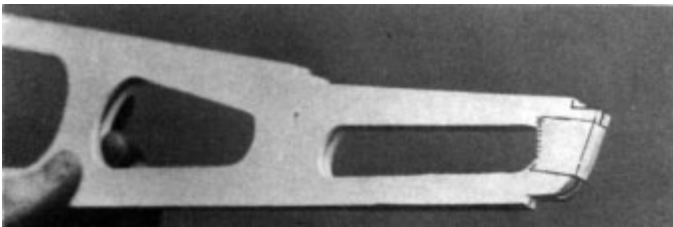

8a. 1 Place fuse sides one on the other, and tape rear together around the back end. Spread fuse fronts apart, and plug former "B" into holes in body sides. Hold parts together with a rubber band. Carefully spread fuse rear open, and plug former "F" in place, and hold with a rubber band. Remove tape from tail end.

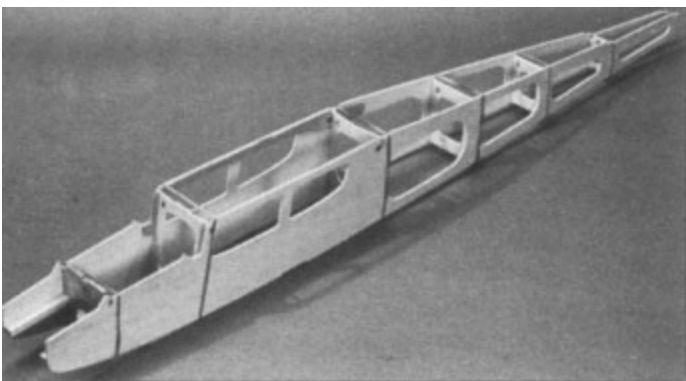

8b. 1 Install firewall & remaining formers "C", "D", and "E" in same manner, using rubber bands to hold parts.

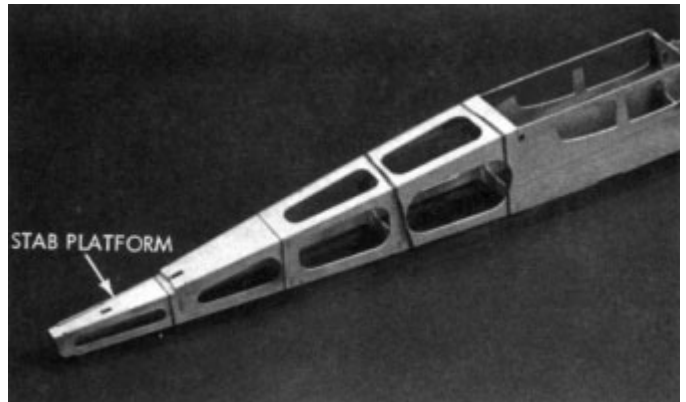

8d. 1 Lock tabs at both ends of top sheet into corresponding notches in fuse sides.  
1 Position stab platform between fuse ends, and hold parts in place with rubber bands.

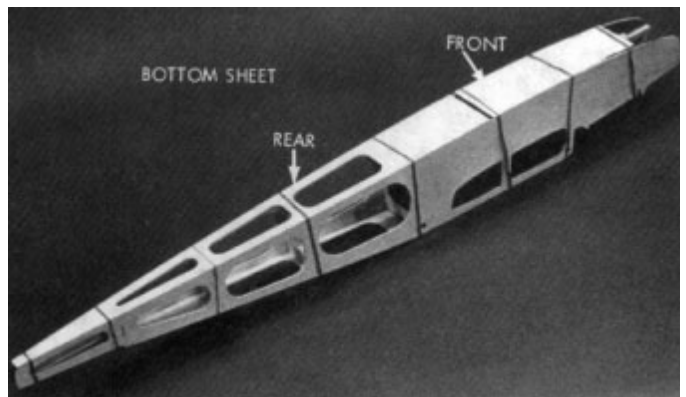

8e. 1 Position front and rear bottom sheets in same manner.



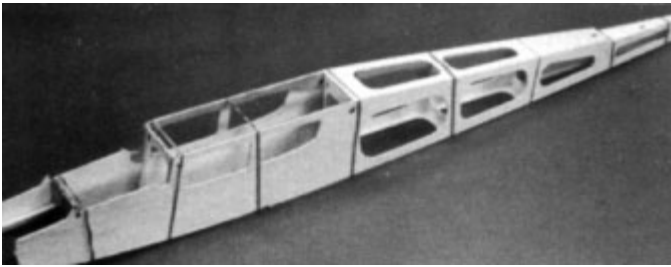

9. † Place fuse over TOP VIEW on plan sheet. Viewing from above, carefully align the fuse to match plan outline. If an area of the fuse is off, adjust that portion in the direction required.

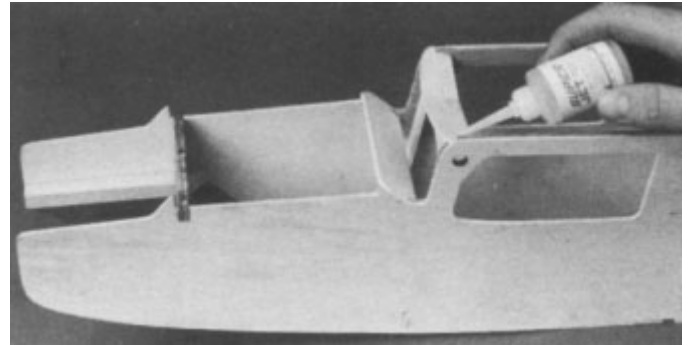

11. † Glue windshield top former and dashboard solidly in place.

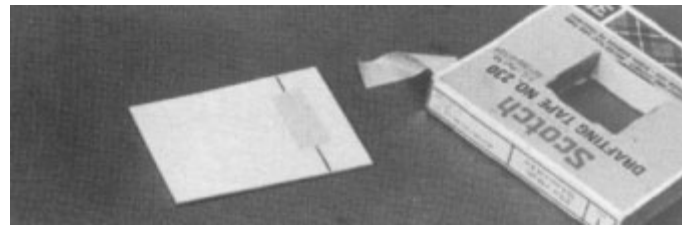
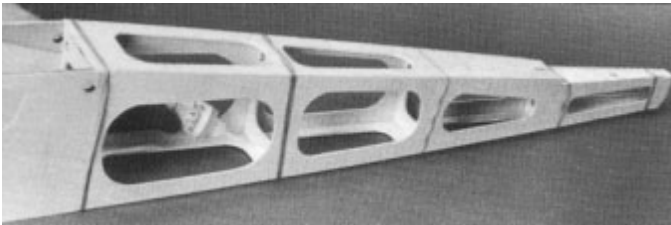

12. † Tape hatch cover and dashboard top together (as they fit from die-cut sheet).

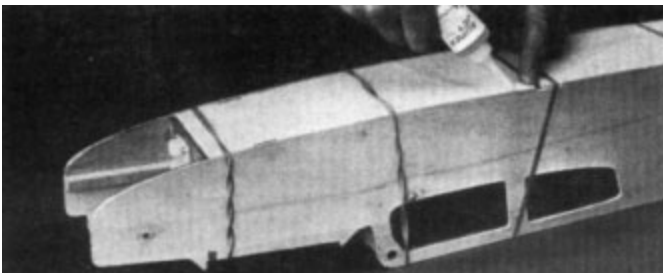
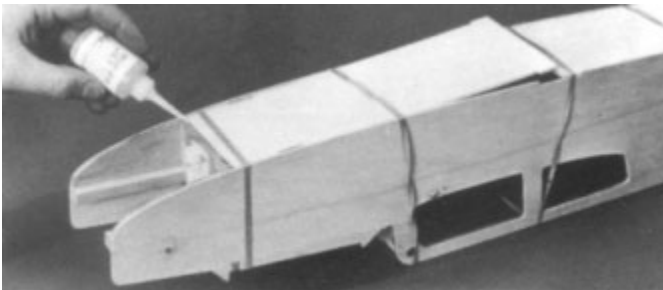

10. † When satisfied with alignment, permanently glue sides, formers, and sheet parts in place. Apply a bead of SUPER JET along all joints inside and outside, or from both sides in the case of formers — it will penetrate the joint and leave a slight reinforcing fillet.

**WARNING: DO NOT GLUE PARTS!**

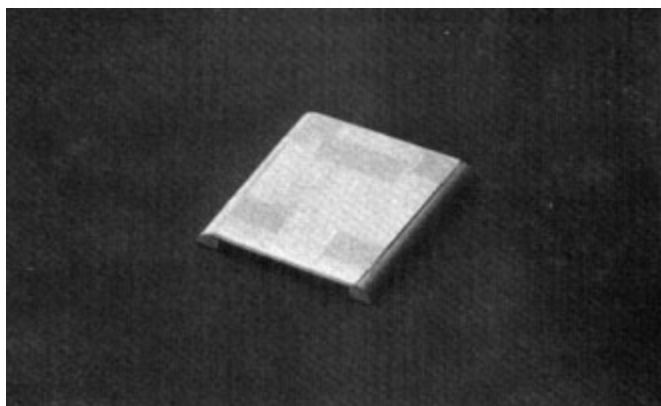

12b.1 Tape hatch supports to both sides.

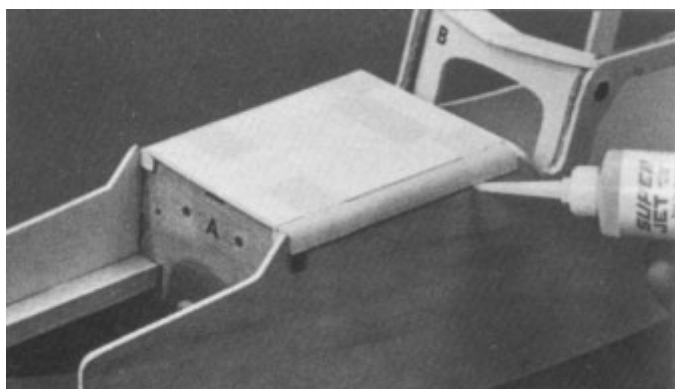

13.1 Position taped parts in place on fuse. Because of curvature, the hatch supports can overhang the sides slightly (the overhang to be sanded off later.) Glue only the hatch supports to the body sides.

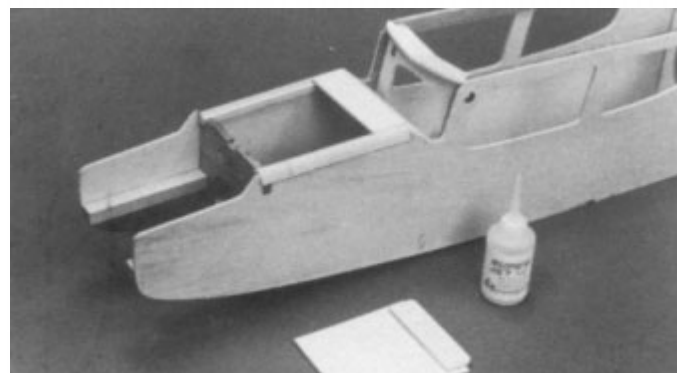

14.1 Remove hatch cover from fuse. Refer to plan for correct placement of ply tongue, then glue tongue to hatch cover. Try in place.

1 Glue dashboard top to hatch supports and dashboard.

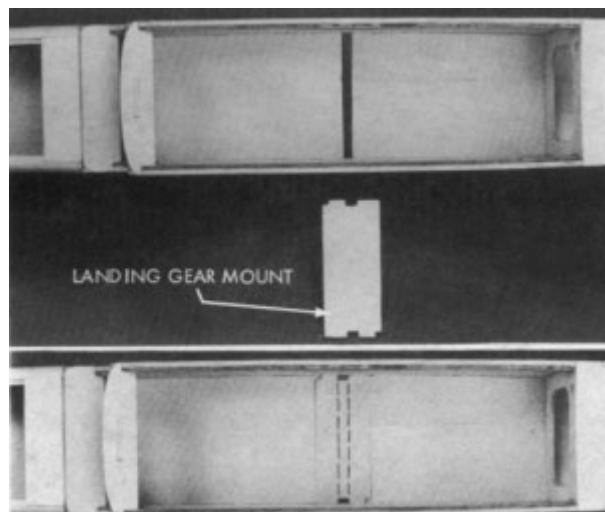

15.1 Place the landing gear (L.G.) mount on inside bottom of fuse. The cutouts at each end of mount must be positioned evenly over the slot in the fuse bottom, Glue mount in place.

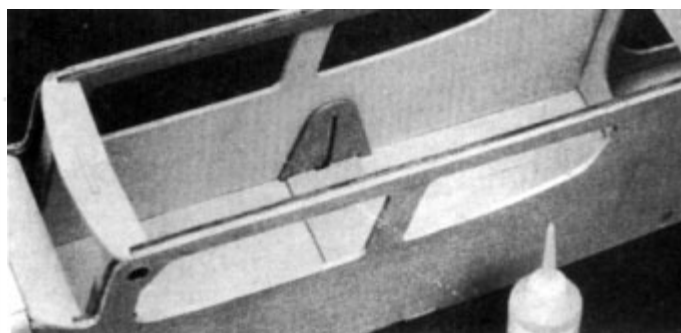

16.1 The L.G. braces interlock with L.G. mount. Glue braces solidly to fuse sides and L.G. mount.

# ENGINE INSTALLATION AND FUSE COMPLETION

For clarity, the engine installation is shown in many small steps rather than a few general ones. It is not difficult — just thoroughly explained.

NOTE: 4-Cycle engine installations are shown on next page.

1. † Mount propeller and spinner (if used) on your engine.

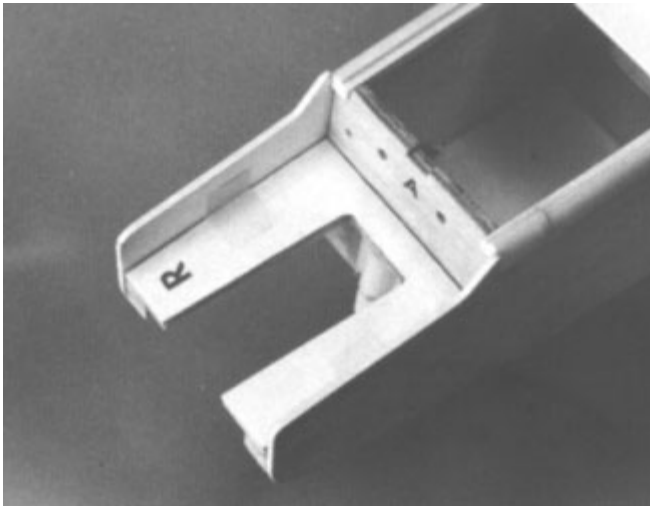

2. † Tape breakaway plate on engine bearers. **IMPORTANT:** The cut-out in the breakaway plate is purposely cut on an angle. The letter "R" on the breakaway must be on the Plight side as shown. The "Right" side is thought of as it would be to a pilot sitting in the cabin.

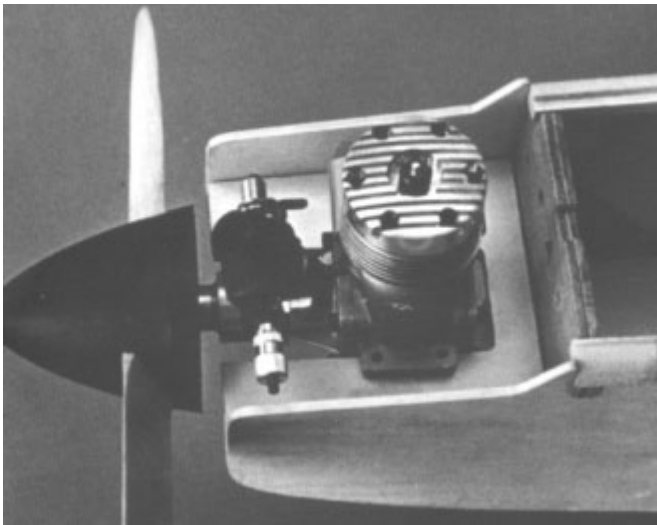

3. † Position engine on breakaway so there is approximately 1/8" between fuse front and spinner back (or propeller if spinner isn't used.)

- 3a. † Notice the engine in the top view on the plan is angled slightly to the right. This "RIGHT THRUST", although small, is important.



**LEFT SIDE DISTANCE SHOULD BE 5/16"  
LONGER THAN RIGHT SIDE**

View your model from above, and carefully measure distance from tail end to one propeller tip (propeller must be horizontal). Then measure other side of model in same manner. Left side distance should be about 5/16" longer than right side. For example, if right side measures 45-3/8", left side should be 45-11/16". Add 2-3 drops of SUPER JET to hold engine temporarily in place.

# TYPICAL 4-CYCLE ENGINE INSTALLATIONS

THE INSTALLATIONS ILLUSTRATED HERE ARE GUIDES:  
 DEPENDING ON YOUR ENGINE YOU MAY NOT BE ABLE TO FOLLOW  
 IT EXACTLY.

FOR CLARITY,  
 ONLY ENGINE THROTTLE & CHOKE DETAILS  
 ARE SHOWN IN SOLID LINES.

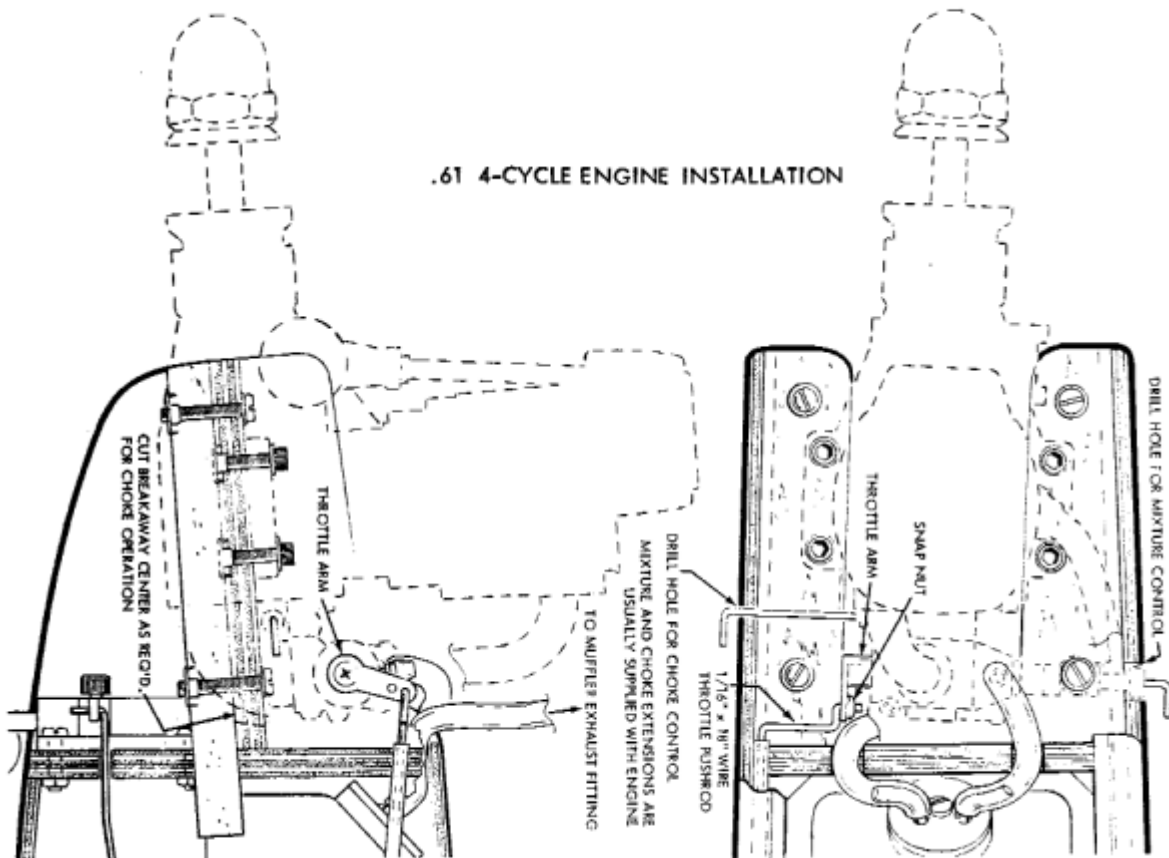
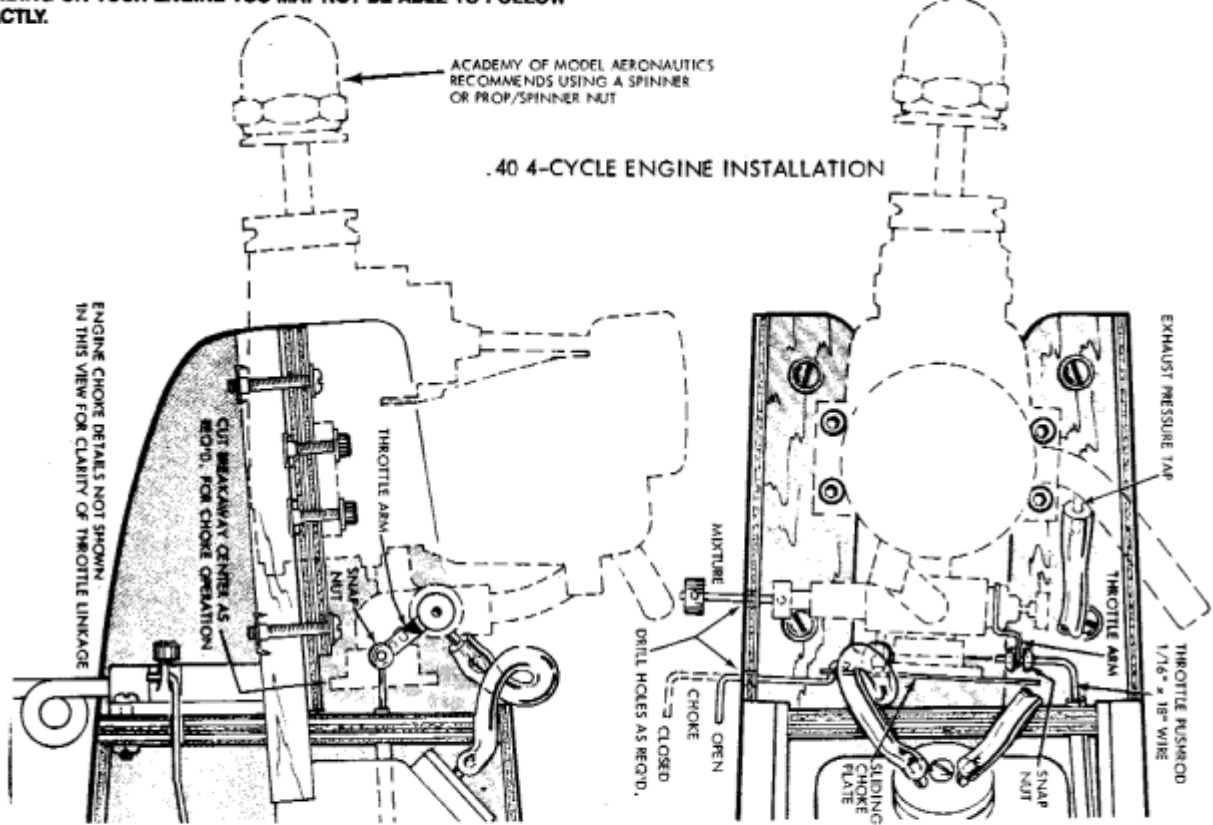

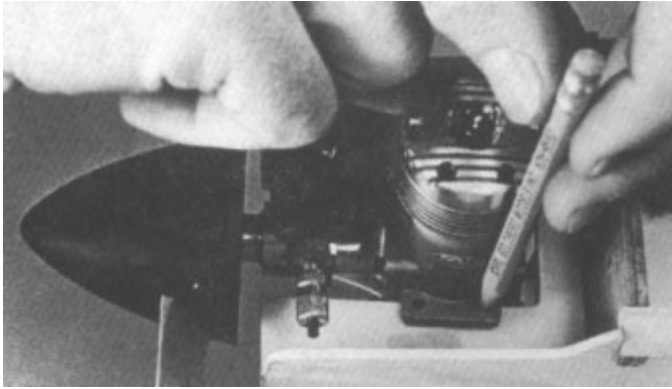

4a. 1 Mark straight down through engine mounting holes onto breakaway plate.

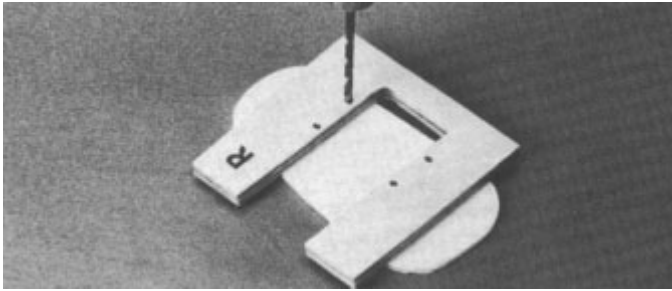

4b. 1 Remove engine and breakaway plate from fuse. Drill four 1/8" holes through breakaway at engine mounting hole locations (place scrap ply under parts when drilling to avoid splintering.)

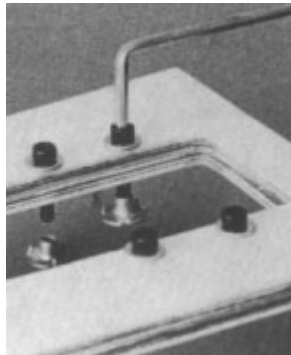
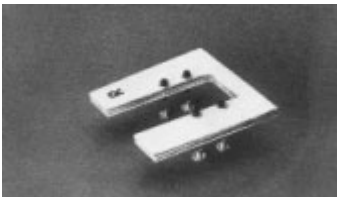

5. 1 Permanently install four blindnuts in bottom of break away using socket head screws (and washers) to pull blindnuts up into the screw holes as shown . Remove screws after seating blindnuts.

**PULLING BLINDNUTS INTO PLACE USING SCREWS**

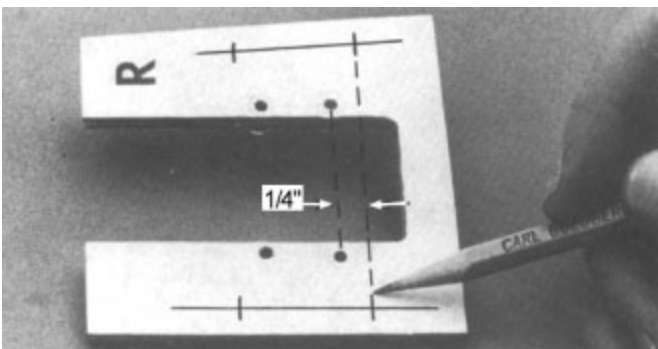

6a. 1 On die-cut lines, mark cross lines about 1/4" ahead of and 1/4" behind holes as shown.

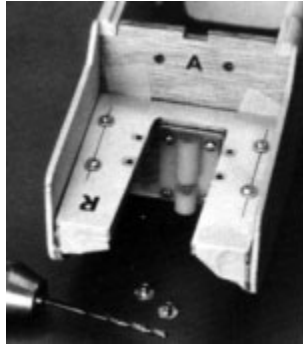
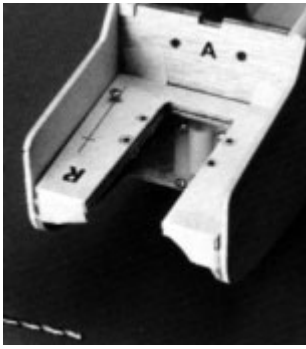

- 6b. } Tape breakaway plate in position. At one of the locations marked in step 6a, drill a 1/8" hole straight down through it and engine bearer. Insert a #4-40 x 3/4" soc. head screw through hole.
- 6c. } Continue this procedure, one hole and screw at a time, until all four screws are in place.
- 7. } Remove breakaway from fuse.

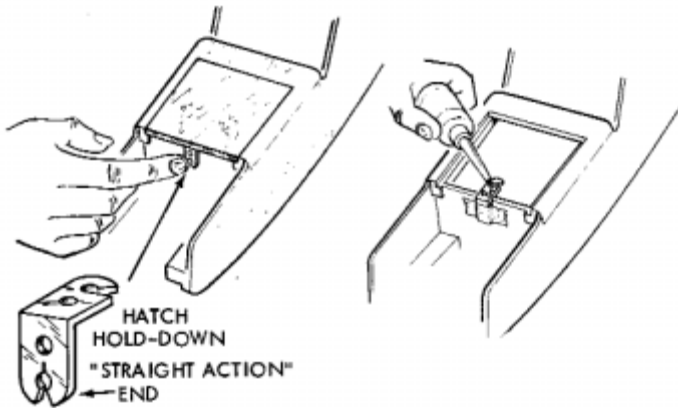
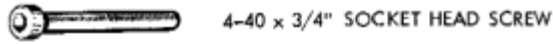

- 8. } Position hatch cover on fuse. Press hold-down against front of firewall and up against bottom of hatch cover as shown. "Straight action" end should point towards fuse bottom. Tape in position.
- } Remove hatch cover and apply SUPER JET to hold-down. Replace hatch on fuse, gluing it to hold-down. Let dry.



- } Secure hold-down to hatch with two #2 x 3/16" screws.

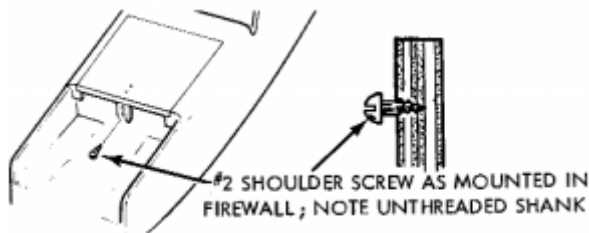

- } Set hatch in position on fuse. Mark location as shown for #2 shoulder screw. Install screw in marked location, exposing enough unthreaded shank to engage hold-down. Snap on and off several times.



- 9. } Carefully remove side windows from vac-formed sheet by cutting on lines (about 1/4" all around windows).
- } Using no glue at this time, temporarily fit windows into fuse openings. If they fit too tight, causing them to bulge, remove and lightly sand openings the minimum required for good fit. Remove windows from fuse and set aside until later.

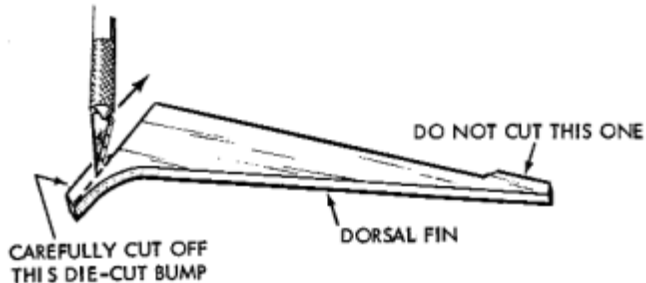
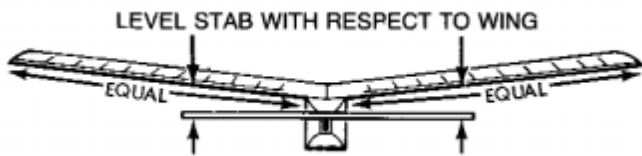

10a.} Temporarily install wing hold-down dowels in fuse. Rubber band wing in place on fuse, making sure it is centered. Viewing model from rear, see if stab sets level with respect to wing.

} Sand stab platform area as may be necessary to provide a good level fit for stab. Do not alter the die-cut angle of the fuse sides.

} Center stab on fuse, measuring to obtain equal distance from side to side, and from nose of fuse to rear corner of each stab tip ( see dimension "C" in Final Assembly section). Pin in place.

10b.} There are two "bumps" at ends of 1/4" balsa dorsal fin. The bump at the short end must be cut off (the other bump fits into fuse notch). Watch grain and very carefully trim it off. Smooth this edge with a few light passes of the sanding block.

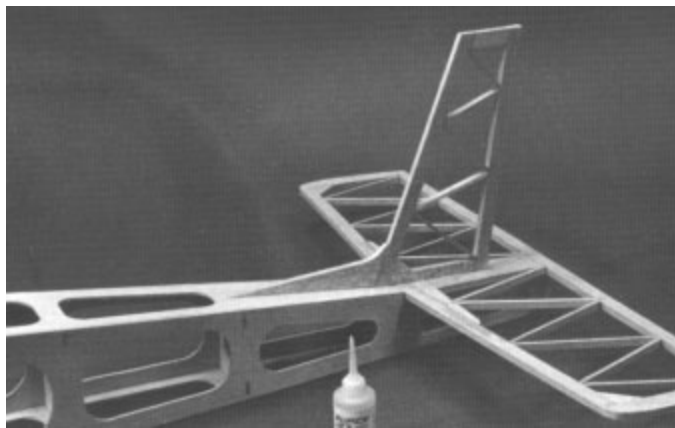

10c.} Trial fit fin in place. Glue dorsal fin to main fin but not to fuse, as shown. Finish sanding.

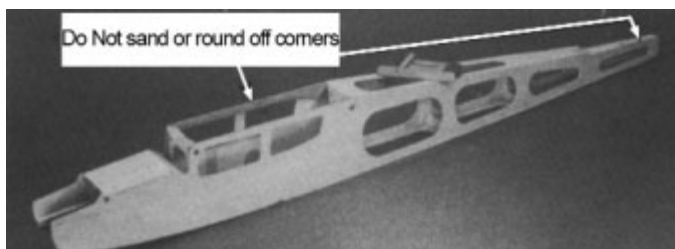

11. } Flat sand fuse and round off corners, except in the following areas: top of cabin, top of tail mounting area, and window openings — repeat: do not sand these areas, except very lightly to remove burrs!

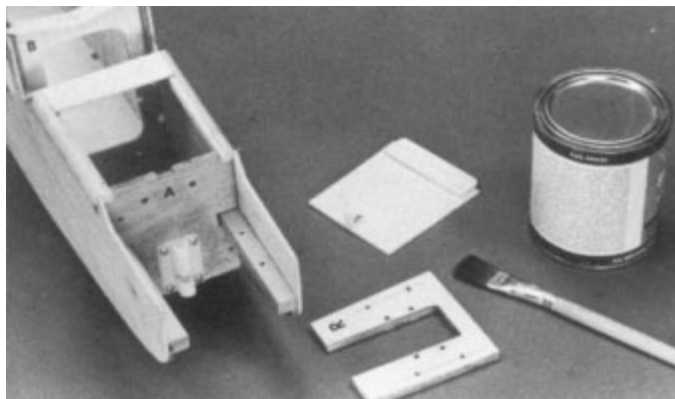

12. } To protect the engine and tank areas from becoming oil soaked, they need to be "fuel-proofed". Either polyurethane enamel, SUPER JET, or epoxy, is good for this. Poly urethane is available in colors so you can match close to your color scheme.

} Apply your fuel-proofer to entire engine area and break-away plate, inside tank compartment, and bottom of hatchcover. Open up screw holes with toothpick while paint is wet. Let dry thoroughly.

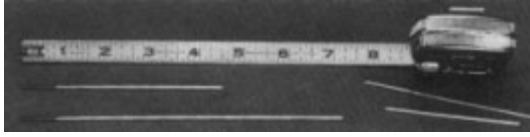

13a.} From the threaded end of two 10" rods, measure and cut one of the rods to 7" and the other rod to 4½".

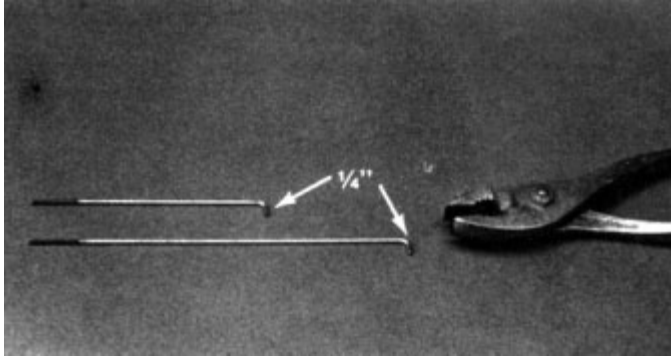

13b.} At cut end of rods, bend down about 1/4" making a square hook.

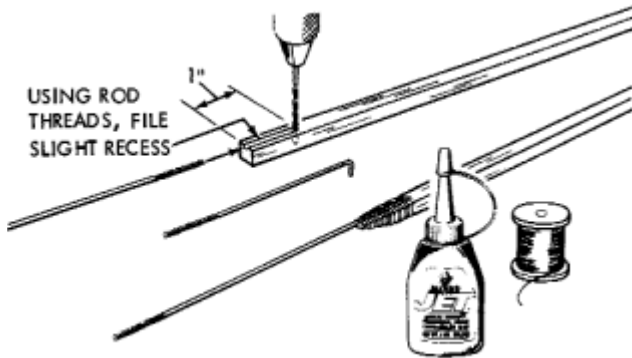

13c.} Using the threaded end of a rod, file a slight recess 1" long at one end of each 5/16" square x 24" balsa pushrod .

- 1 } Drill a 1/16" diameter hole 1/4" deep at end of recess in both pushrods.
- 1 } Glue rods into balsa pushrods as shown.
- 1 } When dry, taper ends of pushrods and round off corners, Bind with strong thread, coat with glue and let dry. The other end of the pushrods is completed later during radio installation .

**THIS COMPLETES THE FUSELAGE ASSEMBLY**



# CONSTRUCTION OPTIONS

## BOLT-ON WING OPTION



1/8" Balsa  
(2 REQ'D.)



1/8" PLY (FUSE SCRAP)  
(2 REQ'D.)

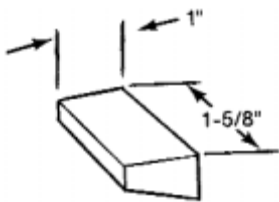

Balsa T.E.  
FILLER BLOCKS  
(2 REQ'D.)

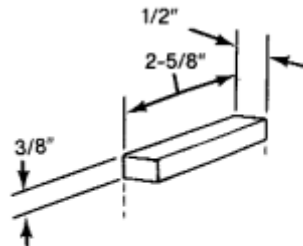

HARDWOOD FUSELAGE  
BOLT BLOCKS  
(2 REQ'D.)

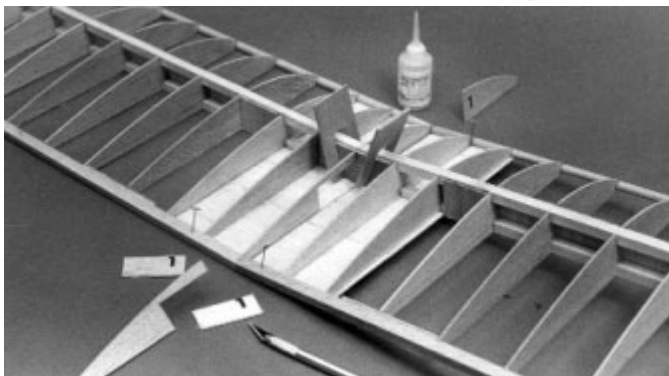

FRONT VIEW

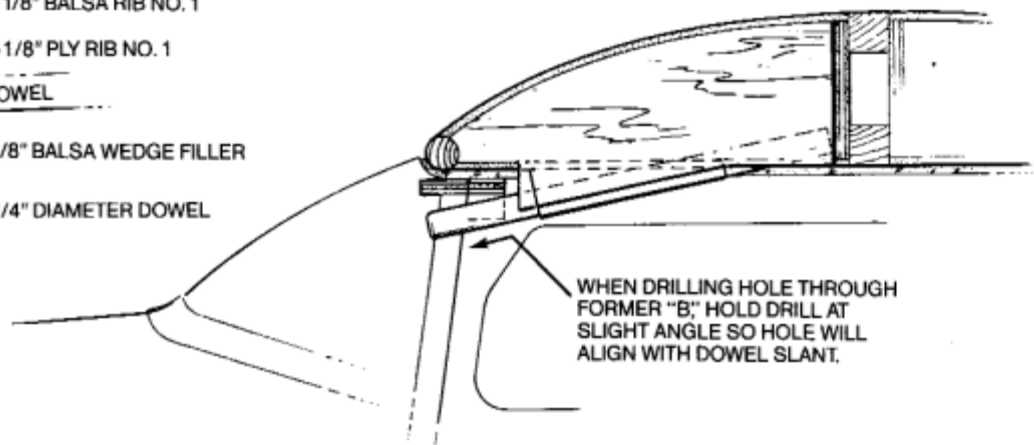
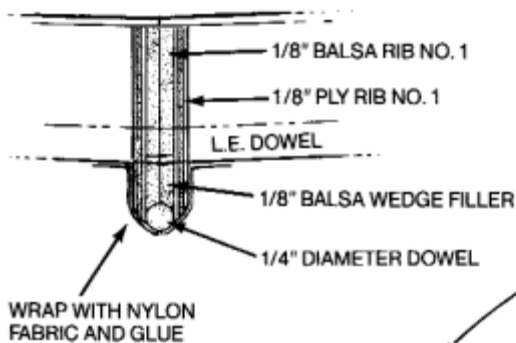

### Materials not included;

- ‡ Two 1/4"x 20 nylon wing bolts (CG #585)
- ‡ 1/4" dia x 3" wood dowel
- ‡ Two 1/2" x 5/8" x 2" hardwood blocks (fuselage mounting)
- ‡ Two 5/8" x 1" x 1-5/8" balsa blocks (wing filler block)
- ‡ One 1/4x20 tap
- ‡ Klett Safety Driver (CG#610)

NOTE: A Bolt-On wing looks neat and clean, but is more likely to be damaged in a crash than a rubber-banded wing.

### MAKE THE FOLLOWING PARTS:

Using the full-size templates on Wing Plan Sheet 2 as a guide, make:  
 Two 1/8" balsa Number 1 Ribs.  
 Two 1/8" plywood Number 1 Ribs (out from fuselage scrap).  
 Refer to drawing at left for dimensions and make:  
 Two balsa Wing T.E. Filler Blocks.

Refer to drawing at left and make:  
 Two hardwood Fuselage Bolt Blocks

Wing Procedure (substitute the modifications below where applicable).

1. ‡ For Bolt-On wing there are only two part changes, instead of the 5/64" die-cut No. 1 Ribs, use the new 1/8" balsa No. 1 ribs. Balsa filler blocks must be glued inside the wing at the Trailing Edge. The instructions will remind you when to add these parts.
2. ‡ After wing is completely assembled, cut a 1/4" wide opening through the bottom sheeting for the 1/4" diameter wing dowel. Glue dowel into wing and glue wedge shaped filler between dowel front and bottom sheeting.
3. ‡ Cut two 1/8" wide slots through wing bottom sheeting on either side of dowel location. Apply epoxy or Slow Jet to side and top edges of 1/8" plywood rib, and slide it into position next to rib 1 and dowel. Glue remaining rib to opposite side.
- ‡ Glue scrap 2-1/2" wide nylon fabric around dowel and ply ribs up around wing bottom.

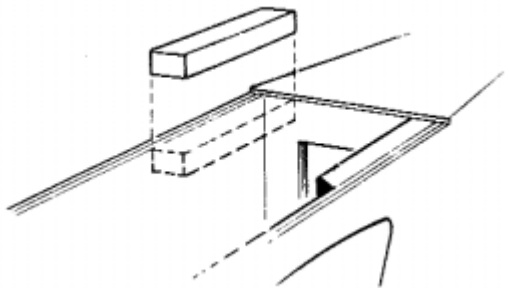
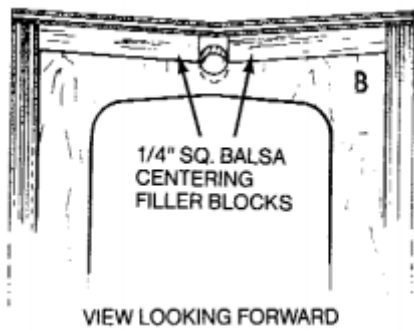

## FUSELAGE PROCEDURE

1. | Position and glue two hardwood mounting blocks securely inside the fuselage as shown using Epoxy or Super Jet. Glue them well, these glue joints must be strong.
2. | Drill a 1/4" diameter hole through former "B". Locate hole by holding drill up against bottom edge of cabin top doubler and then drill through former at a slight angle so hole matches downwards slant of dowel.
3. | Cut and glue two centering filler blocks under windshield top former as shown, allowing center clearance for dowel.
4. | Position wing on fuselage and press T.E. down to rest on fuselage top. Measure for equal distance from wing tips to rear end of model and adjust wing so it is setting square on fuselage. Hold wing in place with tape.
  - | Measure 2" from wing TE. and 1/2" in from fuselage sides. Drill two holes 13/64" diameter down through wing and fuselage mounting blocks.
  - | Remove wing. Enlarge WING HOLES ONLY to 1/4" dia.
  - | Cut threads in FUSELAGE HOLES with 1/4-20 tap.
  - | FINAL FITTING. After applying optional foam wing seating tape the wing may not fit in place. To correct this, file dowel hole slightly higher (towards fuse top) using a rat-tail file. Continue until wing fits flat on top of fuselage.

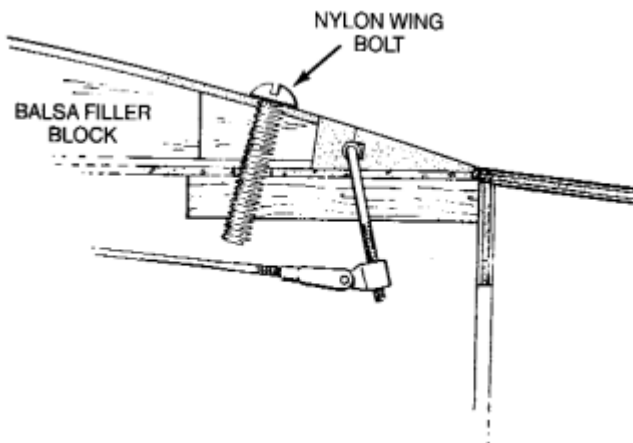

# ELECTRIC POWER OPTION

**ASTRO GEARED 25 COBALT MOTOR**

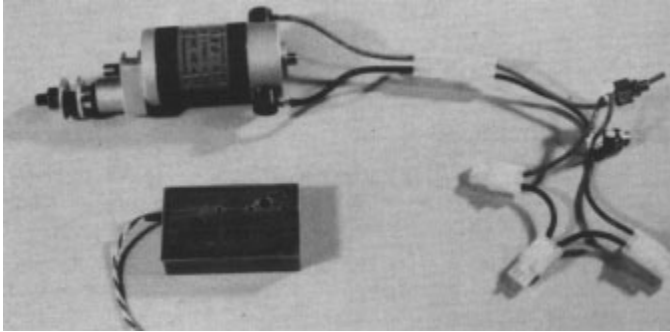

**ASTRO  
ELECTRONIC MOTOR  
SPEED CONTROL**

**SWITCH, CHARGER,  
AND CONNECTOR  
HARNESS**

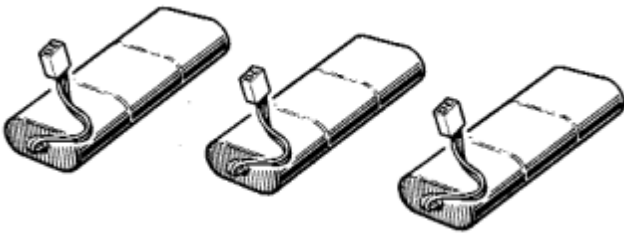

**THREE 1200 MAH BATTERY PACKS**

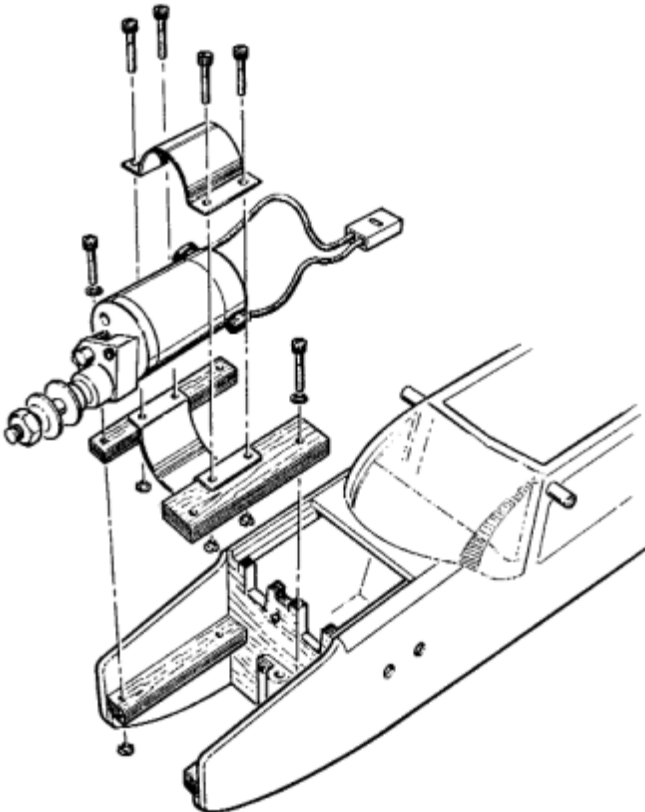

ELECTRIC flying is clean and quiet. There is no messy engine exhaust oil so your model stays clean. The items below are available from Astro Flight Inc.

**Materials not included:**

- 1 Cobalt 25 Electric Motor (Geared)
- 1 Electronic Speed Control
- 1 Three 1200 MAH batteries
- 1 Three Battery Switch Harness
- 1 "Beam" type motor mount
- 1 DC Charger (for field charging)

**The following modifications must be made to your Eagle:**

1. 1 Use a coping saw to cut two "U" shaped notches in the top of the firewall as shown, one (or each motor wire, These openings provide for easy installation and access to all electrical connections and cooling for batteries.
2. 1 Cut the ply breakaway plate into two mounting rails to dimensions shown in firewall front view.

Now install the electric motor, switch/connector harness and batteries as shown in the illustrations. The Astro Flite Cobalt .25 Geared Motor system as shown here is recommended.

**IMPORTANT!** Read and follow the manufacturer's instructions regarding the installation and safe operation of each component of your electric motor system. The motor, batteries, etc. are very powerful and must be operated as recommended by the manufacturer.

Three 1200 MAH battery packs are required for power, These batteries should be installed under the wing balance point as shown and braced with plywood strips so they cannot move inside the fuselage, Recharging the batteries is accomplished through a jack mounted next to the motor On/Off switch. Recharging can take as much as 45 minutes. Batteries should always be allowed to cool before charging -cool batteries accept more charge than when warm.

**IMPORTANT!** Read and carefully follow your battery charger instructions, improper charging can ruin your batteries.

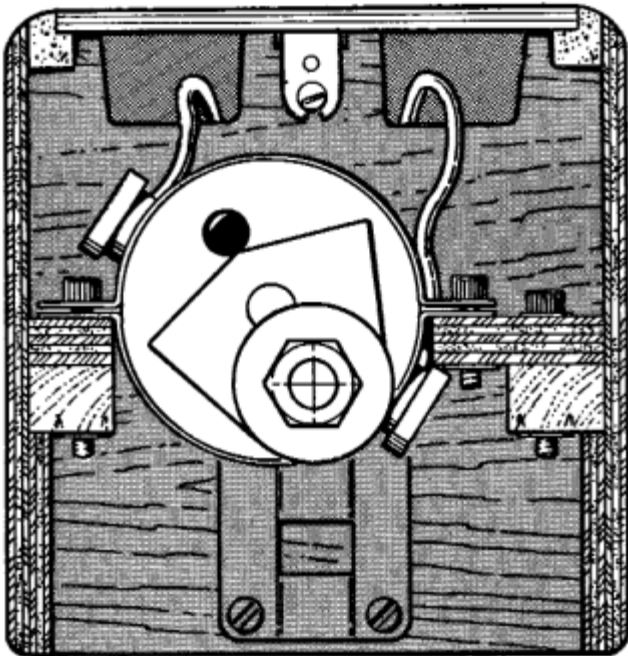
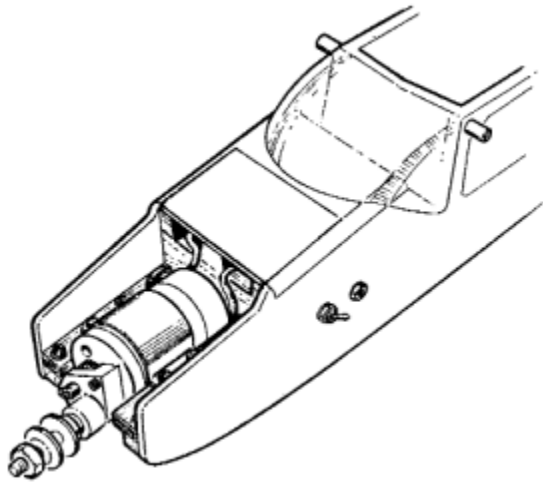

As the motor uses battery power the batteries will become warm. Cooling air enters through the firewall openings and exits the fuse tail end. In flight, this air movement will help cool the batteries.

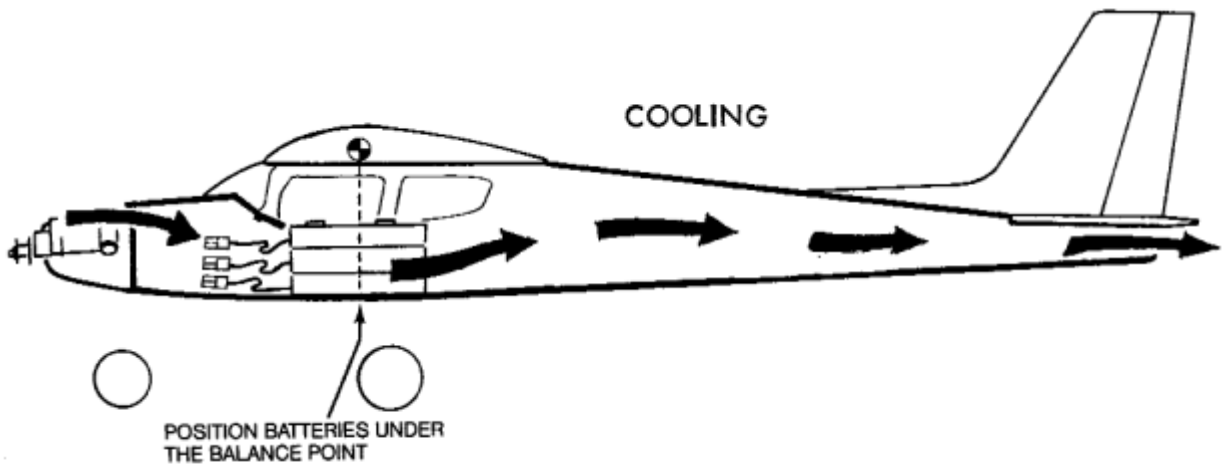

# OPTIONAL FLOAT INSTALLATION

**FLOATS** make any large pond or lake your runway. Water flying adds a new dimension to your flying fun. CG Super Floats are recommended because they are easy to build and perform well. Floats can be added at a later time with little modification to your model.

- ‡ Superfloats(CG#296)
- ‡ Two 5/32" dia. x 36" wires (for struts)
- ‡ Finishing materials (see float instructions)

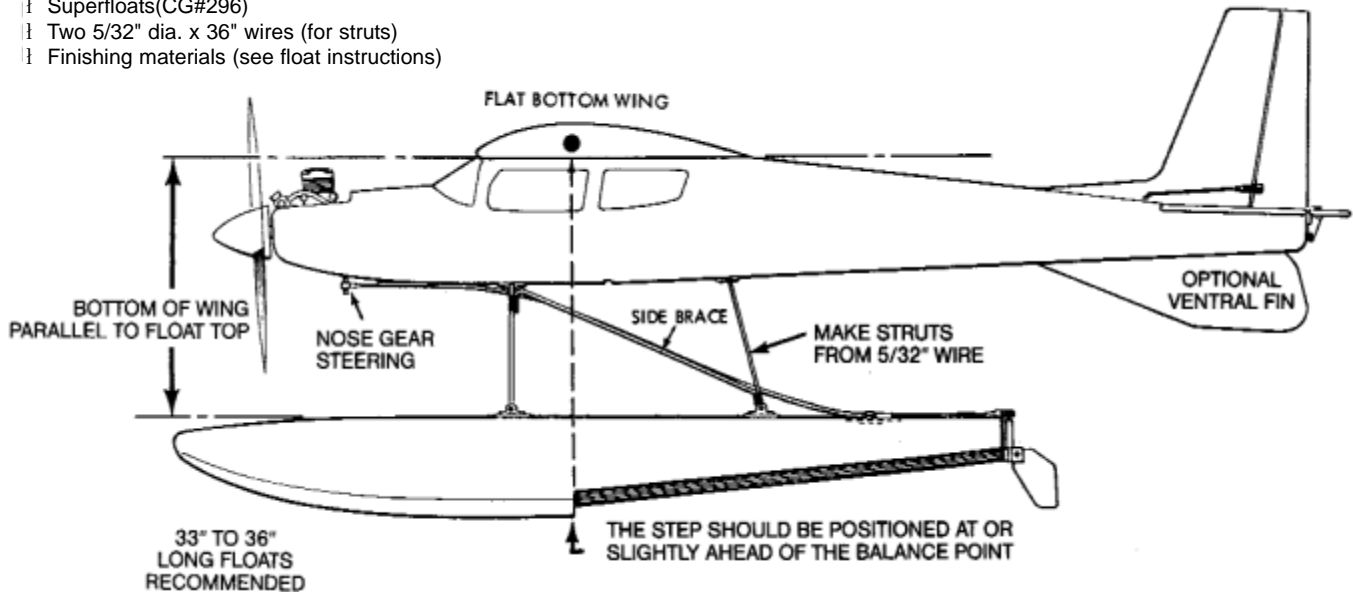

CG "SUPER FLOATS." A complete kit, easily adapted to fit the Eagle, Includes information on construction, installation, and flying techniques.

# OPTIONAL TAIL WHEEL INSTALLATION

(Materials not included)

**TAILDRAGGER.** Tail draggers are especially well suited for flying from rough or unimproved runways (use the next size larger wheels). Tail draggers are not recommended for beginning flyers because they are a little more difficult to handle than nose wheel airplanes. You can easily change your Eagle to a tail-dragger later on.

- ‡ Klett .40/.60 Landing Gear (CG#256)
- ‡ Tail Wheel Bracket (CG#460)
- ‡ #4 Blindnuts (CG #571)
- ‡ No. 4 x 1/2" Socket Head Screws (CG #504)
- ‡ 3/4" diameter tailwheel
- ‡ 1/16" dia. x 6" wire (for strut)

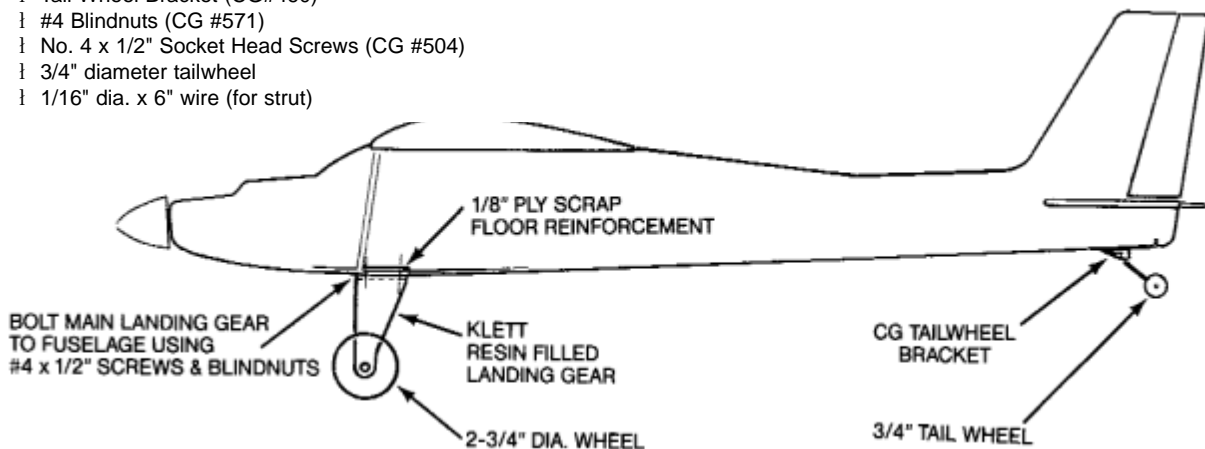

MOUNT LANDING GEAR DIRECTLY UNDER WING LEADING EDGE

We show a fixed tailwheel. A steerable tail wheel isn't needed; a blast of propwash will easily rudder your Eagle for ground taxi.

**GENERAL.** Any irregularities in the wood surface will show on the covering, so a good covering job should be preceded by careful sanding, filling of nicks and dents [we recommend CGM Model Mate™ balsa filler), and then more sanding. For this final sanding, use fine sandpaper (240-320 grade) and a sanding block.

The easiest way to finish your model is to cover it in one color of UltraCote and then apply trim in a second color, using either UltraCote or sticky-back UltraCote plus. Both UltraCote and UltraCote plus can be applied on top of each other without forming gas bubbles. (If you use another brand of covering, follow manufacturer's instructions.)

You may also paint over polyester plastic films, as well as the plastic parts of your aircraft, using modeling grade polyurethane or epoxy paints. We recommend UltraPaint one-step epoxy to best coordinate with your favorite UltraCote colors. For good paint adhesion, make sure the area to be painted is washed clean, dry, and completely free of any oil or dust. When painting on plastic covering, you may wish to dull the surface to be painted with 000 steel wool. Mask the design with vinyl tape.

**NOTE:** Before starting, it's a good idea to do a layout of the covering pieces you will need to cut from the covering rolls, so that you make efficient use of your material. You can draw patterns on UltraCote's paper backing. Be sure to leave a little extra material, so you can go around the edge of the section you are covering.

### COVERING THE WING

Before starting, carefully read the instruction that come with your covering. You will cover the bottom of the wing first, and then cover the top.

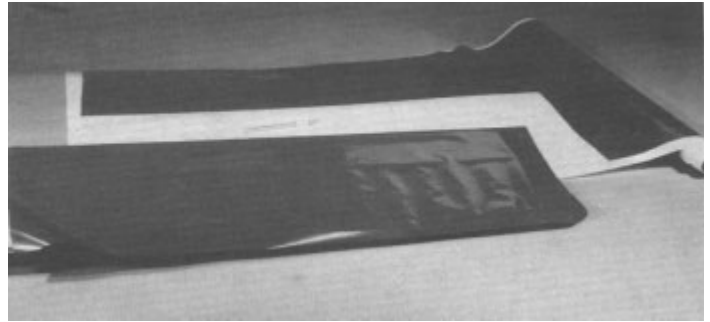

- 1 Using a fresh model knife blade or razor blade, cut a piece of covering material at least 1" larger than one-half of the inboard wing bottom panel.
- 1 Remove the protective backing paper and lay the covering over the bottom of the wing, making sure there is a slight excess for wrap-around at the L.E., T.E., and wing tip.

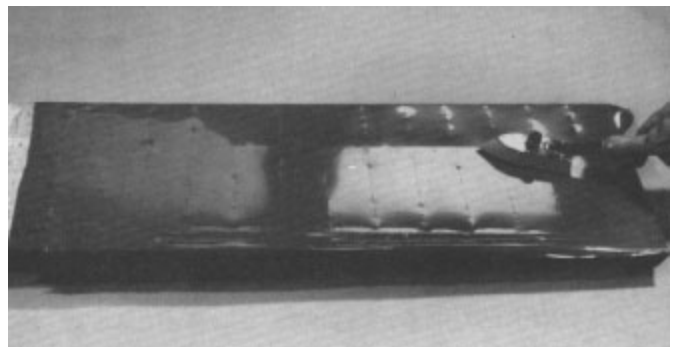

- 1 When using UltraCote, work from the center out and tack to the ribs, sheeting, and other wood surfaces, using medium heat. Gently rub the covering with a soft cloth to set it in place.

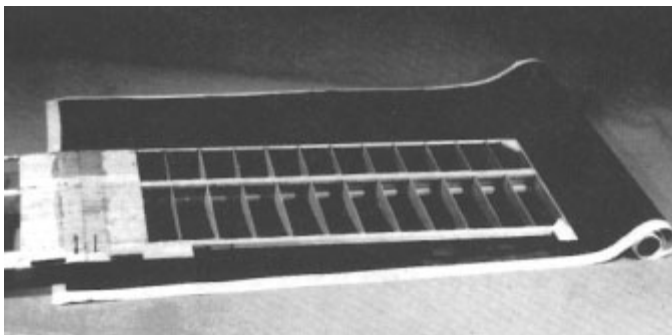

- 1 Set the covering iron to the proper temperature. Test it by laying a small strip of covering over a scrap piece of balsa and firmly pressing with the iron. Make sure the iron is hot enough to activate the adhesive, but not so hot that it burns the covering.

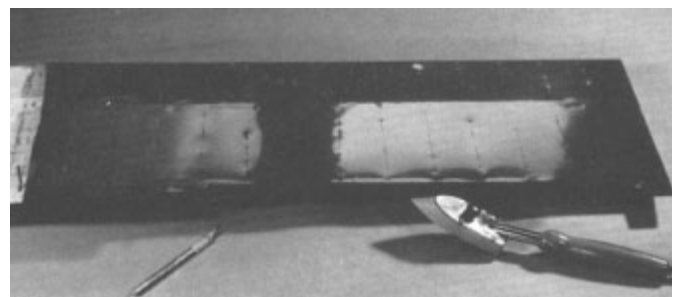

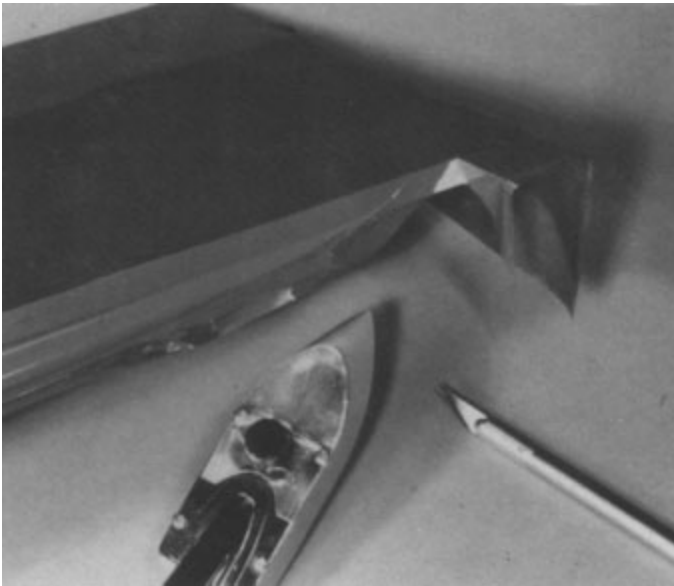

- 1 For inside corners, slit covering and fold it around the edges.
- 1 Using your iron (or a special covering "heat gun,") set at relatively high heat, shrink the covering tight. Neatly trim off any surplus.
- 1 Following the same procedure, cover the remaining wing sections, both top and bottom. Be sure to overlap seam at least 1/4". The ailerons should be covered in the same manner, beginning with the top and then covering the bottom, and overlapping the seams.

**NOTE:** Once the aileron sections have been covered, and while the hinge locations are still fresh in your memory, immediately slit the covering to open up the hinge holes. (Refer to the plan for help in locating the hinge holes.)

For best results, a darker color should go over a lighter one. Smaller designs should be positioned and tacked in place at one end. Then, work the iron down the rest of the design, smoothing out the design as you go. Larger designs (such as sunbursts) should be positioned and the widest end tacked down first. Then, working towards the narrow end, iron the design down.

## INSTALLING WING TIPS

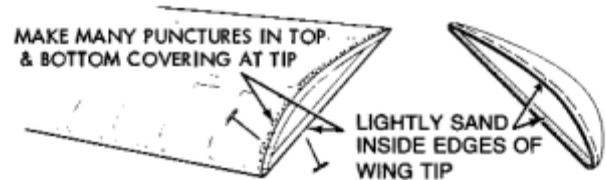

For better bonding of plastic wing tips, use a pin to make a series of many punctures through the UltraCote® into the top and bottom edges of the tip ribs. In addition, lightly sand the inside edges of the plastic wing tip in the area that will contact the tip ribs.

- 1 Apply a bead of SUPER JET to the top and bottom edges of the tip ribs and slip the plastic wing tip into place.

## TRUING THE WING

After the wing has been covered, you must check to make sure it is free of warps.

*Truing the wing is an important step, and should not be rushed or omitted.*

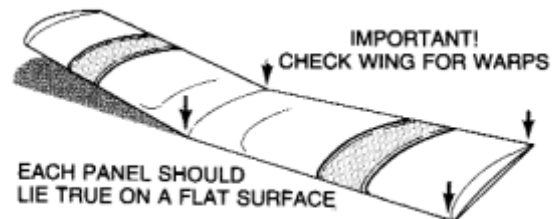

- 1 Set one half of the wing on a flat surface to detect warp. To counter any warp, twist panel slightly in the direction opposite to the warp and hold position while gliding iron over the covering to re-tension the structure. Repeat process until the panel is true.
- 1 Follow the same procedure with the other half of the wing.

## COVERING THE TAIL

Following the same procedure as with the wing, cover the stabilizer/elevator and the fin/rudder. After covering over the hinge holes, immediately go back and slit the covering to open the holes where the hinges will be installed.

### INSTALLING HINGES

- 1 Use your CG Hinge Marker to mark the center of the wood surfaces to be joined.
- 1 Carefully cut a slot approximately 1/2" deep and slightly wider than the hinge, using your favorite knife blade.
- 1 After all slots have been made, mark the center of your hinge and insert a pin (see illus.) This will hold the hinge in place while sliding the matching part (aileron, etc.) onto the JET HINGE.

### DO NOT GLUE!

- 1 With both surfaces hinged and assembled, check the alignment. For good control response, the hinge gap should be as small as possible, but should allow for full deflection when needed.
- 1 When all the parts are ready for hinging then remount the hinge with a pin inserted in the center, when satisfied that all parts are aligned properly, remove pin. Apply 3 to 4 drops of thin CA glue to the exposed hinge line. Turn over and apply another 3 to 4 drops to the hinge line of the other surface.
- 1 Allow 10 minutes for the CA to cure, before flexing the surface.
- 1 Work the surface up and down to remove any stiffness you may feel.

## COVERING THE FUSELAGE

For added realism, the cabin interior may be painted now. Use any of the paint materials recommended on the inside front cover of this book; even gray auto primer will do. Then proceed with covering the fuselage.

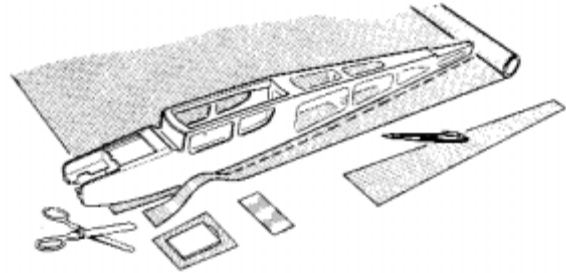

- 1 Mark and cut out covering pieces for the fuselage.

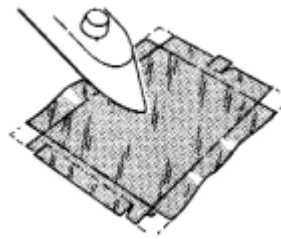

- 1 Apply covering to hatch top.
- 1 Cut corners and slit sides.

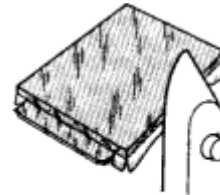

- 1 Wrap and seal covering around edges.



- 1 Trim and wrap covering around to hatch bottom.

- 1 Apply covering to the hatch top, as shown in the diagrams.



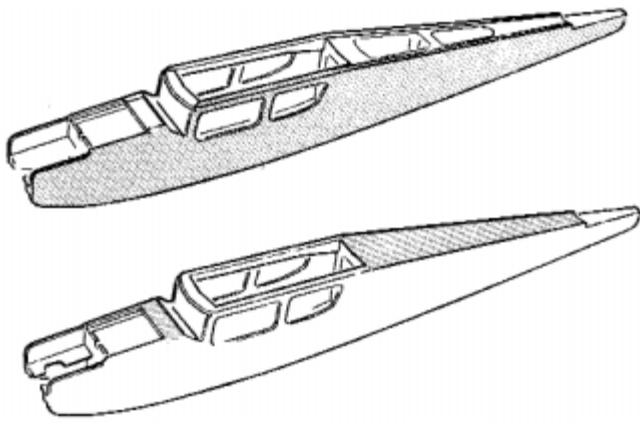

1} Apply covering first to the bottom and then to the sides of the fuse. Cover the top of the fuse last.

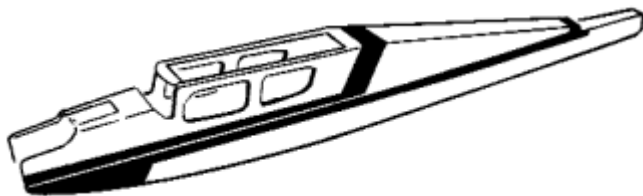

1} Finish by applying the trim color.



**HINT:** It is a good idea to apply a triple coat of covering to the tail end. To minimize abrasion damage, we highly recommend you apply a strip of CGM Scuff Guard.

## WINDSHIELD



Clean model surfaces thoroughly before applying decals. Cut decal sheets apart in sections, as needed. Fold decal in half, front to rear. Open at fold and lay decal out straight. The protective backing will bubble away from the decal at the fold. Using a scissors, cut the backing along the bubble, removing a strip of backing about 1" wide. Carefully position the decal on the model and stick in place. Then, working from the center, rub the decal down while peeling off the backing.

## WINDSHIELD

CAUTION: FOLLOW INSTRUCTIONS CAREFULLY

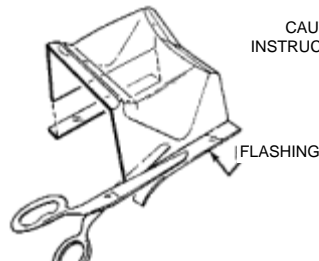

1) CAREFULLY REMOVE FLASHING AT BOTTOM OF WINDSHIELD SIDES.

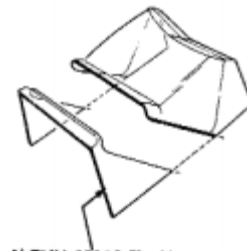

2) TRIM SCRAP FROM FRONT OF WINDSHIELD BY CUTTING ON MARKED LINE.

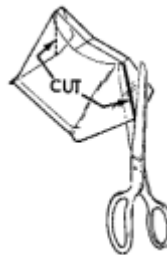

3) MAKE TWO VERTICAL CUTS AT MARKED LINES.

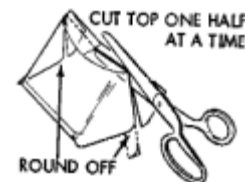

4) OPEN SACK SLIGHTLY, INSERT SCISSOR BLADE HALF WAY AND CUT ON LINE. REMOVE SCISSORS AND FINISH CUT FROM OTHER SIDE. ROUND OFF BOTTOM CORNER OF WIND SHIELD AT MASKED LINES.

1} Remove windshield from vac-formed sheet by cutting on lines as shown in sketches

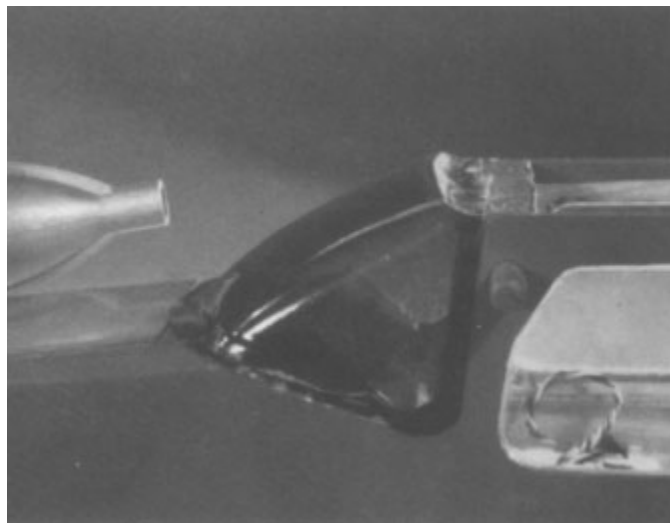

1} Temporarily set windshield in place on fuse and note where its outline contacts fuse. For better gluing, lightly sand covering in this outline area, just dulling covering surface. Also, for added gluing strength, make a series of pin hole punctures through the covering, so glue can grab the wood underneath.

- Glue windshield in place, taking care to keep glue only on the edge of the plastic. After the SUPER JET has dried, a trace of white film may appear inside the windshield. Wipe off with a damp cloth.

Optional: Improve the appearance and strength by applying a strip of UltraStripe to the joint between the fuse and the windshield.

- Insert the 5/16" wing hold-down dowels through the cabin with a twisting motion. Dowels should protrude an equal distance from sides of cabin. Glue in place.
- Using fuel-proof paint, seal exposed ends of the wing dowels and any other unprotected wood surfaces.

## SIDE WINDOWS

WINDOW GLUING FLANGE (SHOWN SHADED)

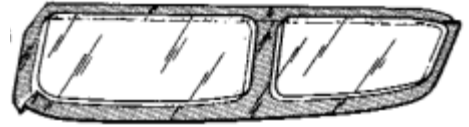

- Lightly sand window-gluing flange, in order to promote a good bond to fuse. Avoid scratching windows. Permanently glue windows in place on the fuselage.

## FINAL ASSEMBLY

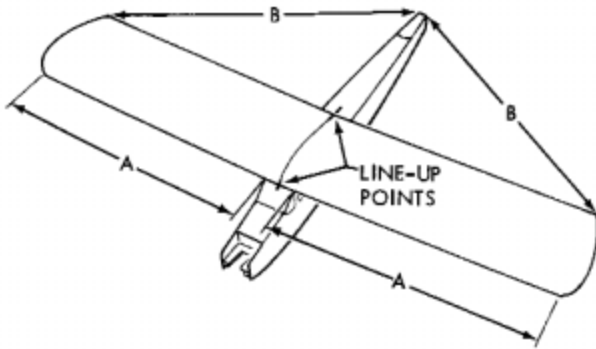

- The top edge around the cabin area should be lined all around with 1/16" x 1/4" self-adhesive foam wing seating tape. When the wing is in place, the tape seals against entry of exhaust oil and dirt into the radio compartment. Also, the tape is a cushion between wing and fuse to prevent abrasion of the covering.

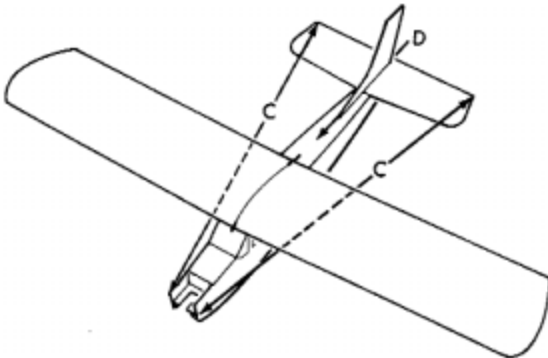

- Mount wing on the fuse using rubber bands. Measure carefully from the fuselage sides out to the wing tips (arrows 'A') to be sure that the wing is centered. Then measure from the wing tips to the back end of the fuse (arrows 'B') to make sure wing is square with fuse. Mark the wing center at leading and trailing edges, and the fuse, with matching line-up points. Color-Stripe tape can be used for this, or certain marking pens.
- Using no glue, trial fit stab in place on fuse, marking it for center, and adjust as necessary to line up with wing. Then measure from the stab tips to the fuse front (arrows 'C') to make sure stab is square with fuse. Mark match-up lines on fuse and stab for alignment.

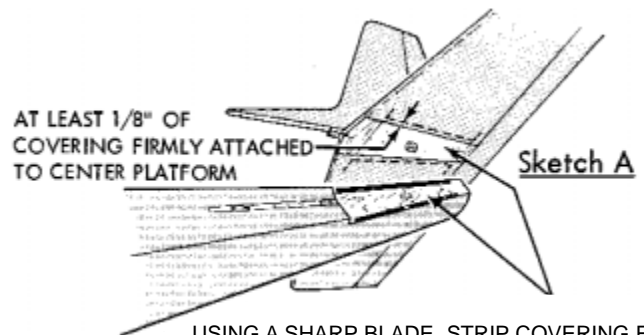

USING A SHARP BLADE, STRIP COVERING FROM STAB, FIN, & FUSE WHERE THEY MATE, FOR WOOD TO WOOD GLUE JOINT. LEAVE 1/8" TO 3/16" OF COVERING FIRMLY ATTACHED TO CENTER PLATFORM. CAUTION: WHEN TRIMMING COVERING, AVOID CUTTING INTO WOOD STRUCTURE UNDERNEATH.

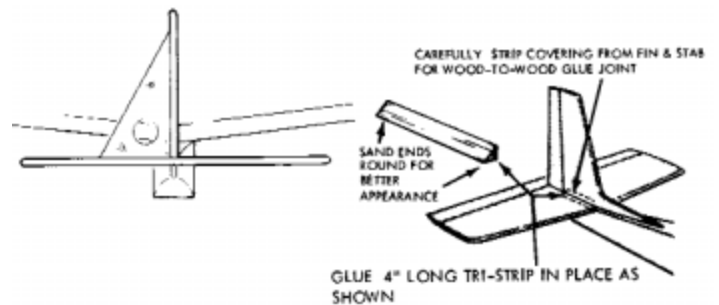

- Glue 5/16" triangle stock on side of the tin.
- To provide a firm wood-to-wood glue joint, strip covering from bottom of stab center where stab contacts fuse (see sketch A) avoid cutting structure underneath. Be certain to leave enough covering firmly bonded to stab center (minimum 1/8" to 3/16"). Likewise, if slab area on fuse was covered, remove covering. Glue stab firmly to fuse and let dry.
- Trial fit fin in place on fuse/stab (arrow 'D'). Strip covering from fin bottom (if covered) and respective area on fuse/stab. Glue fin firmly in place, and square with stab. Let dry.

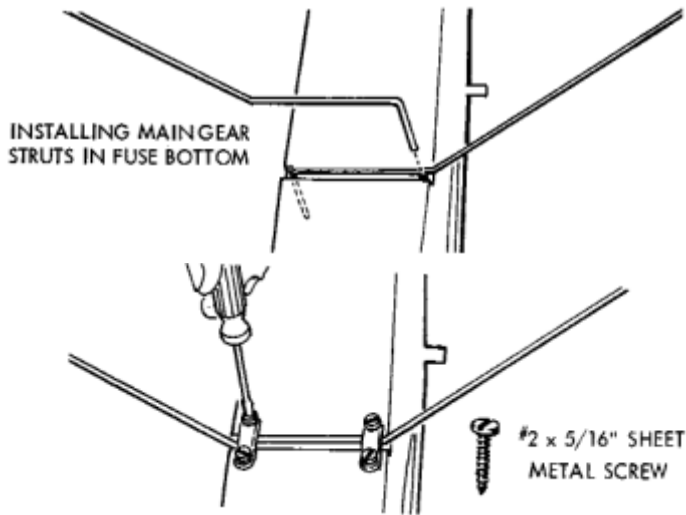

- 1 Insert formed wire main gear struts in fuselage. Position nylon landing gear straps; then mark, drill, and mount with #2 x 5/16" screws (see sketches above and illustration on page 10).

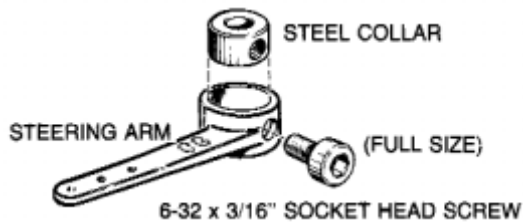

- 1 Press one of the four steel collars into the pocket in the nylon steering arm (side holes must be aligned). Thread #6-32 x 3/16" socket head screw in a few turns.

- 1 Install nose gear strut in bearing and steering arm (refer to illustration on page 10). Tighten socket head screw with Allen wrench.

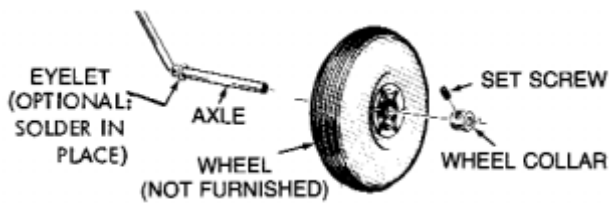

- 1 Install wheels on axles as shown: eyelet first, wheel, then wheel collar and set screw.

## FUEL SYSTEM

- 1 Assemble your fuel tank per manufacturer's instructions.
- 1 Refer to full size views on plan, and install fuel tank and lines. Support bottom of tank with foam rubber.
- 1 Attach the fuel line (leading from the "clunk" weight inside the tank) to your engine's carburetor. This is also the line to use for fueling. You simply slip the line off the engine, fill the tank, and re-connect line to engine.

## OPTIONAL PRESSURE FEED

- 1 If your muffler has a fuel-line type fitting on it, you can use it to "pressure feed" fuel to the engine for smoother and more reliable running. In this case, the vent line is connected to the muffler fitting.

## TREAT YOUR RADIO RIGHT - AND IT WILL DO THE SAME FOR YOU!

by Hal deBolt Famous R/C Pioneer

Today's RC systems are very well engineered and constructed. However, they will remain only as good as the way in which they are USED. Experience has shown us how to use them to perfection. Follow the proper rules religiously, and anyone can have success.

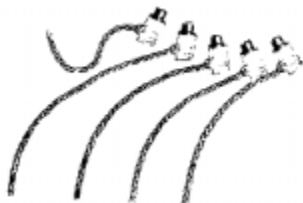

**CONNECTORS:** In using connectors, never pull on the wires to disconnect; grasp the plugs instead. Clean them by dunking in solvent; dope thinner is fine. Do tape the connectors together when installing, and be sure that there is no strain on the cables.



**RECEIVERS:** Receivers must be vibration free. Wrap them in a minimum of 1/2" soft foam rubber (not plastic foam) when installing. Keep clear of all cables and batteries. Tune annually as indicated below "Check-Ups."



**RECEIVER ANTENNA:** The receiver antenna must be routed directly out of the airplane and to the top of the fin, or preferably to the stabilizer tip. At no place should it be close to anything metal or electronic. Visualize it as being about 3" in diameter instead of 1/16". Do not allow anything other than wood or plastic to be within the 3" diameter.



**SERVOS:** Servos are vibration prone. Do mount them with grommet shock mounts in servo trays which are in turn shock mounted. Keep them clean. If a neutral position should drift, it is a sign of a change; find out WHY before flying again.

**TRANSMITTERS:** Keep your transmitter clean and free from fuel residue and dirt. Battery condition and RF output should be monitored, and the system should be aligned and tuned annually. Do not transport under vibration (floor of a car); place them on something soft.

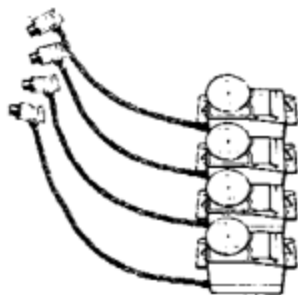

**PUSHRODS:** Obviously, pushrods should be installed freely so that they place no load on the servo. Using a servo's power to move a tight rod or heavy surface by force increases the battery drain, shortens the electronic life, and can cause neutralizing problems. While being free, the pushrod must not flex or vibrate. Any vibration is transferred directly to the servo, its gear, motor and pot. While maintaining freedom, flexing and vibration can be prevented by the use of guides and fairleads on the rods.

**CHECK-UPS:** When—at least once annually, and it should include the tuning and alignment of the system, plus TESTING the batteries. Also, any time anything unusual occurs during usage. A malfunction or "glitch" is the first sign of an impending failure; it should not be ignored. Where—at a factory authorized center that understands your particular equipment. If not available, an established center can offer advice.

**AND: ADD A SMALL PORTION OF GOOD LUCK.**

# RADIO PREPARATION & INSTALLATION

1. Before continuing, make sure each of the following items has been completed:

- ‡ Model is fully covered and painted wherever necessary.
- ‡ Control surfaces are hinged in place.
- ‡ Tail assembly is glued solidly to fuselage.
- ‡ Engine is fully installed, with spinner and prop in place.
- ‡ Muffler is installed.
- ‡ Fuel tank is installed, with foam rubber supports to hold it level.
- ‡ Stab and rudder pushrods are complete (rear end only).
- ‡ Landing gear and wheels are installed

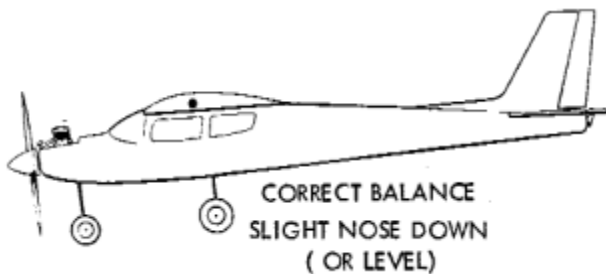
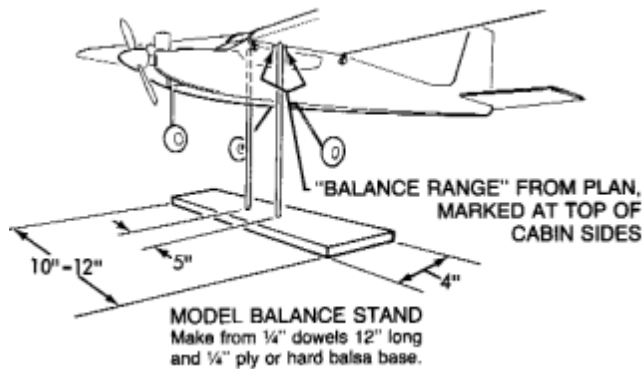

2. Balancing The Model.

- ‡ Tape stab and rudder pushrods to side of fuse with rear ends in approximate final position (refer to full size view on plan).

- ‡ Set RC airborne equipment temporarily in fuse (refer to plan for approximate location).
  - a) Battery most forward.
  - b) Receiver (Rx) next.
  - c) Servos rearmost.
  - d) For "A" or "B" wing, install aileron servo in wing.
- ‡ Refer to fuse side view on plan for "BALANCE RANGE," then measure and mark this range at top of cabin sides.
- ‡ Temporarily rubber band wing in place on top of fuse. When flying, use at least seven #64 rubber bands on each side.
- ‡ Lift the model under the wing near the fuse by finger tips. A better way is to use a simple set-up with a couple of 1/4" dowels with rounded tops, spaced 5" apart.
  - a) Move finger tips or balance stand through the balance range until model is level.
  - b) If you need to support the model outside the balance range to get it level, remove wing and shift R/C equipment away from heavy end of model until model will balance within the range. The preferred location is at the wing spar.
  - c) if shifting the R/C gear still doesn't balance the model, add weight to extreme nose or tail respectively until it's right. The least weight is needed when added as far forward or back as possible. Fasten weight permanently in place.
- ‡ Carefully remove the wing, and mark on fuse interior the locations of all R/C parts.



- ‡ Completing stab and rudder pushrods:
  - a) Measure about 2" from the backsides of the servos to the balsa pushrods, and mark them at this point.
  - b) Remove pushrods from fuse, and cut them at marks.
  - c) Cut one 1/16" x 12" wire in half, and use these pieces to complete forward end of pushrods.

### 3. Radio Installation.

- A. Read and follow the instructions that came with your radio.
  - B. If your batteries are dry cells, they should be fresh. If rechargeable nicads, they should be fully charged,
  - C. Hook-up Radio and Try Operation.
- 1 Refer to "Transmitter Function Sketch" below, and observe which servo wheels move when stick is moved for various controls.

YOUR TRANSMITTER (Tx) IS BUILT LIKE ONE OF THOSE SHOWN HERE. EACH SKETCH SHOWS HOW THE STICKS ARE MOVED TO CONTROL VARIOUS PARTS OF THE MODEL.

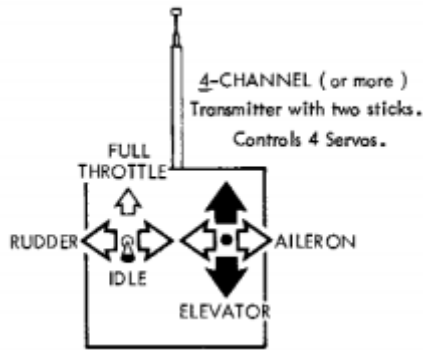

FOR "A" or "B" WING (With Ailerons)

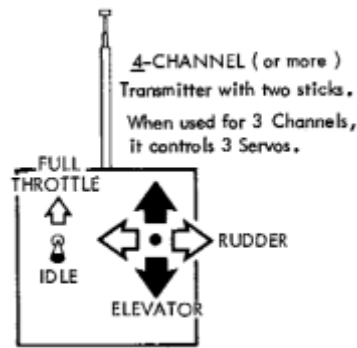

USED WITH "C" WING ONLY (Non-Aileron)

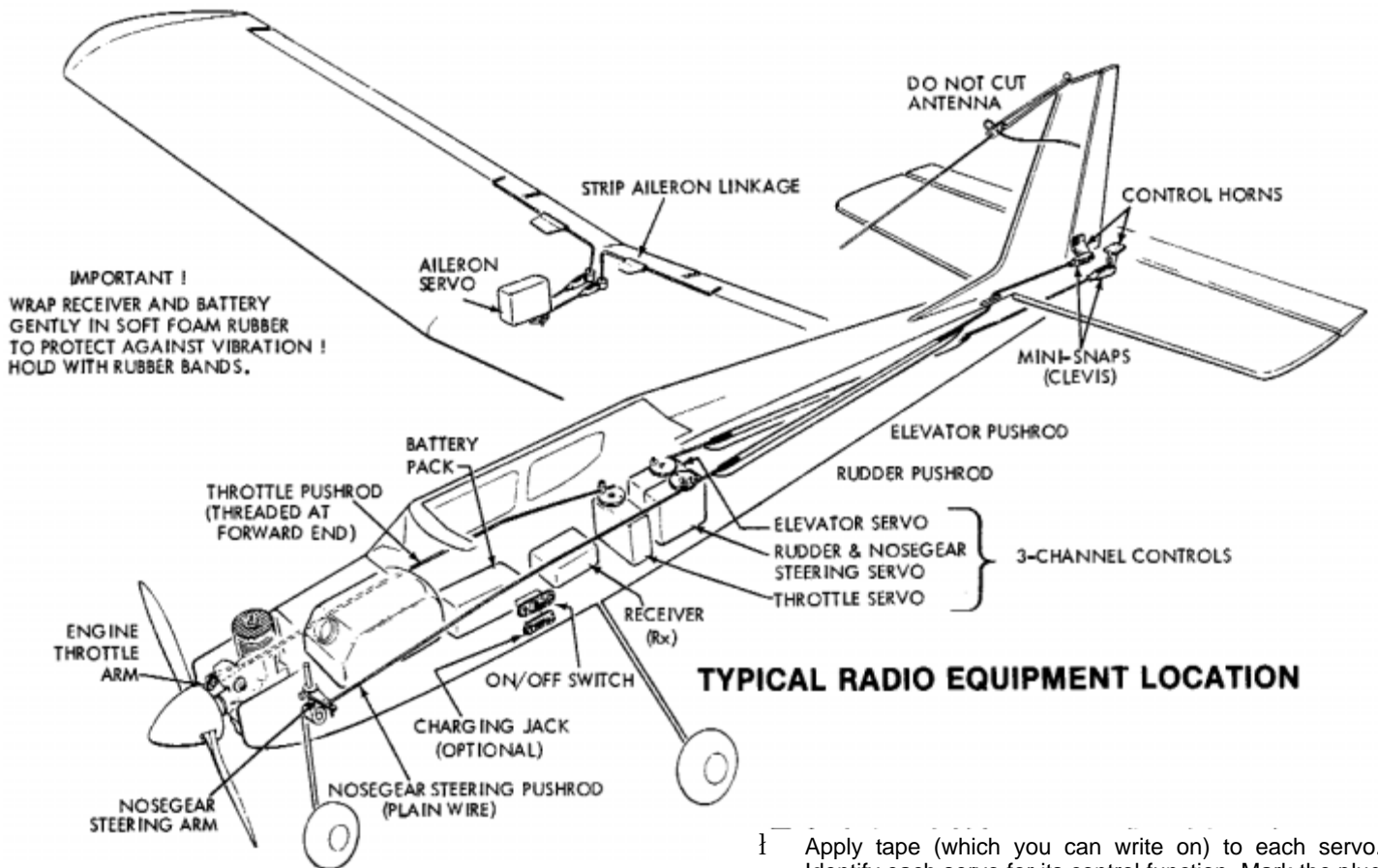
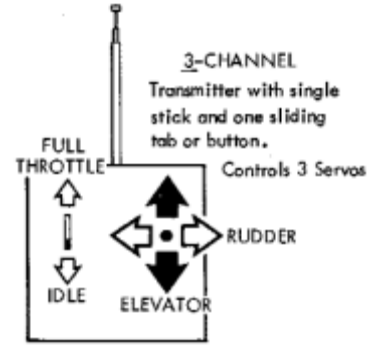

THE INSTALLATION ILLUSTRATED HERE IS A GUIDE: DEPENDING ON YOUR ENGINE AND R/C GEAR, YOU MAY NOT BE ABLE TO FOLLOW IT EXACTLY.

READ THE INSTRUCTIONS THAT CAME WITH YOUR RADIO THOROUGHLY BEFORE STARTING RADIO INSTALLATION.

- 1 Apply tape (which you can write on) to each servo. Identify each servo for its control function. Mark the plug to each servo the same way: "R" for rudder, "E" for elevator, "T" for throttle, "A" for ailerons if you have them. If your receiver doesn't have separate plugs for each servo, but places for the servos to plug in, apply a piece of tape nearby that you can mark for each application.

#### 4. Servo Arrangement.

"REVERSE" SERVO CAN BE IDENTIFIED BY A DOT IN MOUNTING FLANGE AS SHOWN HERE, OR A DIFFERENT COLOR CASE OR MARKINGS.

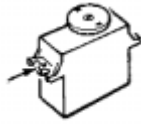

CONTROL MOVEMENTS ARE THE SAME AS IN A FULL-SIZE AIRPLANE

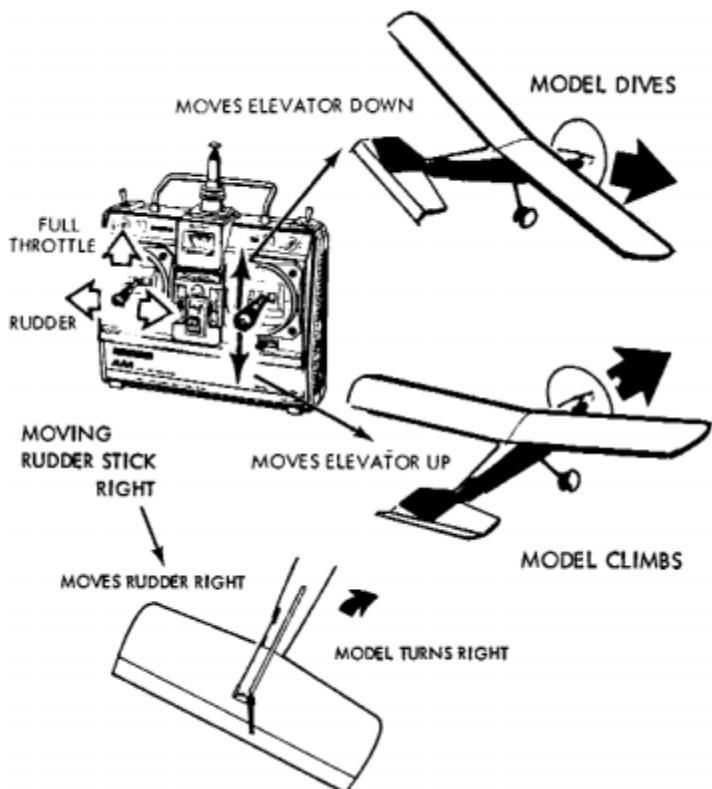
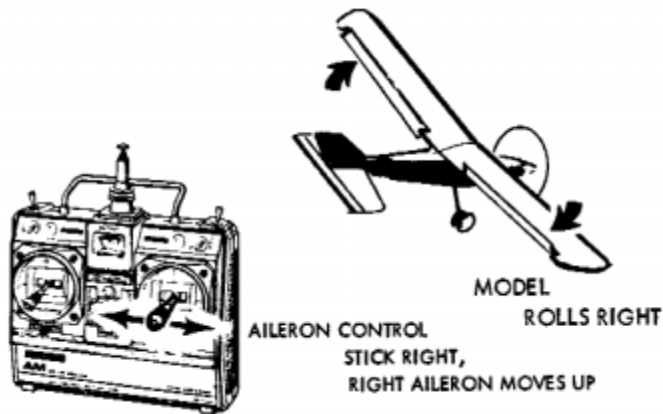

- 1 With throttle servo at forward position, place servo so output wheel is on same side as engine throttle arm.
- 1 Rudder servo should be on side opposite to throttle servo so it can drive the nosegear steering arm in a nearly straight line.

In radio sets without "servo reversing" feature, the rudder servo is usually a "reverse" servo. A "reverse" servo can be identified by a dot, or a different color case or markings.

- 1 Elevator servo occupies remaining rear position.

#### 5. Servo Movements

As mentioned in the introduction on page 2, radio systems with "servo reversing" simplify radio installation. With a regular non-reversing system, you must match each pushrod to its corresponding servo's rotation. With "servo reversing," pushrods can be hooked up to either side of the servo's output wheel, and after checking the control response, a servo responding in the wrong direction is easily switched to correct action (see your radio manufacturers instructions).

The 2+1 arrangement on the plan shows standard servo placement for a "servo reversible" system. For either type of radio system, check your equipment out with the following procedure.

- 1 Push the transmitter (Tx) throttle lever up away from you, and observe where throttle servo wheel should connect to the throttle pushrod to give full throttle, Mark this on the servo wheel (write on tape). Return throttle lever to full down (idle position).

- 1 Ailerons ("A" or "B" wing). Move the aileron stick to the right, and observe that the right aileron must be connected so it moves up.

- 1 Move the elevator stick up, and observe where the elevator pushrod must be attached to the elevator servo to pull the elevator down. Mark servo.

- 1 Move rudder stick to the right, and observe where rudder servo wheel should connect to give right rudder and nosegear steering. Mark this on the servo wheel.

Remember, for non-reversing radios, that the rudder servo usually needs to be a "reverse" servo.

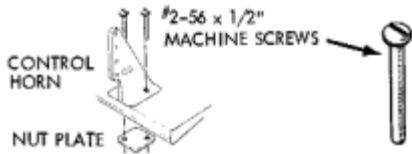

6. Mounting The Control Horns and Pushrods. Rudder Horn (Small):

- 1 Refer to fuse side view on plan for correct location.
- 1 Tack-cement small horn on correct side of rudder.

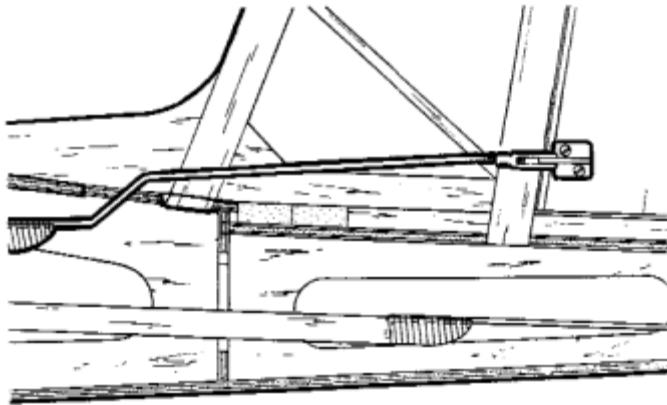

- 1 Drill through holes in horn, and mount nut plate on other side using screws as shown. Trim screws flush with nut plate.
- 1 Remove covering from die-cut hole in fuse top (adjacent to dorsal fin) for rudder pushrod.
- 1 Lay pushrod over pushrod views on plan, and make bends as required. Working from cabin, feed rudder pushrod (threaded end) through fuse rear and out exit hole. Use a loop of string or wire to pull threaded end up through exit hole.



- 1 Twist mini-snap (clevis) onto threaded rod, Hold pushrod wire with pliers while installing mini-snap. Connect to rudder horn.

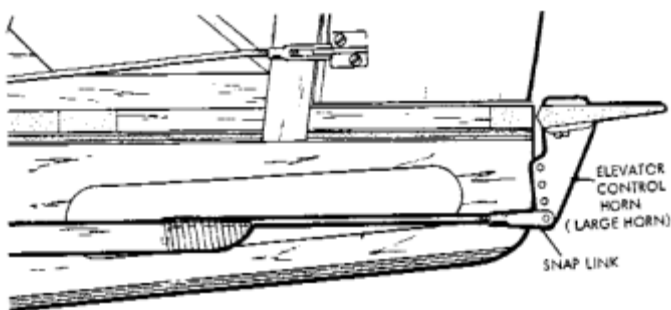

ELEVATOR HORN (Large):

- 1 Insert threaded end of elevator pushrod from cabin through fuse rear and out slot opening about 2".
- 1 Install mini-snap on rod, and connect to elevator horn.
- 1 Position horn under elevator — refer to plan for correct location, When horn is centered so mini-snap moves in and out of tail opening without scraping sides, mount horn on elevator.



## 7. Mounting Servos

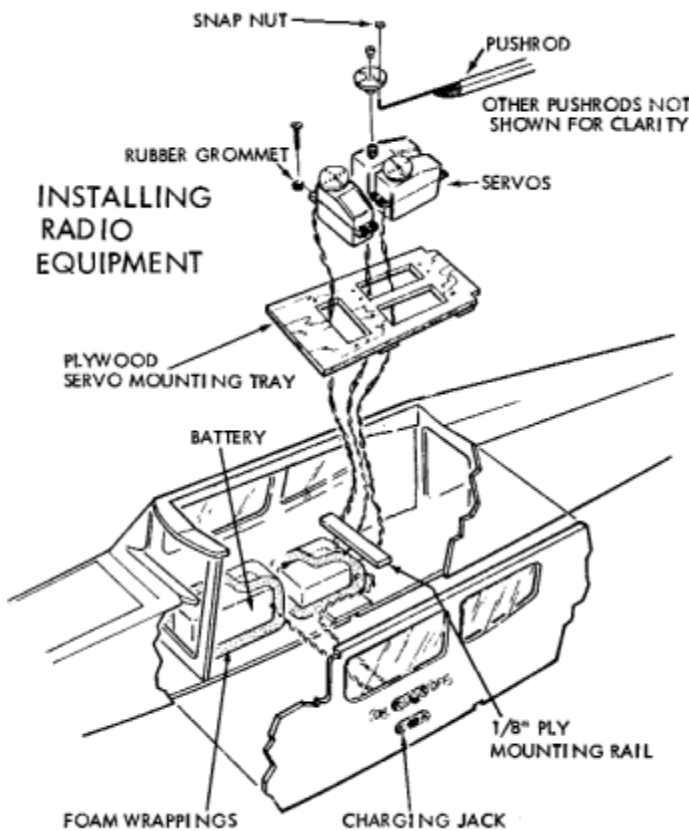
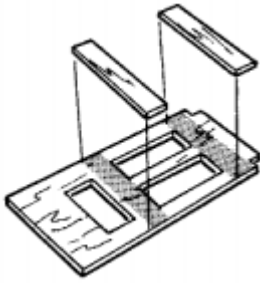

- 1 Tape front end of rudder and elevator push rods up out of the way under cabin top doublers.
- 1 Glue two ply braces to bottom of ply servo tray as shown.
- 1 Insert the soft rubber gram mete into the mounting holes of your servos and tray.
- 1 Correctly position servos in tray, Mark through the grommets for the location of the mounting screws. Remove the servos. With a 1/16" drill bit, drill holes in tray.
- 1 Reinstall servos and gently fasten them in place with screws provided with your radio system (or with #2 x 3/8" sheet metal screws).
- 1 Engage tab at rear of servo tray into matching side notches in former "C".
- 1 Position 7/16" x 3-9/16" ply mounting rail under front of servo tray so rail is about 1-1/2" above fuse floor. If the rail is too long to fit inside fuse, sand one end until it fits snug. Glue rail to fuse sides.
- 1 Glue servo tray to rail and former "C".

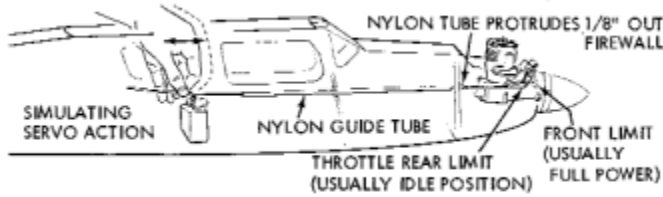

8. Installing The Throttle Pushrod.

- 1 } Screw mini-snap on the extra-long remaining threaded rod.
- 1 } Carefully bend rod to fit curve of throttle pushrod as shown in fuse top view on plan.
- 1 } Cut a 10½" throttle pushrod guide tube from long nylon tube (remainder is steering pushrod guide tube).
- 1 } Starting at hole in firewall, slide throttle guide tube into fuse and through upper side slot in former B, Nylon guide tube should protrude 1/8" out firewall as shown in sketch below, Slide rod through guide tube and connect mini-snap to engine throttle arm.
- 1 } At rear end, make sure bend in wire leads it towards throttle servo wheel as shown on plan.

Move pushrod back and forth to simulate servo action. The pushrod should move freely; if not, adjust wire where necessary. Feel the front and rear "limits" of the throttle arm. Later, when setting controls, be sure to set the throttle servo linkage within the range of throttle arm movement, Glue guide tube to firewall, former B and fuse side. If the guide tube needs support, make a "stand-off" from 1/4" scrap balsa (see plan), Tailor the stand-off to suit the curvature of your installation, glue it only as required so it doesn't interfere with pushrod sliding action.

- 1 } Remove servo wheel, and install the CG Pushrod Connector as shown. This device lets you easily adjust throttle pushrod movement. Remount servo wheel.



Make sure throttle servo is at idle position. Engine throttle arm also should be at rear or idle position. Align and cut the pushrod wire so it extends 1/4" to the rear of the pushrod connector, and attach. Check action with radio, and if OK, throttle pushrod hookup is completed.

9. Installing The Nosegear Steering Pushrod.

- 1 } Make a square bend down 1/4" from one end of 1/16" x 16-3/4" wire, and a slight upward bend 1" further back as shown on plan side view. Slide steering guide tube over wire, and insert unbent end of wire through hole in firewall, lower side slot in former B, and back towards the rudder servo. Slip bent end into outermost hole in steering arm. Guide tube should remain about 3/4" behind firewall.
- 1 } Bend the wire towards proper hole in rudder servo wheel but DO NOT CUT YET! Move pushrod to check for free movement; correct as necessary. Glue guide tube to former B and fuse side.
- 1 } With nosewheel pointing dead straight ahead, the end of the steering arm should be 1/4" - 5/16" away from the firewall. Back at the servo, allow additional 3/8" past servo wheel hole, and cut it there. Bend cut end up 1/4".
- 1 } Roughen 1/4" bent end with sandpaper for better grip of snap-nut. Remove servo wheel to insert pushrod, add snap-nut, and then remount. Check action with radio. This completes the nosegear pushrod hookup, Later, during taxi tests, you can adjust nose wheel steering by loosening steering arm socket head screw.



10a. Hooking Up Elevator and Rudder Pushrods.

- 1 } Position elevator pushrod so that the T.E. elevator is centered with stab, Allow additional 5/16" past servo wheel hole, then cut and bend forward end of pushrod, Roughen bend-up wire with sandpaper, remove servo wheel and insert wire, and retain with snap-nut.
- 1 } Position rudder pushrod so that the rudder is aligned with fin. Cut and bend forward end of pushrod as above, and attach to rudder servo wheel.

## 10b. Hooking Up Aileron Pushrods ("A" or "B" Wing Only).

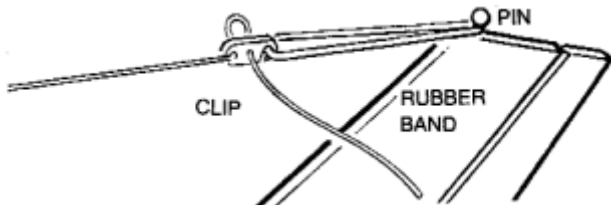
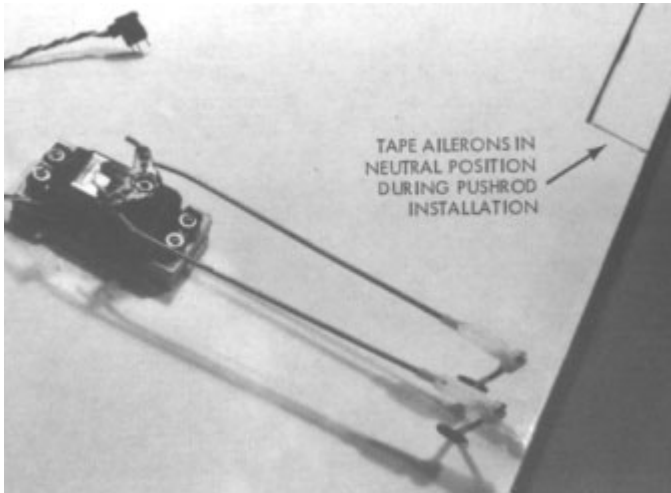
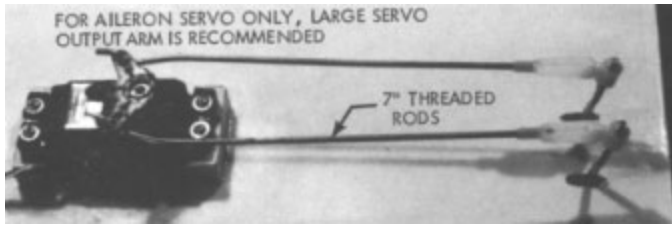

- 1. Re-install aileron servo in wing. Tape ailerons in neutral position (so flat bottom of wing and ailerons are flush).
- 2. Install horn brackets on aileron horns as shown. Install mini-snaps on each 7" True 1/16" threaded rod, then connect mini-snaps to horn brackets. Align each rod to its respective hole in-servo wheel. Allow additional 5/16" past servo wheel holes, then cut and bend forward end of pushrods, same as elevator pushrod procedure.

### 11. Installing Switch and Charging Jack.

- 1. Temporarily set battery and Rx in fuse. Position switch and charging jack cover plates on outside of fuse on side opposite to engine exhaust, and where they will not obstruct the battery or Rx, Mark through cover plates (or holes and openings. Remove battery and Rx.
- 2. Make holes through fuse side. Make sure hole for switch button is long enough for it to move to ON and OFF positions.
- 3. Install switch and jack.
- 4. Later, when radio is operating, identify ON and OFF positions with decals provided. Preferred "ON" position is forward.

### 12. Battery Pack.

- 1. You must have fully charged nicads or fresh dry cells for flying.
- 2. Wrap battery in 1/2" very soft foam rubber to cushion it from vibration and shock. Use rubber bands or tape to hold the foam around the battery. It is also good to place battery and Rx in individual plastic bags to protect against fuel and oil.
- 3. Position battery in fuse, and hold in place with additional foam rubber

### 13. Receiver (Rx).

- 1. Do not cut the antenna wire attached to the Rx.
- 2. Wrap Rx carefully in foam like the battery.
- 3. Re-connect all cables so R/C system is operational; be sure that each servo is plugged into its respective Rx terminal.
- 4. Place Rx in fuse behind the battery.
- 5. Lead the antenna wire up and back along cabin top doubler and out top rear of cabin. Tape wire inside cabin.
- 6. Using clip supplied with radio, suspend antenna from top of fin as shown above. Adjust antenna in clip so it is just slightly taut, not tight. Let excess wire hang loose from clip.
- 7. Gather all excess cables together behind Rx, and hold them down with foam.
- 8. Apply "ON/OFF" decals to outside of fuse to identify switch positions.

All pushrods must move freely, without binding; adjust if required for smooth operation. When setting control travel, be cautious that no servo is hooked to a control in a manner that prevents the servo wheel from moving through its complete range of rotation, For example, if the throttle servo "buzzes" when moved to "full-throttle" position, the servo still has movement left, but is jammed against the engine's full-throttle limit position, This can damage the servo and drain the battery, leading to loss of control, and a crash.

## 14. Setting Control Surfaces.

All pushrods must move freely, without binding; adjust if required for smooth operation. When setting control travel, be cautious that no servo is hooked to a control in a manner that prevents the servo wheel from moving through its complete range of rotation. For example, if the throttle servo "buzzes" when moved to "full-throttle" position, the servo still has movement left, but is jammed against the engine's full-throttle limit position. This can damage the servo and drain the battery, leading to loss of control, and a crash.

- 1. Move throttle lever on Tx to cycle the throttle from idle

The following instructions describe how to set the control surfaces measuring up and down movement using the angle templates provided. For first flights, it is recommended that you set controls per the angle templates for "softer" control response. Later, after you are more familiar with the airplane, you can always increase the throws as you prefer.

- 1. With elevator trim tab on Tx set in center, adjust elevator Mini-Snap until elevator TE. is centered with stab as shown.
- 2. Move the elevator stick on Tx full up and down. The elevator should move to match template angles, up and down.
- 3. With rudder trim tab on Tx set in center, adjust Mini-Snap until rudder TE. is centered with fin. Nose wheel should point straight ahead.
- 4. Move the rudder stick on Tx full right and left. The rudder should move to match the rudder template angle, left & right. The nose-wheel should move only very slightly as it doesn't take much to steer on the ground.
- 5. With aileron trim tab on Tx set in center, adjust and connect mini-snaps until ailerons are neutral with wing. Move the aileron stick full right and left. The ailerons should move respectively up and down to match aileron template.

### CUT GAUGES FROM PLAN

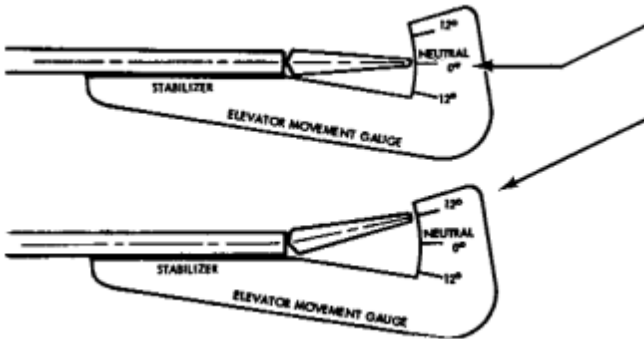
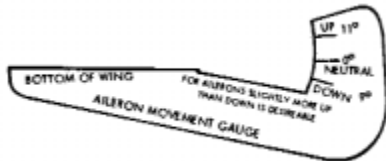
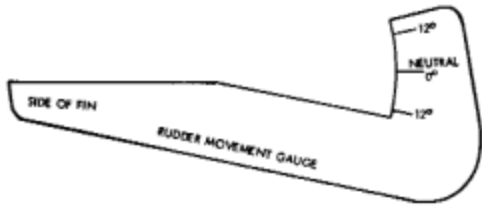

THIS COMPLETES THE RADIO INSTALLATION

## PILOT INSTALLATION

By special arrangement with Williams Brothers, a pilot figure is included with your kit. When installed, it adds a final touch of realism. The next few steps show how to assemble and mount this pilot in your model. Also, the pilot platform holds the battery and receiver in place.

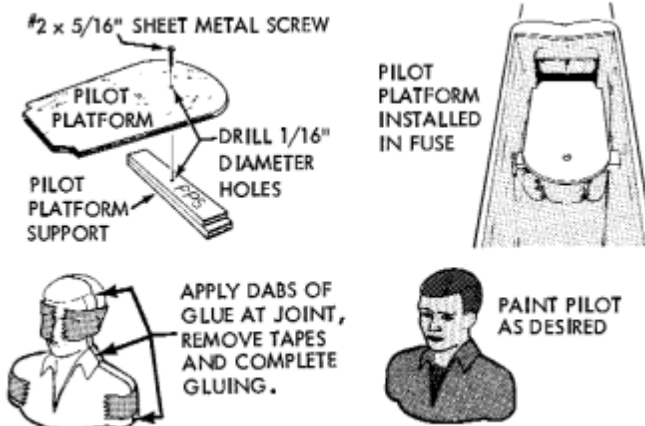

1. 1. Cut 1/4" off one end of one 1/8" ply pilot platform support (PPS). Then glue two of them together as shown.
2. 1. Drill 1/16" diameter holes through pilot platform and PS at marked locations.
2. 2. Using a #2 x 5/16" sheet metal screw, join platform to support.
3. 1. Fit platform assembly inside cabin, engaging platform front with notches in sides of former B, Adjust platform rear so it is about horizontal. Carefully sand off end of PS if necessary for good fit. Glue PS firmly to fuse sides. Parts may be painted to match fuse interior.
3. 2. Cut pilot halves apart at bottom, and trim off scrap. Rub each half gently over fine sandpaper to smooth edges for joining. Carefully align front and back and hold together with tape. Apply dabs of glue at joint, remove tapes and complete gluing.
4. 1. Paint pilot figure as desired, flesh, hair and jacket colors are your choice. Artist's acrylics and modeler's enamel paints are available in many colors — no mixing required. Warning: do not use lacquer based paints — they will destroy the plastic. When painting face, leave eyes white, then later carefully add eye details with a fine brush or toothpick. When dry, glue pilot in place on platform.

## SETTING UP YOUR ENGINE

Do not attempt to fly your model until the engine runs dependably. It should idle without stopping and the transition through all engine speeds should be smooth.

**WARNING!** The turning propeller can cause serious injury, such as deep cuts. Never reach across the propeller! Avoid wearing loose clothing (such as neckties) or jewelry which could fall into the spinning propeller. Small children should not be allowed near a running engine for these reasons. No one (including spectators) should stand in line with the propeller—a broken propeller blade becomes a bullet and could seriously hurt someone.

There are four basic adjustments to make your engine run well. Compare your engine's carburetor to the sketch at left and locate the four parts below.

### TYPICAL MODEL ENGINE CARBURETOR

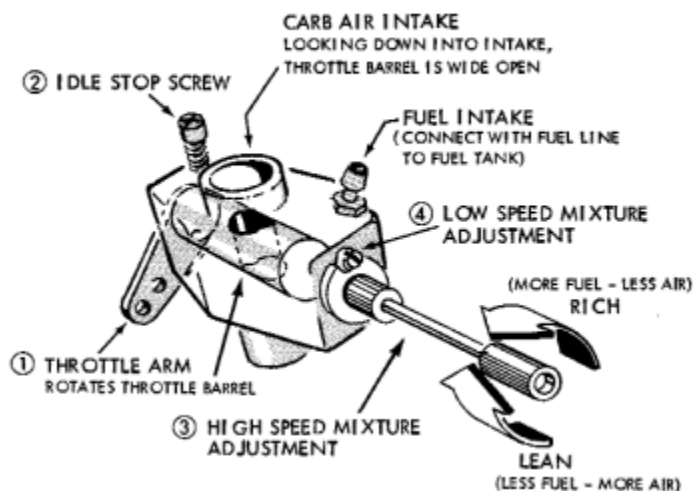

1. Throttle "barrel" opening. The rotating cylinder inside the carburetor is called the throttle "barrel". It has a hole in the middle to admit air. By rotating the barrel, the throttle can be "wide open" or completely "closed." This controls engine speed.
2. Idle Low-Speed Stop-Screw. This screw allows you to set how much the barrel can close for idle (to fully closed-engine stop).
3. High Speed Mixture (also called the Needle Valve) controls the mixture of fuel & air at high engine speeds.
4. Low Speed Mixture (controls fuel/air mixture at Idle speeds)

Now that you know where these parts are, let's make the adjustments one-at-a-time. There are four basic steps to make your engine run well.

#### SETTING THROTTLE (engine not running).

Start with transmitter throttle stick full open and trim full high. Then move throttle stick full low (with trim high) 1/8" throttle opening should show. Moving trim full down should fully close the barrel. If any adjustment is needed for proper range of throttle movement, determine best combination of hole positions for the servo wheel and throttle arm.

#### ADJUST IDLE/CUT OFF.

We recommend you adjust idle stop screw to just allow throttle to fully close, this will allow you to shut off the engine on command when throttle trim is moved full down.

#### HIGH SPEED MIXTURE ADJUSTMENT.

Temperature, humidity, fuel blend, etc. are variables that effect mixture. You should always start adjusting by setting high speed needle valve first, approximately three turns, then go back to idle. Adjust gradually, going back and forth until a good general setting is made. Once an engine is properly set, you should not have to touch the carb except for a click or two on high speed (needle valve) fine tuning.

## FIRST START ENGINE.

To start engine, first open 1/8 to 1/4 throttle. Prime with 4-6 drops of fuel in carb, attach glow plug and flip prop counter-clockwise to start. Or use an electric starter that will spin the prop.

## WHEN ENGINE FIRES.

—If it speeds up and dies it is too lean. Turn high speed (needle valve) 1/2 turn out (add more fuel).

—If it sputters, spitting raw fuel out the exhaust and dies—it's too rich. Turn high speed needle valve 1/2 turn in (reduce fuel).

Continue to adjust until it will run continuously (it should run on the rich side).

Hint: if you pinch the fuel supply line shut, the engine RPM should increase slightly before it dies—this is the correct High Speed Needle setting.

Now slowly open the throttle fully and again adjust needle valve not to peak power but a bit less on the rich side. High speed is set.

## SLOW SPEED MIXTURE ADJUSTMENT

Now reduce engine throttle to idle speed. If it will idle, wait for 10 seconds and hit full throttle.

—If it speeds up very quick and dies-it's too lean.

—If it sputters, hesitates and dies-it is too rich.

Your final idle adjustment should be a bit on the lean side to give the best transition. Once set it may never be adjusted again.

If engine will not run at idle, open throttle up to 1/3rd and try to determine if it's rich (sputtering) or lean (dies quickly) and adjust slow speed screw. Then slow engine lower and re-adjust, if necessary. A good sport 2-cycle should idle 2,500 RPM easily. Some engines will go to 2,000 but that's very low.

GENERAL. Do not fly your plane until engine is set up properly. As engine "breaks-in," both idle and power will improve. Bad idle can be caused by dirt, bad fuel, or a bad glo-plug. Hint; if at idle the engine dies when you remove battery power from plug, it's probably too rich or a bad plug.

# IMPORTANT

**TAKE THE TIME TO PROPERLY BALANCE YOUR MODEL AS SHOWN HERE!  
THIS INFORMATION APPLIES TO ALL AIRPLANES**

Don't be afraid to add whatever weight is necessary to balance your plane according to your needs.

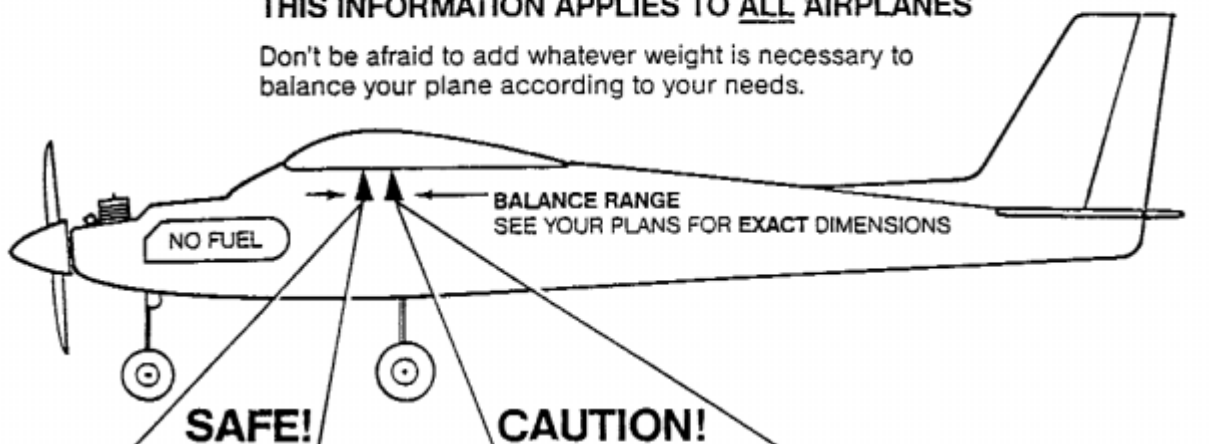

**SAFE!** Use the most forward balance point recommended for the first flights of any new model, and for flight training. Balanced here the model will be "easier" to fly.

**CAUTION!** Use the most rearward balance point for those experienced in sport and aerobatic flying. The model will be more responsive to elevator control. As balance is moved rearward, more pilot skill will be required.

**WARNING!** If you try to fly a plane with the balance point further behind the rear of the recommended range, you run the risk of having an unstable aircraft and there will be a stranger likelihood of crashing.

## WHERE TO FLY

Fly only in areas sanctioned for R/C and known to be free of radio interference. Ask your hobby dealer or other modelers if there is an R/C flying field that is used by a local R/C club. This is the ideal place to fly. If you don't know of an R/C club nearby, contact the Academy of Model Aeronautics (AMA), at the address on the front of this booklet, for information on a club in your area. Remember: R/C flying fields need to have rules to help prevent accidents, so ask about them before you turn on any of your equipment! DO NOT TEST your transmitter in the parking lot or anywhere nearby until you are sure no one else is using your radio frequency. This could cause another flyer to crash and make you very unpopular!

If there is no club or other R/C flying site available, locate a square area (preferably a grassy field), at least four or five football fields long, which is free of power lines, trees, poles, houses, busy streets and other obstructions. It must be at least three miles away from any areas where other R/C models, such as boats or cars, are operated. It should also have a relatively smooth surface, as it will take practice to learn precision landings. If you find a suitable location, turn your receiver on for 2 or 3 minutes to check that no one in the vicinity is operating an R/C device which could affect your receiver and cause your plane to crash.

## LEARNING TO FLY

Your chances of success are enormously increased if you have an instructor. Learning to fly is harder than it looks, and a mistake can seriously damage or destroy your model. Even full-scale pilots have problems learning to fly models because it's different—they're not in the cockpit. It's worth real effort to find someone to teach you. Many clubs have authorized instructors and there are even some R/C flight schools. Ask your dealer, or even check on the internet to see if there is someone who can help. Only if there is no other way should you attempt to learn on your own.

## CHECK YOUR EQUIPMENT!

Prior to going to the flying field, with radio batteries fully charged, turn on both receiver (Rx) and transmitter (Tx) and actuate all controls many times until you are satisfied with all functions.

Before beginning each day's flying, make a range check of your equipment in accordance with the manufacturer's instructions, in general, with transmitter antenna collapsed to 6"-8", you should have an at least 100 foot range on the ground. To check this, turn on both the transmitter and the receiver switches, set the model heading away from you, and walk away while transmitting signals. Watch to see that no signals are missed until you are at least 100 feet away. Only if the equipment works perfectly should any flights be attempted. Again, be careful to not use your transmitter when anyone else at the field is flying or testing on the same frequency!

After the range check, stand behind the model and make sure the control responses are correct. Moving the control stick to the right should give right rudder (on a 3-channel setup) or the right aileron should go up (on a 4-channel setup). Moving the stick back or down on the Tx should move the elevator up, and vice versa.

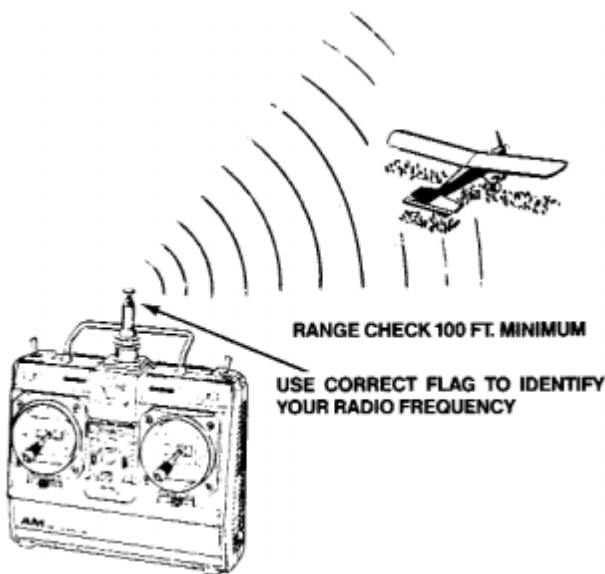

## PRE-FLIGHT CHECK LIST, THINGS TO DO, AND THINGS TO TAKE TO THE FIELD

- ! Flight batteries fresh or fully charged
- ! Radio transmitter (DON'T LEAVE IT AT HOME!)
- ! Fresh 1-1/2 volt starting battery & Glo plug clip
- ! Tools to tighten anything that can vibrate loose
- ! Fuel and fuel bulb or pump    ! Extra props
- ! Paper toweling (for clean up)    ! Prop wrench
- ! Extra #64 rubber bands    ! SUPER JET



Check also to see that your nose wheel turns to the right when you give right rudder. Your throttle should open to permit full power when the stick or tab is moved forward or up. Make sure that everything is neatly and firmly in place—engine fastened down, servos snugged down, receiver and battery wrapped in foam rubber, tank properly supported, etc. Prop and spinner must be tight. Nothing should be loose, or unfinished, or unchecked. Receiver antenna must be extended, not coiled up inside the model.

With everything ready, the engine should be started and broken in for at least a tank or two at no more than moderate speed. While the engine is running, the control surfaces should not jitter or move until you command them. The throttle also should respond to your command.

**PRACTICE STEERING THE MODEL ON THE GROUND**

For the next couple of hours, practice taxiing the model around at low speed. This is a very helpful step in making you feel more at ease in controlling the model. Do not rush it. Use a parking lot rather than a street where you are likely to run into a curb and damage your model. Practice taxiing in light breezes or when the air is calm; strong or gusty winds can catch a wing and flip your plane over.

It is very important in flying to make all your control movements slow and measured. Rapid movements tend to throw the model out of control. Apply minimum throttle so that it just keeps the model moving at a walking pace. With rudder stick and rudder trim in neutral position, the model should move straight ahead, if it constantly turns left or right, the nose wheel is not pointing straight ahead, and should be adjusted until it is correct. Adjust the nose wheel only, loosening the steering arm to do so.

Do a lot of practicing with the model coming towards you, as it often will in the sky. When the plane is pointing at you, the steering will appear "reversed." When you give right rudder, the plane turns to your left—but the model actually is turning to its right as you commanded. With practice, you will soon overcome this. When the model comes towards you, simply push the stick left or right towards whichever way the ship is turning. Another helpful technique is shown in sketch A.

Sketch A

WHILE LEARNING TO FLY, YOU MAY FEEL BETTER ABLE TO CONTROL THE MODEL, AS IT COMES TOWARD YOU, BY LOOKING OVER YOUR SHOULDER AND FACING YOUR BODY IN THE SAME DIRECTION AS THE MODEL IS FLYING.



"Head-on" disorientation is a nuisance on the ground, but dangerous in the air where things can happen pretty fast. The more familiar you become with the behavior of the model as you control it on the ground, the better prepared you will be for flying.

GENTLE TURN



STEEP TURN



After taxi runs are completed, thoroughly examine the model, and tighten loose screws, etc. First flights should be made on a day that is not very windy or gusty. There should be very few people or other distractions around. You will need to concentrate. Your success doesn't depend on following the instructions here to perfection, but you should have a flight sequence in mind. Think ahead of the model—don't chase it around the sky always one thought and one control command behind it. Your first flights should last no more than 2 or 3 minutes.



TRY TO KEEP TURNS GENTLE, STEEP TURNS SHOULD BE AVOIDED

**TURNS**

Try to make all turns gentle, not tilting (banking) the wings very much. If you increase the bank (making the turn steeper) there will be a corresponding weight increase and reduction of lift. Therefore, when you bank your plane it will start to descend. To maintain altitude in a turn you will have to add enough back stick (up elevator) to hold the nose "up" through the turn.



# FIRST FLIGHTS

## INTRODUCTION

There is no way to fully explain the principals of flight and the techniques of flying in only a few pages. Entire books have been written about apparently simple subjects as the shape of the wing. And even if you read several books about flying techniques, there is no substitute for an experienced R/C flyer helping you learn to actually fly. The following information is not intended to replace your flight instructor but we hope it will help you understand basic flight concepts and techniques.

One of the most important yet sometimes neglected pre-flight checks is to always make sure the wing is securely banded to the fuse! Use at least seven #64 rubber bands on each side of the wing. The first flight instructions below show the essential flight elements. If you have a helper, acquaint him with these steps, and have him call each of them off to you at the appropriate time.

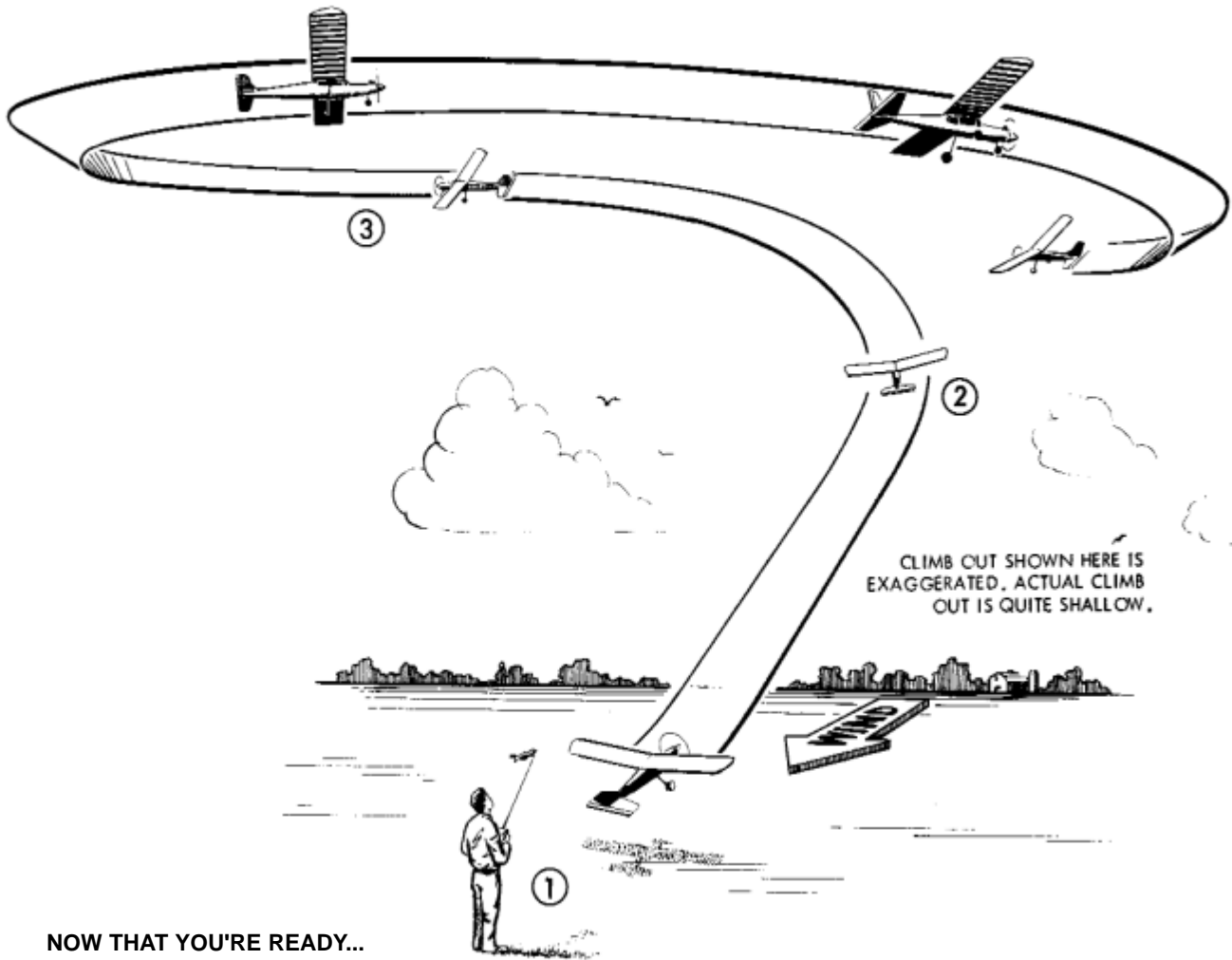

## NOW THAT YOU'RE READY...

Turn on the Tx and Rx and make sure all control surfaces are responding correctly. See that the Tx trim tabs are centered with the surfaces centered and make sure you have a reliable idle and correct High Speed Needle Valve setting and that the Tx meter registers in the "safe" zone.

It is important to have a total flight plan in mind. Look at the flying sketches here to get an idea of the take-off direction and space you will need when flying from your field.

1. Start your engine. Point the model directly into the wind. Advance the throttle smoothly, steering on the ground with rudder the plane will gain speed rapidly. After it rolls about 100 feet, add slight back stick (up elevator) pressure so the model rises smoothly from the ground. With ailerons keep the wings level. Hold only as much back stick as necessary to keep the plane in a 5' to 10' gentle climb (if you climb too steeply the model may slow down and then "stall" and fall to the ground).

2. Be patient, let the model climb slowly to about 150-200 feet of altitude, add just a touch of left (or right aileron) stick pressure until the model begins a very shallow turn in the direction you want to go.

3. Try to maintain this shallow turn. Do not let the turn get too steep (see previous page). The wind will tend to blow your plane further downwind-try to keep it flying upwind at all times prior to your landing approach. It is more difficult to fly a model when it is downwind, and if a mistake is made the model will end up further downwind, making it more difficult to fly back to the field,

To compensate for wind, you should continue making your upwind turns shallow, but make your turns flying with the wind (downwind), a little steeper.

## DANGER—SPIRALS, STALLS, OVERSTRESSING

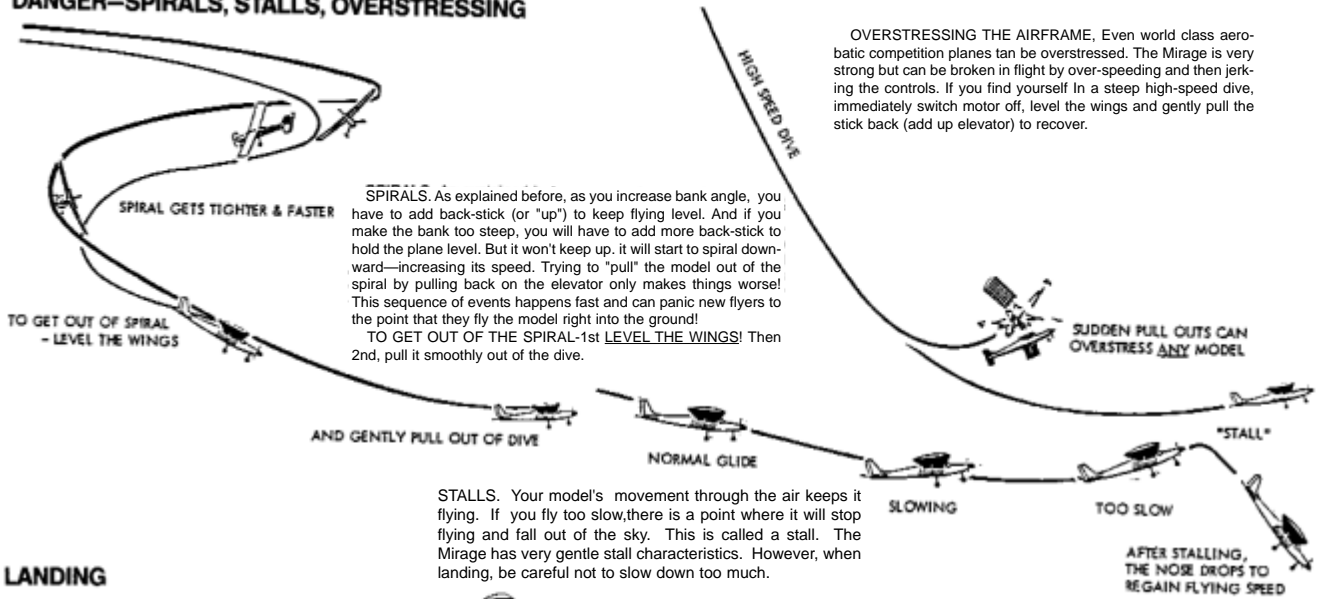

## LANDING

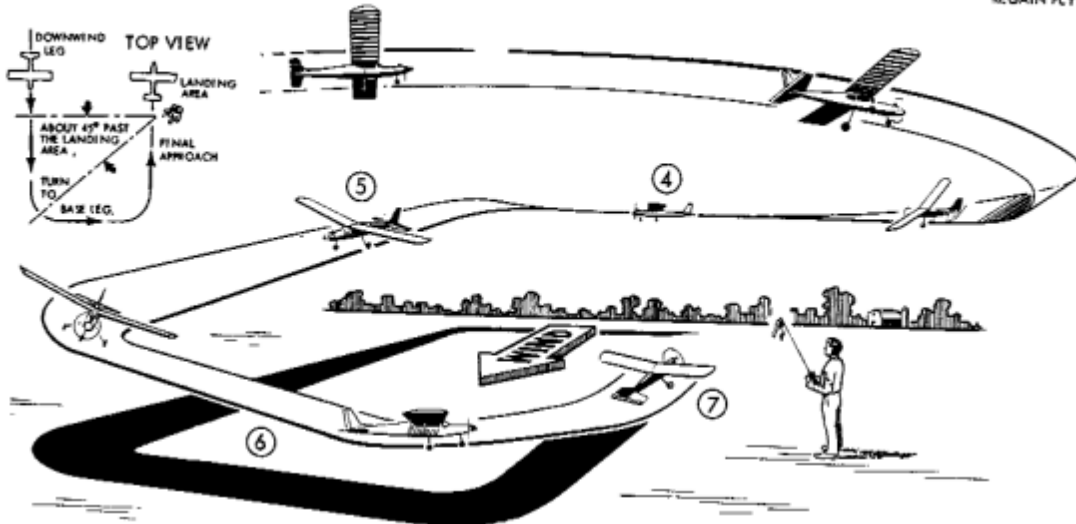

For your first landings, don't be concerned about the model landing on the runway. All you want is that the model land safely. With practice, you'll be able to land where you want. If you can confidently fly the model in wide circles as shown in the illustrations and then simply reduce throttle and glide straight into the wind for your first landings, well that's fine.

### LANDING APPROACH

At most flying fields you will see models flying a rectangular path around the runway—this is called the "pattern." The most important reason for flying the pattern is that as the model flies at different directions in the wind, you will be better prepared for the conditions as you land. Full-size aircraft fly a landing pattern for this same reason. Another important reason for flying the pattern is to organize the take-off and landing traffic, reducing confusion.

The "traffic" pattern consists of: **PATTERN ENTRY, DOWNWIND LEG, BASE LEG, then FINAL APPROACH & LANDING.** And remember, "a good approach is a good landing."



**4. PATTERN ENTRY.** Plan to enter the pattern upwind at about 150 feet of altitude.

**5. DOWNWIND LEG.** Make the downwind leg far enough away to allow for gentle turns to Base Leg and Final Approach. You do not want to make tight "panic" turns when landing. Reduce throttle 1/3rd to begin a slow descent. When the model is about 45° downwind of the landing area turn to Base Leg.

**6. BASE LEG.** Continue your descent, letting the model slowly lose more altitude by reducing throttle to high idle.

**7. FINAL APPROACH & LANDING.** Make a gentle turn to point the model in the direction of the landing area. Reduce throttle to idle. Keep nose of plane slightly down so you don't stall. Steer the plane into the wind as it glides keeping the wings level. Let it settle in towards the ground and land. Just before the model lands you can add a touch of back-stick (up elevator) to "flare" and soften the landing.

Walk over to your plane, stop the engine. Turn off the receiver first, then the transmitter. Stop shaking, congratulations!

# So many Tigers, so little time.

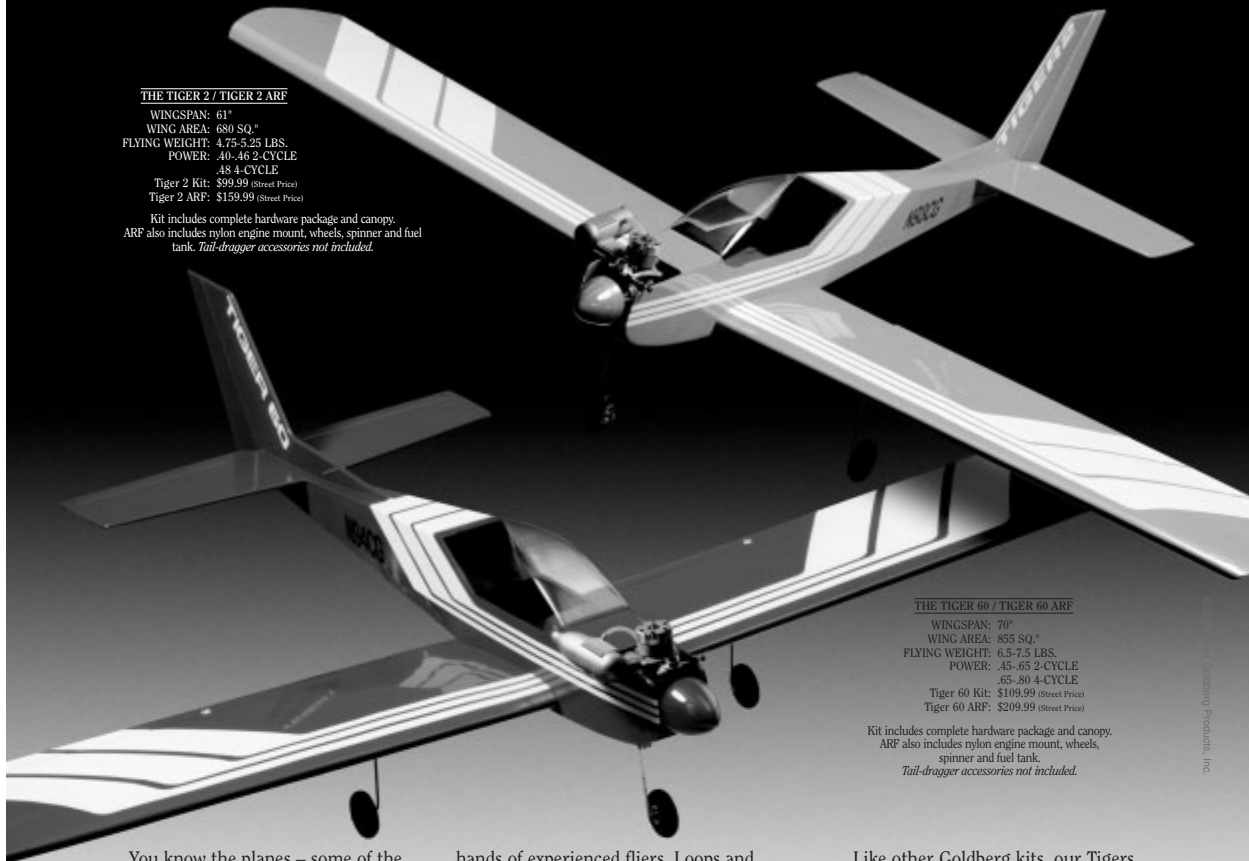

**THE TIGER 2 / TIGER 2 ARF**  
 WINGSPAN: 61"  
 WING AREA: 680 SQ."  
 FLYING WEIGHT: 4.75-5.25 LBS.  
 POWER: 40-46 2-CYCLE  
 48 4-CYCLE  
 Tiger 2 Kit: \$99.99 (Street Price)  
 Tiger 2 ARF: \$159.99 (Street Price)

Kit includes complete hardware package and canopy.  
 ARF also includes nylon engine mount, wheels, spinner and fuel tank. Tail-dragger accessories not included.

**THE TIGER 60 / TIGER 60 ARF**  
 WINGSPAN: 70"  
 WING AREA: 855 SQ."  
 FLYING WEIGHT: 6.5-7.5 LBS.  
 POWER: 45-65 2-CYCLE  
 65-80 4-CYCLE  
 Tiger 60 Kit: \$109.99 (Street Price)  
 Tiger 60 ARF: \$209.99 (Street Price)

Kit includes complete hardware package and canopy.  
 ARF also includes nylon engine mount, wheels, spinner and fuel tank.  
 Tail-dragger accessories not included.

You know the planes – some of the best intermediate flyers in anyone's hangar. Gentle as a kitten when you want them to be, but plenty of growl when you turn them loose. Fun flying was never any better.

Whether you prefer to build them yourself, or the convenience of a 90% pre-built ARF, our Tigers are terrific everyday sport planes for RCers who aren't looking for a challenge every time they head for the flying field.

## THE TIGER 2 A LOW WING TRAINER

With its light wing loading, low landing speed, and tricycle gear, the Tiger 2 is hard to top as a low wing trainer.

Yet those same features - along with long tail moment, shallow dihedral, and clean symmetrical airfoil, make for super-smooth aerobatic performance in the

hands of experienced fliers. Loops and rolls are clean and precise and inverted flight couldn't be easier or more stable.

## THE TIGER 60 THE PERFECT SPORT FLYER

When you're ready to step up, our Tiger 60 will give you the added performance that only a larger model can give.



When you've outgrown the tri-gear, all of our Tigers easily convert into a tail-dragger configuration.

Like other Goldberg kits, our Tigers feature top-quality American-made hardware. All major components are of finest balsa and light ply.

Our ARF versions are pre-covered with iron-on film. Then we've pre-assembled the elevator, installed pushrod guide tubes, included a black cockpit insert, and put in wing guide tubes for quick, easy installation of aileron servo wires.

Both versions include a complete hardware package and our fully-illustrated, step-by-step instruction booklet will have you out at the field in record time.

Get a Tiger now at your local hobby retailer, and you'll have it jumping through hoops in no time.



**CARL GOLDBERG  
PRODUCTS LTD.**

## The Tiger 2, Tiger 2 ARF, Tiger 60 & Tiger 60 ARF. Only from Carl Goldberg Products.

PO Box 818, Oakwood GA 30566

Info: 678-450-0085 Fax: 770-532-2163

www.carlgoldbergproducts.com