

# Futaba

DIGITAL PROPORTIONAL  
RADIO CONTROL

# PCM

## INSTRUCTION MANUAL

### FP-5NLP PCM 5 CHANNEL

 **FUTABA CORPORATION OF AMERICA**  
**FUTABA CORPORATION**

D60401

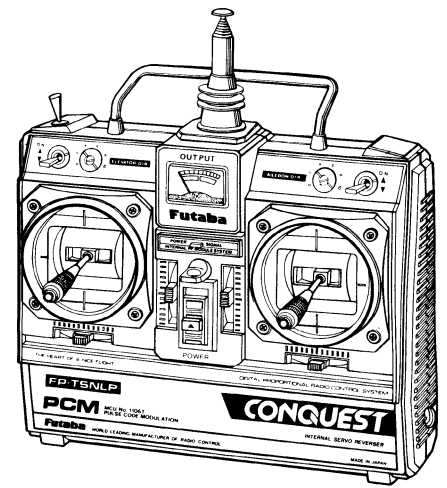

*Thank you for purchasing a Futaba digital proportional radio control set.  
Please read this manual carefully before using your set.*

### FEATURES OF FP-5NLP

*The FP-5NLP is an extremely noise and dead-point resistant PCM (Pulse Code Modulation) radio control set with a micro-processor in the transmitter and receiver.*

*Please read this manual before using your set.*

#### TRANSMITTER FP-T5NLP

- Five channel PCM transmitter with new one-chip micro-processor.
- Reliability substantially improved by using industrial robots to assemble the PC board.
- Servo reversing switch for each channel. Servos are reversed by using these switches.
- Aileron and elevator dual rate.
- Adjustable throttle limiter (ATL) for throttle.
- Newest open gimbal sticks provide maximum operation feel. Stick spring tension can be adjusted.
- Nonslip adjustable lever head can be adjusted to match the length of your hand.
- Crystal can be changed from the outside. The frequency can be changed within the same band by simply changing the crystal.
- RF PC board module style system in transmitter.
- Functional case, created as a result of the exhaustive pursuit of easier operation, has evolved a thick case which fits into the palm of the hand.
- Easy to read square transmitter battery voltage level meter and ON display LED.
- Excellent radiation efficiency, strong 8-stage antenna.
- Neck strap bracket provided as standard. Operation is easier if the transmitter is hung from your neck by using the optional neck strap.
- Conversion to NiCad operation possible. (Service option)

#### RECEIVER FP-R105iP

- High performance and high reliability miniature PCM receiver. The perfect receiver for radio control achieved by the introduction of the newest microprocessor technology.
- Miniature PCM receiver with built-in high-speed one-chip microprocessor. Extremely resistant to adjacent frequency and spark noise interference.
- High resolution and fast response achieved with original Futaba software.
- Penlight battery power supply permits 10 F3A flights with six servos (landing gear servo x 2).
- Easy-to-install lead-wire type power connector.
- Microprocessor servo hold function eliminates erroneous operation when a dead-point is passed, etc.
- Microprocessor throttle fail-safe function improves safety.
- PCM system is resistant to adjacent band interference.

- Crystal can be changed within the same frequency band.
- High quality and high reliability connectors eliminate faulty contact. Special attractive housing improves vibration and shock resistance.
- Vibration and shock resistant by using thru-the-hole plating, of the PC board.

#### SERVO FP-S138

##### SMALL, RUGGED, HIGH NEUTRAL LOW PROFILE SERVO

- Height is 0.2 in (5.2mm) lower than existing servos of its type.
- New indirect drive potentiometer improves vibration and shock resistance and neutral accuracy.
- Futaba low-power custom IC provides extremely high torque, narrow dead band, and superior tracking.
- Fiberglass reinforced PBT (polybutylene terephthalate) injection molded servo case is mechanically strong and invulnerable to glow fuel.
- Strong polyacetal resin ultra-precision servo gear features smooth operation, positive neutral, and very little backlash.
- Fiberglass reinforced epoxy resin PC board with thru-the-hole plating improves servo amp vibration and shock resistance.
- Three pin connector eliminates faulty contact and improves reliability against vibration and shock. Housing has a reverse insertion prevention mechanism.
- Special grommet simplifies mounting of the servo and has an excellent cushioning effect.
- Six special adjustable splined horns.
- Since the output torque is 34.75oz-in (2.5kg.cm) and operating speed is 0.23sec/60°, it can be used with almost all models.

### SET CONTENTS AND RATINGS

(Specifications are subject to change without prior notice.)

	PCM FP-5NLP
Transmitter	FP-T5NLP x 1
Receiver	FP-R105iP x 1
Servo	FP-S138 x 4
NiCad battery	NR-4J x 1
Switch	SSW-J x 1
Others	Charger, Extension cord, Frequency flag, Spare horn, Mounting screw.

## TRANSMITTER FP-T5NLP

Operating system	: 2 stick, all channels servo, reverse
Transmitting frequency	: 72MHz bands
Modulation system	: PCM FM
Power requirement	: 9.6V NiCad battery (NT-8LP)
Current drain	: 190mA

## RECEIVER FP-R105iP

Receiving frequency	: 72MHz bands
Crystal replacement system	: Frequency can be changed within the same frequency band by changing the precision crystal.
Intermediate frequency	: 455kHz
Power requirement	: 4.8V, NiCad batteries (shared with servos)
Current drain	: 15mA
Dimensions	: 1.31 x 1.98 x 0.81 inch (33.4 x 50.4 x 20.5mm)
Weight	: 1.37oz (35g)
Receiving range	: 500m on the ground, 1000m in the air (at the best conditions)

## SERVO FP-S138

Control system	: + pulse width control 1520μsN
Operating angle	: One side 45° or more (including trim).
Power requirement	: 4.8V or 6.0V
Current drain (IDLE)	: 6.0V, 8mA
Output torque	: 34.75oz.in (2.5kg.cm)
Operating speed	: 0.23sec/60°
Dimensions	: 1.69 x 0.79 x 1.4 inch (40.5 x 20 x 35.5mm)
Weight	: 1.45oz (41g)

## TRANSMITTER FP-T5NLP CONTROLS

Fig. 1 shows the name of each part of the transmitter. Memorize the position and operation of each switch and control.

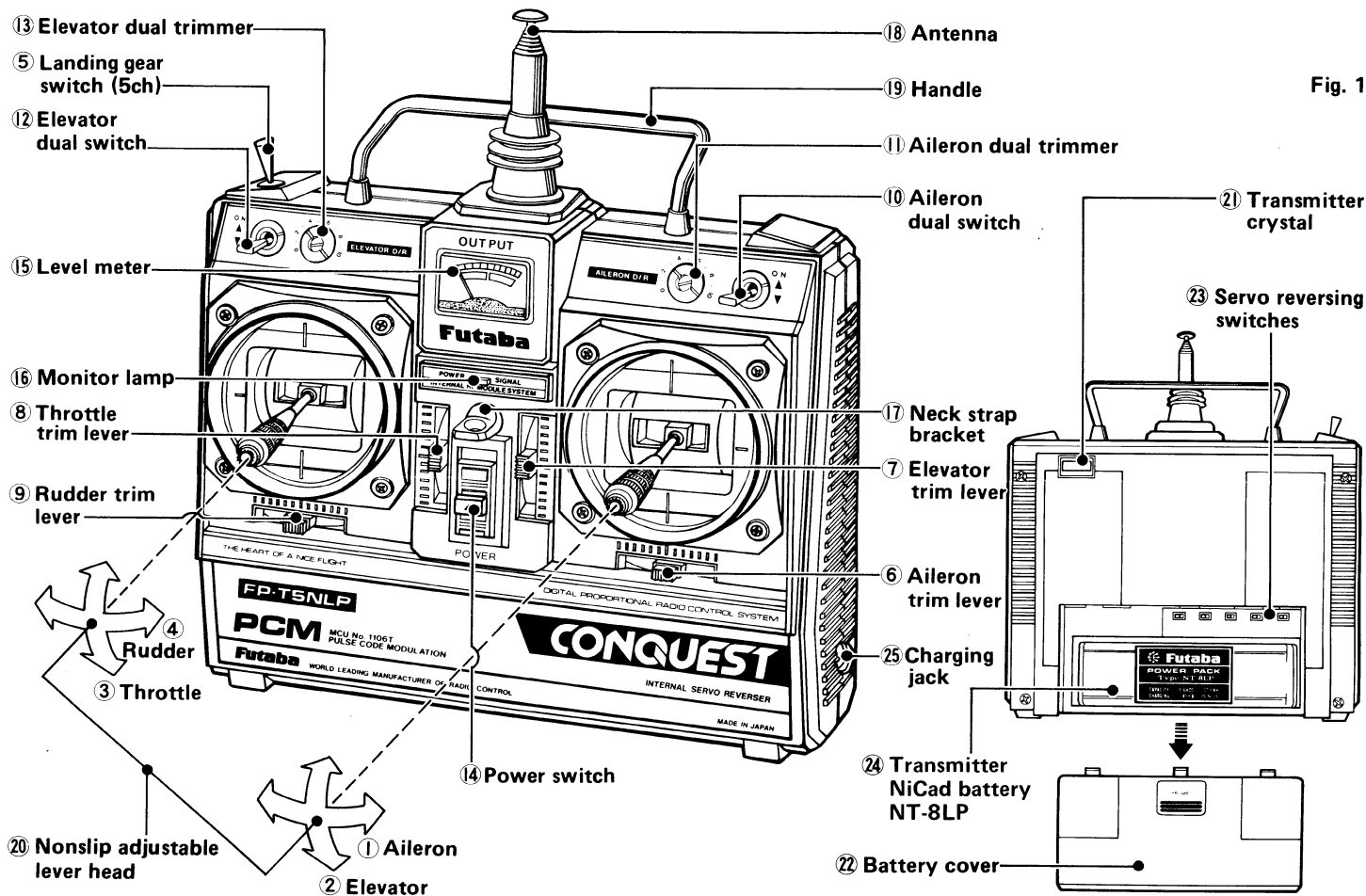

Fig. 1

In the following descriptions, all the servo reversing switches are assumed to be in the normal position. When they are in the reverse position, operation is the opposite of that described.

- ① **Aileron** Aileron operation
- ② **Elevator** Elevator operation
- ③ **Throttle** Throttle operation
- ④ **Rudder** Rudder operation
- ⑤ **Landing gear switch** Raising and lowering the landing gear
- ⑥ **Aileron trim lever** Aileron trimmer
- ⑦ **Elevator trim lever** Elevator trimmer
- ⑧ **Throttle trim lever with ATL**  
This trim lever is effective only at the throttle stick low side.
- ⑨ **Rudder trim lever** Rudder trimmer
- ⑩ **Aileron dual rate switch**  
Aileron dual rate ON-OFF switch. When set to the upper position, dual rate is turned on, and when set to the lower position, dual rate is turned off.

- ⑪ **Aileron dual rate trimmer**  
This trimmer sets the aileron travel when the aileron dual switch is set to on. When the dual switch is set to ON, the servo throw can be set to an arbitrary angle smaller than when the dual switch is OFF (normal) as shown in the figure. Use the throw matched to the aircraft and the maneuvers to be performed.

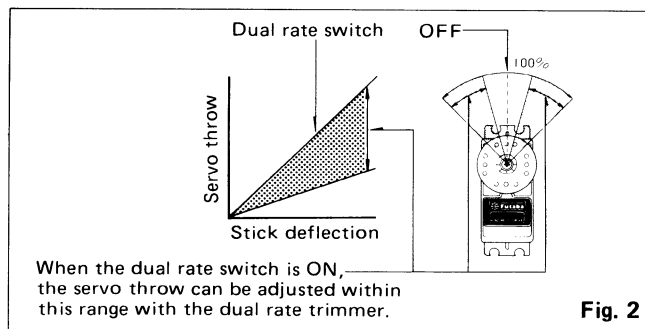

Fig. 2

**12 Elevator dual rate switch**

This switch turns the elevator dual rate function on and off. The lower position is dual rate OFF and the upper position is dual rate ON.

**13 Elevator dual rate trimmer**

This trimmer sets the elevator deflection angle when the elevator dual rate switch is in the ON position. It has the same functions as aileron dual rate.

**14 Power switch**

The upper position is ON.

**15 Level meter**

This level meter indicates the transmitter battery voltage.

**16 Monitor lamp**

When the power switch is set to ON, this lamp comes on and the level meter pointer deflects.

**17 Neck strap bracket**

Bracket for the neck strap (optional).

**18 Antenna**

Strong telescoping antenna, Extend it to its full length when using the transmitter.

**19 Handle**

Use this bar to carry the transmitter.

**20 Nonslip adjustable lever head**

The length of the lever head can be adjusted to fit the operator.

Adjust to the length of your hand.

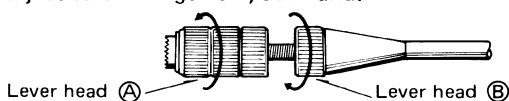

Unlock lever heads (A) and (B), by turning them in the arrow direction, and adjust the head to the most comfortable length, then lock it by turning it in the direction opposite the arrows.

Fig. 3

**21 Transmitter crystal**

**22 Battery cover**

Remove this cover when switching the servo reversing switches.

Remove the battery cover, by pulling it in the arrow direction while pressing downward.

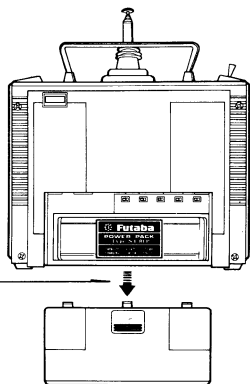

Fig. 4

**23 Servo reversing switches**

Using the servo reversing switches

- The left side of each switch is the normal position.
- The servo reversing switches reverse the direction of operation of the servos.

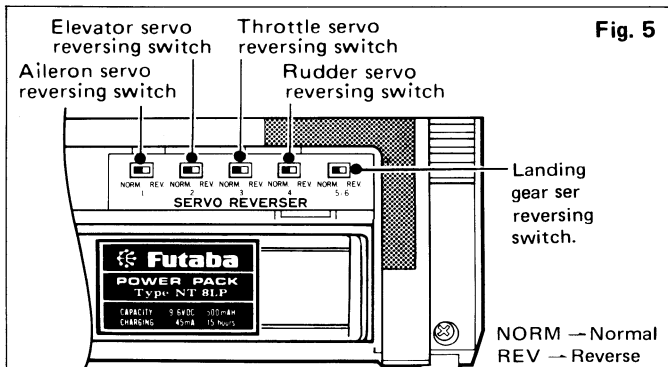

Fig. 5

After linkage is complete, inspect the servos. If the direction of operation of the stick lever and the direction of operation of a servo are opposite, switch the appropriate servo reversing switch.

**24 Transmitter NiCad battery NT-8LP**

**25 Charging jack**

Battery charge jack for built-in NiCad battery.

\*CHARGING OF TRANSMITTER AND RECEIVER NI-CAD BATTERIES:

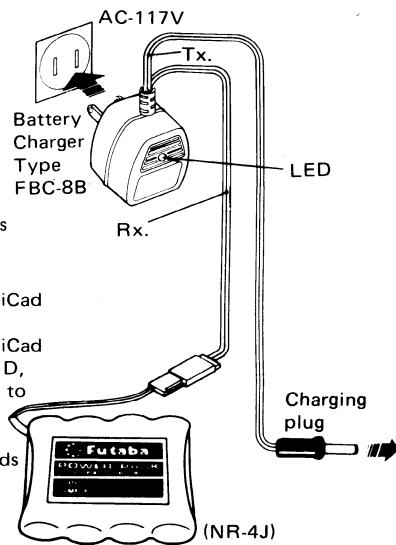

Recharge the receiver and transmitter NiCad batteries as shown in Fig. 6.

**Notes:**

- 1) First, connect to TX NiCad and red lamp goes on.
- 2) Then connect to RX NiCad after connecting, L, E, D, charges color from red to greenish red (orange) which indicates that both TX and RX NiCads are being charged.
- 3) In case of separate charging L, E, D, color will be: RX NiCad - Green. TX NiCad - Red.

Fig. 6

- Connect the charging plug of the FBC-8B charge to the transmitter charging jack, connect the 3P connector of the FBC-8B to the receiver NiCad battery (NR-4J), and plug the FBC-8B to a 117VAC outlet as shown in this figure.
- The Receiver battery can be used about 10 times at 10 minutes per flight between rechargings.
- Charge the batteries for about 15 hours. When the set is not in use for some time, repeat discharge and charge two to three times before use. (If the batteries are not used for a long time, their capacity will go down).
- FBC-8B charges transmitter and receiver NiCad batteries independently or simultaneously.

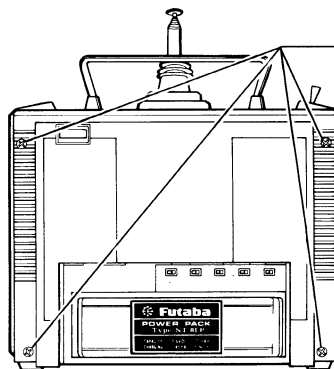

When these screws are removed, the back cover can be removed.

- The tension of the spring can be adjusted by removing the transmitter back cover and turning the screw for each stick. Set the springs for the best stick feel.

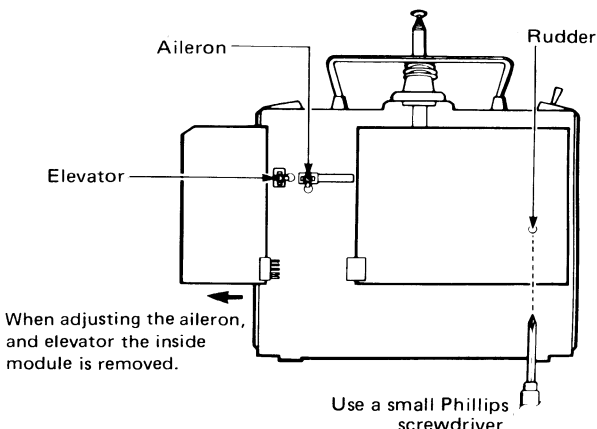

When adjusting the aileron, and elevator the inside module is removed.

Use a small Phillips screwdriver.

Fig. 7

# RECEIVER FP-R105iP, SERVO FP-S138

## Receiver, servos, switches, and NiCad battery connections

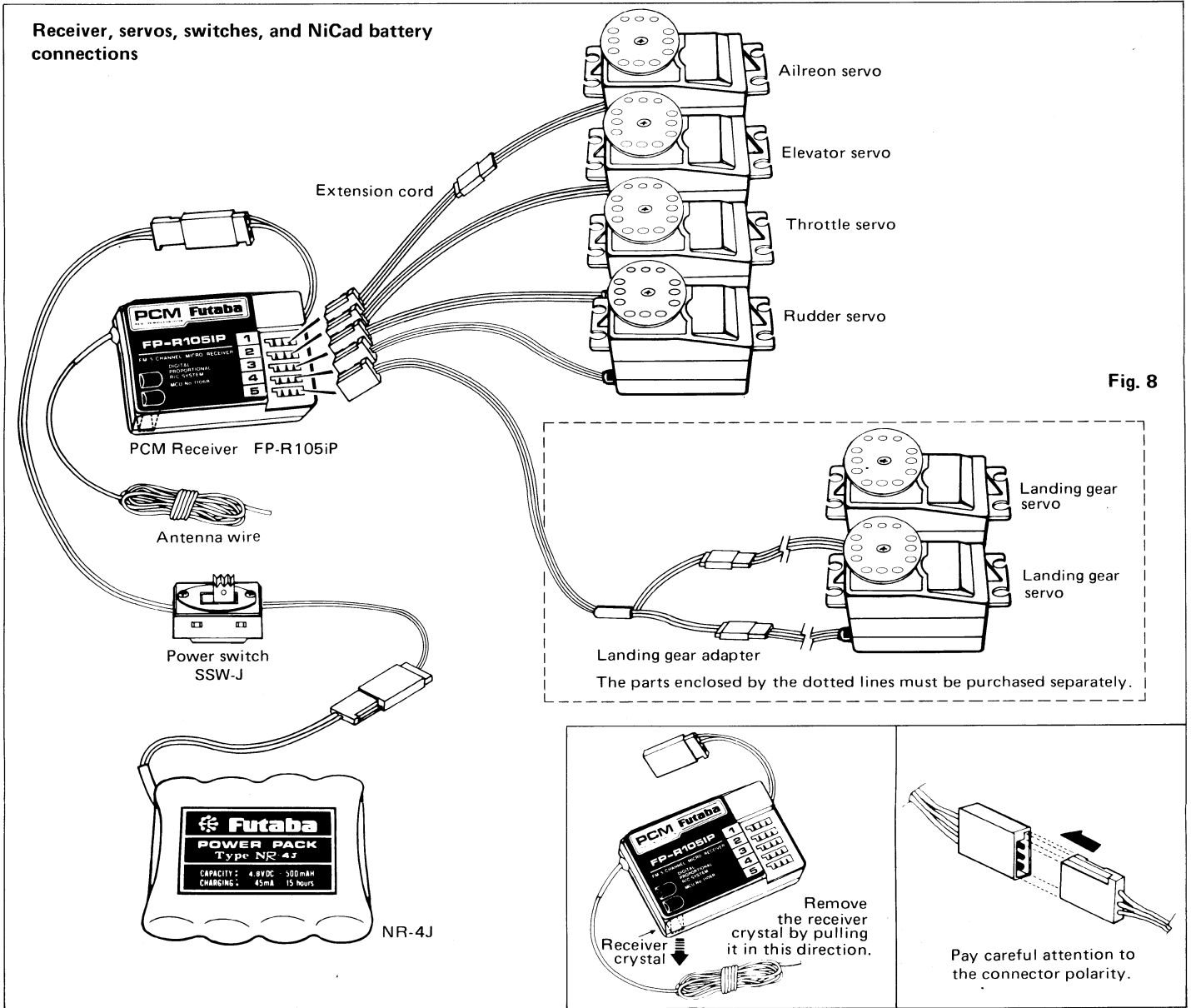

Fig. 8

## PRECAUTIONS

- Connect the receiver, servos, switches, and battery firmly as shown in Fig. 8. Then extend the transmitter and receiver antennas fully.
- Set the transmitter power switch to ON. Then set the receiver power switch to ON. The servos stop near the neutral position. Operate the transmitter sticks and check that each servo follows the movement of the stick.
- Connect the pushrod to each servo horn, then check if the direction of travel of each servo matches the direction of operation of its transmitter stick. To reverse the direction of servo travel, switch the servo reversing switch.
- Operate each servo over its full stroke, and check if the push-rod binds or is too loose. Applying unreasonable force to the servo horn will adversely affect the servo and quickly drain the battery. Always make the travel of each control mechanism somewhat larger than the full travel (including trim) of the servo horn. Adjust the servo horns so that they move smoothly even when the trim lever and stick are operated simultaneously in the same direction.
- Be alert for noise. This set is noise-resistant, but is not completely immune to noise. We recommend the use of noiseless parts.
- When installing the switch harness, cut a rectangular hole somewhat larger than the full stroke of the switch and install the switch so that it moves smoothly from ON to OFF. This

also applies to the switch mount when the switch is installed inside the fuselage and is turned on and off from the outside with a piece of wire, etc. Install the switch where it will not be exposed to engine oil, dust, etc.

- Even though the receiver antenna is long, do not cut or bundle it.
- Install the servos securely. Tighten the mounting screws until the rubber grommet is crushed slightly. If the screws are too tight, the cushioning effect will be adversely affected.

## SERVO MOUNTING

[Using wood screws]

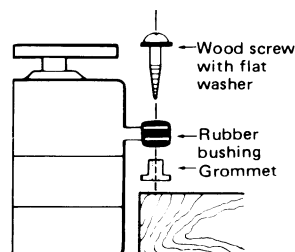

[Using plywood, FRP, or aluminum sheet]

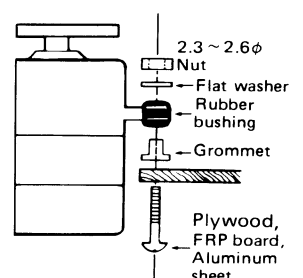

Fig. 9

- The crystal can be changed from the outside of the receiver case. Always use the Futaba transmitter/receiver matched crystal set to change the band.
- Spare servo horns are supplied. Use them as needed.
- Wrap the receiver in sponge rubber. Waterproof and dust-proof the receiver by placing it in a plastic bag and wrapping a rubber band around the open end of the bag. Do the same with the receiver/servo battery.
- Use the rubber bands wrapped around the receiver to hold the servo and switch leads.
- After mounting is complete, recheck each part, then check the range by making the transmitter antenna as short as possible, extending the receiver antenna fully, and operating the set from a distance of 20m to 30m. The movement of each servo should follow the movement of each stick of the transmitter.
- After mounting and checking are complete, take your model to the shop where you purchased the set, or to an experienced radio control modeler, and ask them to teach you how to handle your radio control set in the proper manner and to inspect your set-up carefully.
- To enjoy radio control models fully, be sure to observe all safety standards.

### FP-R105iP HOLD function

Hold function stops all servos at the last position before false signals are received by the receiver or transmitter signal is cut to the receiver. Once correct signals are received, the hold function is released. False signals may be radio interference or noise.

### FP-R105iP throttle FS (Fall Safe function)

Throttle fail safe function sets the throttle servo to low (as shown in figure 9) when a false signal is received or transmitter is cut to the receiver. The receiver enters throttle FS when a false signal is received for one or more seconds. When the radio interference or noise causing the false signal ceases or a correct signal is received. The throttle FS is reset and normal operation resumes.

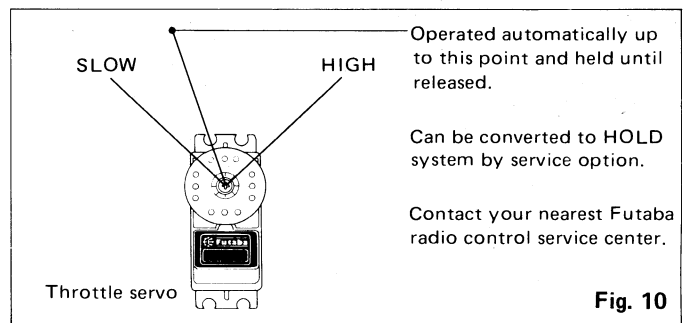

Fig. 10

### AILERON AND ELEVATOR DUAL (dual rate ON, OFF) ADJUSTMENT

When the dual switch is set to ON, the servo throw is made smaller by the amount shown by the hatched lines in Fig. 10. The servo throw can be set from 40% to 100% of the total travel by adjusting the trimmer next to the switch with a flat bladed screwdriver. When the dual rate switch is set to OFF, the throw is normal. When desiring a larger throw, such as for spins, etc., set the dual rate switch to OFF and adjust the throw mechanically by horn and rod adjustment. Set the dual rate switch to on for level flight and adjust the trimmer for the required amount of throw.

When the dual rate switch is set to OFF, dual rate is set and the throw becomes large.

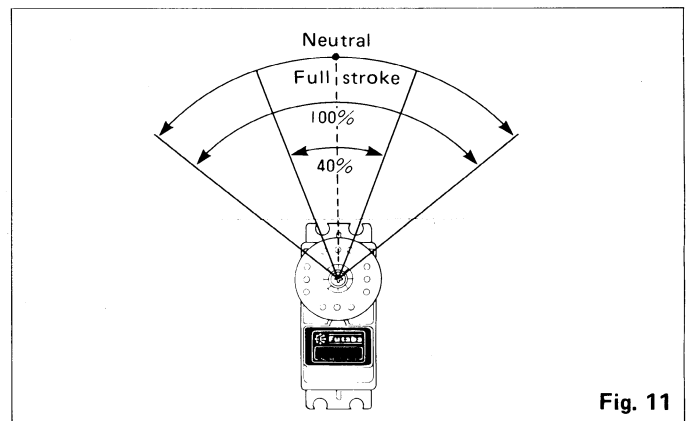

Fig. 11

## SPLINED HORNS

This horn permits shifting of the servo neutral position at the servo horn. Setting and shifting the neutral position

#### a) Angle divisions

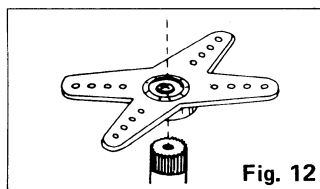

Fig. 12

1) The splined horn has 25 segments. The amount of change per segment is:  $360 \div 25 = 14.4^\circ$

2) The minimum adjustable angle is determined by the number of arms or number of the holes. For four arms, the minimum adjustable angle is:

$$360^\circ \div \frac{(25 \times 4)}{\text{Number of divisions}} = 3.6^\circ$$

#### b) Effect

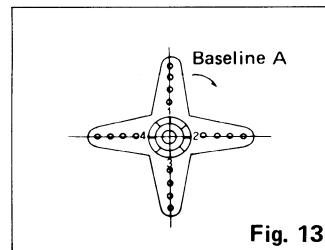

Fig. 13

To shift the holes center line to the right (clockwise) relative to baseline A, shift arm 2 to the position of arm 1 and set it to the position closest to baseline A.

[Example] For a four arm horn, the angular shift per segment is  $14.4^\circ$ . The shift to the right is  $90^\circ - (14.4 \times 6) = 3.6^\circ$

To shift by the same angle in the opposite direction, use the opposite arm number.

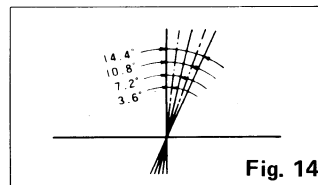

Fig. 14

For a six arm horn, turn the arm counterclockwise and set arm 2 to the position of arm 1. The adjustable angle is  $60^\circ - (14.4 \times 4) = 2.4^\circ$ .

Arm 3 shift  $4.8^\circ$  to the right, arm 6 shifts  $2.4^\circ$  to the left, and arm 4 shifts  $7.2^\circ$  to the right and left.

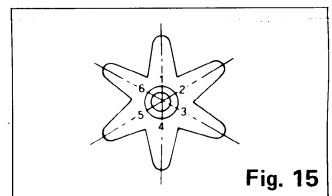
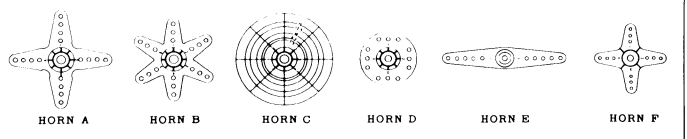

Fig. 15

The following splined horns are optional.

Fig. 16



**FP-S138**

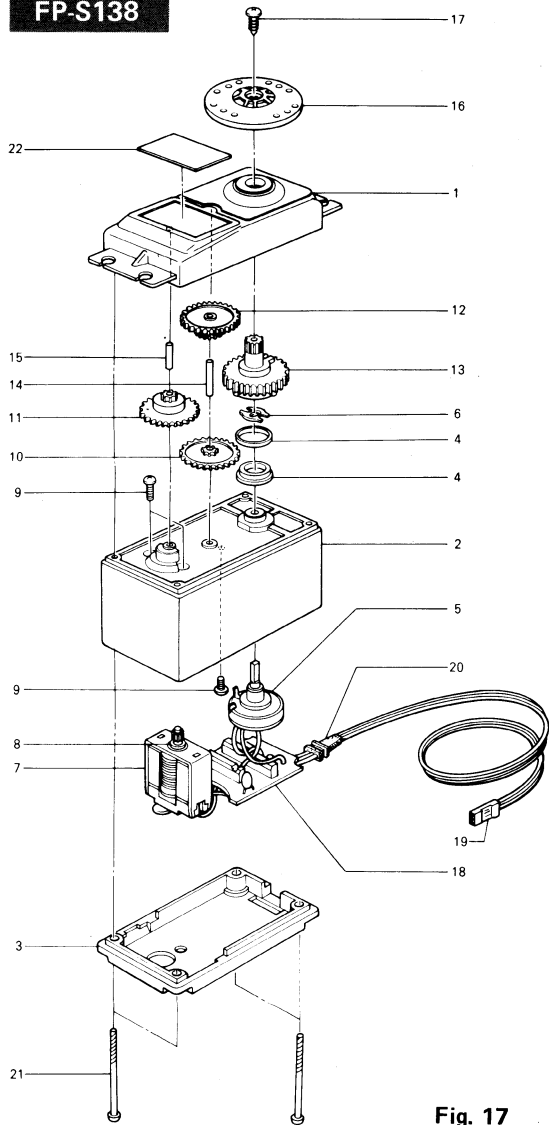

**Fig. 17**

No.	Part Name	Part No.
1	Upper case	S05650
2	Middle case	S06010
3	Bottom case	S06020
4	Metal bearing	S04134
5	Potentiometer	I39995
6	VR drive plate	S02753
7	Motor	S91218
8	Motor pinion	S02461
9	VR set screw	J55016
10	1st gear	S02751
11	2nd gear	S02491
12	3rd gear	S02492
13	Final gear	S02752
14	Intermediate shaft	S02495
15	2-stage shaft	S02494
16	Servo horn D	S01239
17	Horn set screw 2.6x8	J55178
18	Printed wiring board . . . S138	AS1305
19	S138 . . . 3PB-WRB300	AT2465
20	Lead wire packing	S90045
21	Case set screw	J50360
22	Nameplate . . . S138	S60141

**USING THE ANTENNA FREQUENCY FLAG**

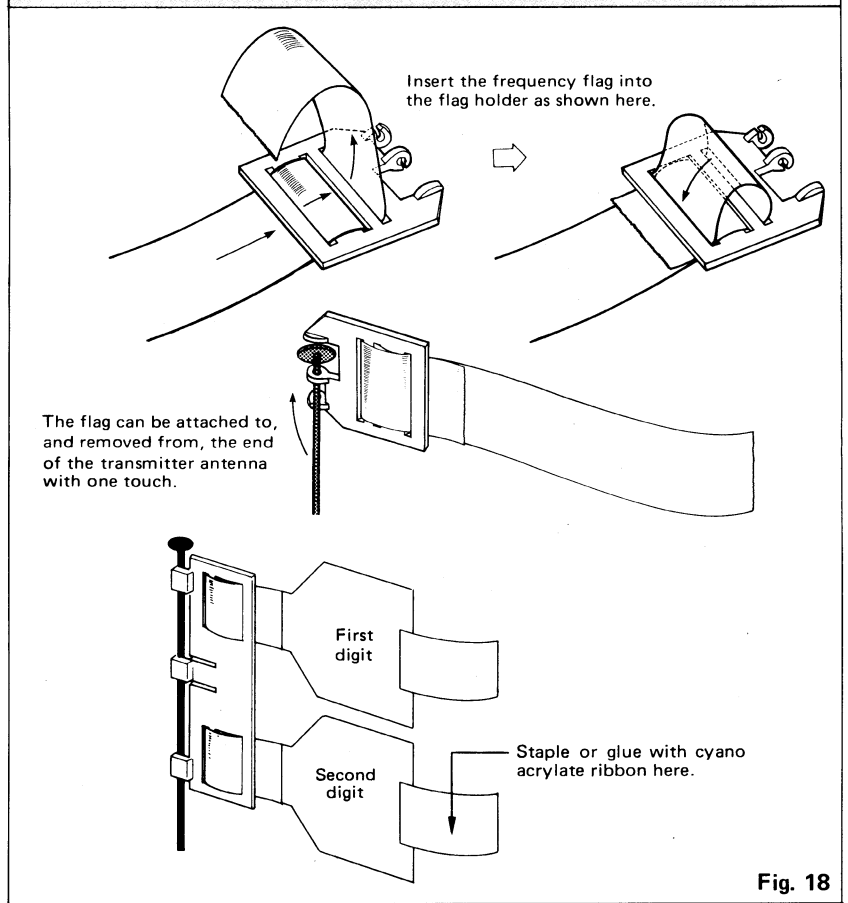

**Fig. 18**

**REPAIR SERVICE**

- To insure prompt service, please follow the instructions given below.
1. Charge the batteries for at least 18 hours prior to shipment.
  2. Return the system only. Not your complete installation. Remove the servos from their mounts and remove the foam padding from the receiver.
  3. Plugs or other modifications which interfere with factory test procedures will be returned to factory standard at your expense.
  4. Carefully pack all components individually, using sufficient packing material to prevent damage during shipment.
  5. Include a brief but thorough explanation of all problems and service required and tape it to the back of the transmitter. Place a label describing the function of the servo on each servo.
  6. Be sure to include your full address and tel. No., zip code inside the box as well as on the outside.
  7. Include a packing list of all items being returned, and double check to make sure that all items are packed.
  8. Upon receipt of your equipment at the Futaba factory, an estimate of the cost of repair (over \$25.00 only) will be sent to you. Your equipment will then be repaired and returned to you upon receipt of payment or C.O.D. (cash).
- This factory repair service applies only to the continental U.S.A., Hawaii, and Alaska.

**WORLD SALES & SERVICE FACILITIES**

- |                   |   |                      |   |
|-------------------|---|----------------------|---|
| <b>Australia:</b> | FUTABA SALES AUSTRALIA PTY. LTD.,<br>MELBOURNE TEL: 211-4788              | <b>Lebanon:</b>      | KHAIRALLAH MODELRCRAFT, BEIRUT<br>TEL: 326-681                          |
| <b>Argentina:</b> | MODELISMO AERONAUTICO DEGA SRL.<br>BUENOS AIRES TEL: 393-2299             | <b>New Zealand:</b>  | AMALGAMATED WIRELESS<br>(AUSTRALIA) N.Z. LTD. WELLINGTON<br>TEL: 58-979 |
| <b>Canada:</b>    | UDISCO LTD., MONTREAL<br>TEL: 481-8109                                    | <b>Norway:</b>       | HARALD LYCHE CO. A/S, Drammen<br>TEL: (03) 83 39 70                     |
| <b>Chile:</b>     | HOBBY LANDIA, SANTIAGO<br>TEL: 743957                                     | <b>Singapore:</b>    | SINGAPORE HOBBY SUPPLIES<br>TEL: 533-0337                               |
| <b>Denmark:</b>   | FUTABA IMPORT DENMARK,<br>COPENHAGEN TEL: 02-91-0101                      | <b>South Africa:</b> | REDIPAK (PTY.) LTD.,<br>JOHANNESBURG TEL: 21-1511                       |
| <b>England:</b>   | RIPMAX LIMITED, LONDON<br>TEL: 01-8048272                                 | <b>Spain:</b>        | HOBBY & TOY INTERNATIONAL,<br>VALENCIA TEL: (96) 357 23 93              |
| <b>Finland:</b>   | NORETRON KY, HELSINKI<br>TEL: 90-488880                                   | <b>Sweden:</b>       | RADIO CONTROL CENTER,<br>JONKOPING TEL: 036-145360                      |
| <b>Greece:</b>    | C. & G. MACRIYIANNIS CO., PIRAEUS<br>TEL: 021-3604 391 • or 021-4176191   | <b>U.S.A.:</b>       | FUTABA CORPORATION OF AMERICA,<br>CALIFORNIA TEL: 213-537-9610          |
| <b>Hong Kong:</b> | RADAR CO. LTD. TEL: 3-680507  | <b>W. Germany:</b>   | ROBBE MODELLSPORT GMBH,<br>GREBENHAIN TEL: 06644-870                    |
| <b>Italy:</b>     | RADIO SISTEMI SRL, Carrara<br>TLX: 500494 FORTIM I<br>FAX: 0039-585-52247 |                      |   |



**FUTABA CORPORATION OF AMERICA**

555 West Victoria Street, Compton, Calif. 90220, U.S.A.

Phone: 213-537-9610 Telex: 23-0691227 Facsimile: 213-637-8529

**FUTABA CORPORATION**

Tokyo Office: Inagaki Bldg., 1-21-3, Kanda Suda-cho, Chiyoda-ku, Tokyo 101, Japan

Phone: (03) 255-6811 Facsimile: (03) 255-6880