

Dynaflite™

Bird of Time

- ***Nostalgic competition glider***
- ***Large, 108" wingspan • Light wing loading***

READ THROUGH THIS INSTRUCTION MANUAL FIRST. IT CONTAINS IMPORTANT INSTRUCTIONS AND WARNINGS CONCERNING THE ASSEMBLY AND USE OF THIS MODEL.



Instruction Manual

REQUIRED FOR OPERATION

- 2-3 Channel radio system
- High-start, winch or other launch system
- Field equipment

WARRANTY

Dynaflite guarantees this kit to be free from defects in both material and workmanship at the date of purchase. This warranty does not cover any component parts damaged by use or modification. In no case shall Dynaflite's liability exceed the original cost of the purchased kit. Further, Dynaflite reserves the right to change or modify this warranty without notice. In that Dynaflite has no control over the final assembly or material used for final assembly, no liability shall be assumed nor accepted for any damage resulting from the use by the user of the final user-assembled product. By the act of using the user-assembled product, the user accepts all resulting liability. If the buyer is not prepared to accept the liability associated with the use of this product, return this kit immediately in new and unused condition to the place of purchase.

**MADE IN
USA**

PROTECT YOUR MODEL, YOURSELF & OTHERS BY FOLLOWING THIS IMPORTANT SAFETY PRECAUTION

Your Bird of Time is not a toy, but a sophisticated working model that functions very much like a full-size airplane. Because of its realistic performance, the Bird of Time, if not assembled and operated correctly, could possibly cause injury to yourself or spectators and damage property.

To make your R/C modeling experience totally enjoyable, we recommend that you get experienced, knowledgeable help with assembly and during your first flights. You'll learn faster and avoid risking your model before you're truly ready to solo. Your local hobby shop has information about flying clubs in your area whose membership includes qualified instructors.

You can also contact the national Academy of Model Aeronautics (AMA), which has more than 2,300 chartered clubs across the country. Through any one of them, instructor training programs and insured newcomer training are available. Contact the AMA at the address or toll-free phone number below.

Academy of Model Aeronautics
5151 East Memorial Drive
Muncie, IN 47302
(800) 435-9262
Fax (317) 741-0057

PRECAUTIONS

1. You must assemble the plane according to the instructions. Do not alter or modify the model, as doing so may result in an unsafe or unflyable model. In a few cases the instructions may differ slightly from the drawings or plan. In those instances you should assume the written instructions are correct.

2. You must take sufficient time to build straight, true and strong.
3. You must properly install all R/C and other components so that the model operates properly on the ground and in the air.
4. You must test the operation of the model before the first and each successive flight to insure that all equipment is operating correctly. You must also make certain that the model has remained structurally sound.

NOTE: We, as the kit manufacturer, can provide you with a quality kit and great instructions, but ultimately the quality and flyability of your finished model depends on how you assemble it; therefore, we cannot in any way guarantee the performance of your completed model and no representations are expressed or implied as to the performance or safety of your completed model.

INTRODUCTION

Congratulations on your choice of this kit for your next project. The Bird of Time is an unusual looking model that has the presence only a big model can carry off.

At Dynaflyte we take pride in offering kits that are simple and straightforward to build and provide value for your modeling dollar. Because of the size and cost of this model, we assume you have built several models and have a general working knowledge of modeling and its terms. If you HAVE NOT built and flown several kits, we suggest that you get some experience before beginning this kit.

Please inventory and inspect all parts carefully before starting to build! If any parts are missing, broken or defective or if you have any questions about building or flying this model, please call us at (217) 398-8970 and we'll be glad to help. If you are calling for replacement parts, please look up the part numbers and have them ready when calling.

REQUIRED ITEMS

- 2-3 channel radio with 2-3 micro or mini servos
- Top Flite® MonoKote® covering (approx. 3 rolls)
- 1/4" Latex Foam Rubber (HCAQ1000)

OPTIONAL

- Remote tow hook release
- Paint for fuselage (Top Flite® LustreKote™)

SUGGESTED SUPPLIES

- 2 oz. Thin CA Adhesive - (GPMR6003)
- 1 oz. Thick CA Adhesive - (GPMR6015)
- CA Accelerator - (GPMR6035)
- CA Applicator Tips - (HCAR3780)
- 6-Minute Epoxy - (GPMR6045)
- 30-Minute Epoxy - (GPMR6047)
- 4 oz. Aliphatic Resin Glue (GPMR6161)

On our workbench, we have four 11" Easy-Touch™ Bar Sanders, equipped with #50, #80, #150 and #220-grit sandpaper. This setup is all that is required for almost any sanding task. Custom sanding blocks can be made from balsa for sanding hard-to-reach spots. We also keep some #320-grit wet-or-dry sandpaper handy for finish sanding before covering.

IMPORTANT BUILDING NOTE: During construction you will be using a number of balsa sticks to frame various assemblies. Ample material is included but you should study the plans, then make an effort to cut the longest pieces you will need first. Label the pieces as you cut them for later reference. By doing this now, you won't have to splice pieces together later.

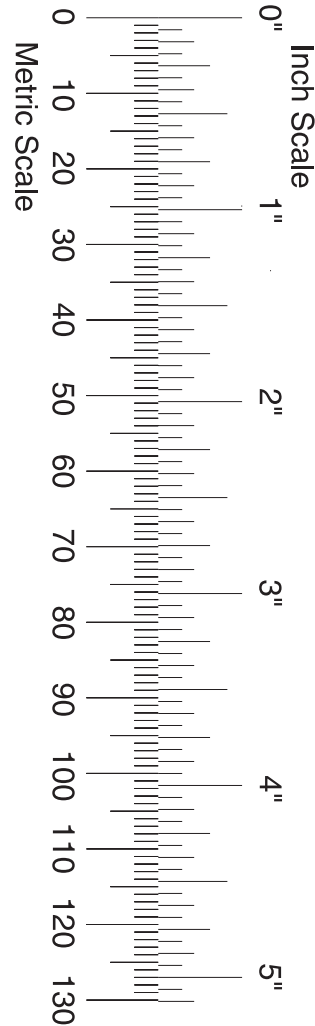

DIE-CUT PATTERNS

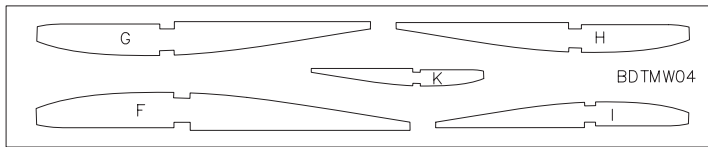
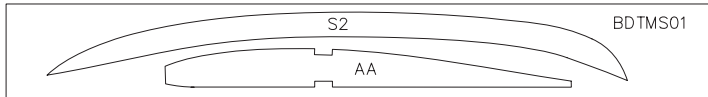
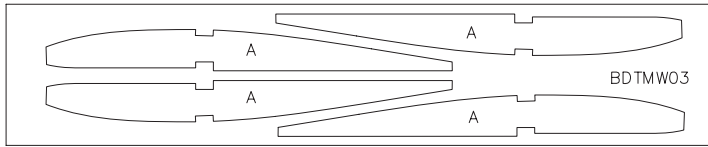
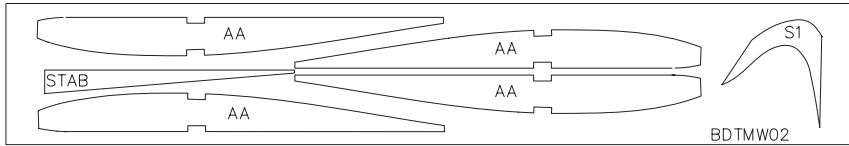
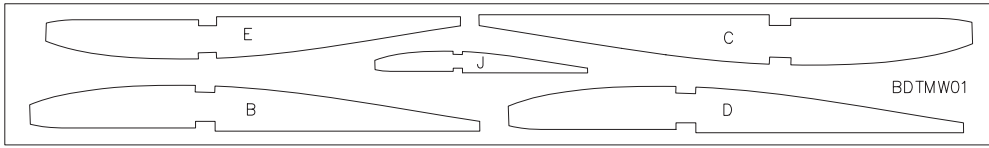

BDTMW05

TOW HOOK	AFT SHEAR WEB	AFT SHEAR WEB	
DOUBLERS	FORWARD SHEAR WEB		
	FORWARD SHEAR WEB		

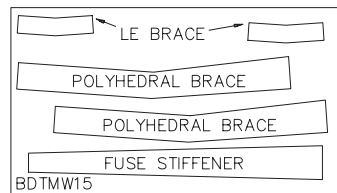
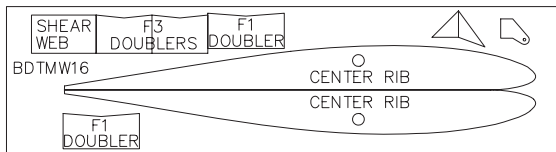

DIE-CUT PATTERNS

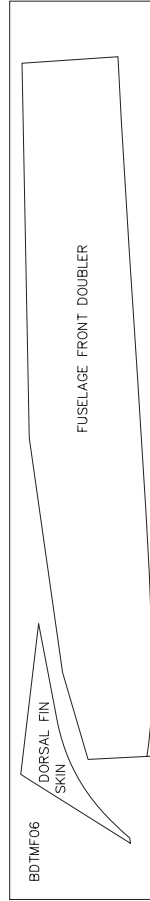
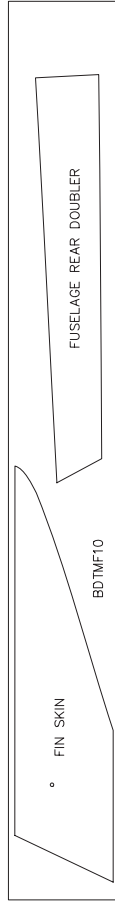
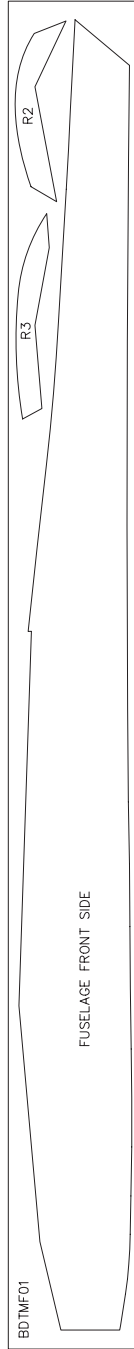
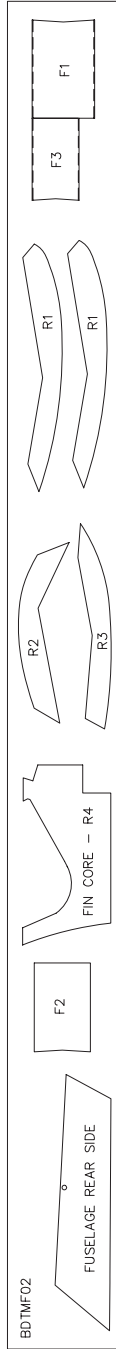
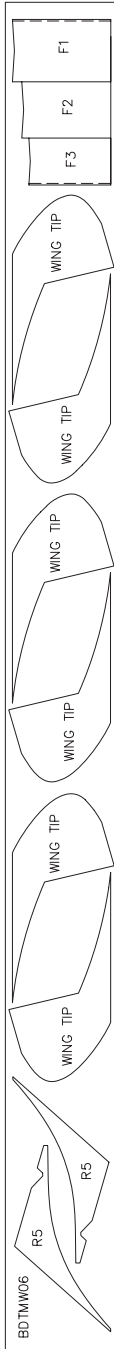

BUILD THE WING

NOTE: It is easier to build the inboard and outboard panels at one time, although it is not important to do so. Just don't glue them together as they must be separated to prepare them for the polyhedral joint.

❑❑ 1. Cut the Leading Edge Shaping Template and Inboard Dihedral Gauge from the plan. Cover the left wing plan with wax paper to prevent the structure from being glued to the plan.

❑❑ 2. Trim a piece of 1/16" x 4" x 36" balsa sheet to 24". Save the cutoff piece for use later. Trim this 24" piece to a width of 3-9/16". Pin this leading edge sheeting over the inboard panel plan with the aft edge of the sheeting flush with the aft edge of the spar line.

❑❑ 3. Shape the center wing sheeting using the piece cutoff in the previous step. There is an extra piece of 1/16" x 3" x 36" sheeting provided for this sheeting as well. Pin it to the board and glue the seams with thin CA adhesive.

Trim this piece from the
1/16" x 3" x 36" sheet.



Glue cut-off piece in position

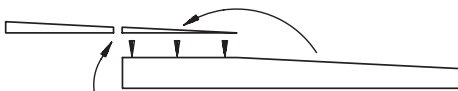

Trim end as shown

❑❑ 4. The outer panel leading edge sheeting is made from a 1/16" x 3" x 36" balsa sheet. Lay the sheet over the plan and trim to the proper shape. CA the triangular piece that you cut off to the inboard end of the sheet to bring it to the required width. Trim this sheet to the proper length and pin it to the plan with the aft edge of the sheeting flush with the aft edge of the spar line.

❑❑ 5. Using aliphatic resin, glue the 1/8" x 3/8" x 24" hardwood inboard spar to the inboard lower sheeting, flush with the rear edge. Similarly, glue the 1/8" x 3/8" x 36" balsa outboard spar to the outboard lower sheeting. Be careful not to glue the outer panel to the inner panel.

❑❑ 6. Remove the ribs from the die-cut sheets, marking each rib with its identification as it is removed. Lightly sand the back of the sheet, if needed, for clean removal. Lightly sand each part to remove any fuzz or die-cutting irregularities, taking care not to alter the contour of the part in the process. Check each rib to insure the spar notches are clean and fit the spar.

❑❑ 7. Note the difference between the A and AA ribs (the aft end of the AA rib is narrower). Stack the A ribs together and lightly sand them so that they are all of the same width and contour, **being careful not to alter the airfoil's shape**. Do the same for the AA ribs.

❑❑ 8. Study section W-W for the installation of the wing joiner tube. Sharpen the end of a 1/4" I.D. brass tube (or use a drill) to make a hole at the proper location in one of the AA ribs. The hole should be located so that the tube will just touch the top spar.

❑❑ 9. Glue the Inboard Dihedral Gauge to a piece of leftover balsa or ply, then cut and sand it to the proper shape. Put the root AA rib (from step 8) in place on the spar and use the Inboard Dihedral Gauge to insure it is at the proper angle as shown in detail W-W (3.5 degrees). Glue the rib to the spar and center sheeting with CA being careful that the rib is properly aligned with the dihedral gauge and inboard edge of the wing. **This alignment is important as even a small error will produce a large shift on a ten foot wing**. Pin the rear of the rib securely to the building board. **Do not** glue the rib to the leading edge sheeting at this time.

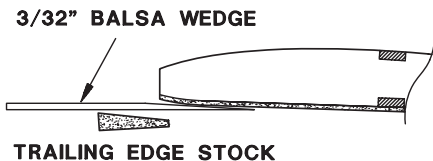

NOTE: The Bird of Time uses a "Phillip's Entry Airfoil." This requires the bottom leading edge sheeting to be pulled up onto the ribs when they are glued to the sheeting. To do this easily, take some 3/32" balsa from your scrap box and cut a piece about 6" long and 1/2" wide. Sand one end to a narrow taper over the last inch. **With the spar held securely to the building board**, slide this under the leading edge sheeting. Then wedge the narrow edge of a piece of trailing edge under the front edge of the sheeting. This will hold the sheeting in close contact with the rib. Use thin CA to glue the rib to the sheeting.

10. Glue the root rib AA to the leading edge sheeting with CA using the above technique to get the "Phillip's Entry Airfoil." Double check the alignment of the rib as you do this.

11. Starting from the inboard end, install the **2nd, 3rd, 4th and 5th "A" ribs**, gluing them to the spar and leading edge sheeting as above. Check the spacing with the 3/8" x 9/16" x 2-7/8" vertical grain shear webs prior to gluing the ribs. Pin the rear of the ribs securely to the building board. **Do not** install the first "A" rib or the one at the polyhedral joint.

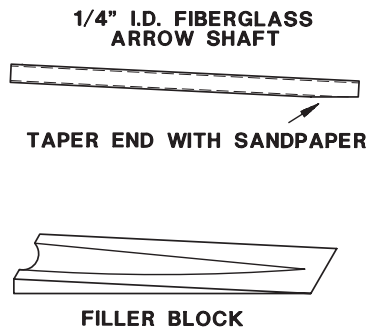

12. Taper the outboard end of the 1/4" I.D. fiberglass arrow shaft for about 1-1/4" as shown in section W-W. This will permit the proper angle of dihedral. Roughen the outside of this tube with sandpaper. From a piece of 3/8" x 3/8" x 18" balsa, make the filler blocks that support the fiberglass tube. **Do not glue the blocks at this time.** Make sure the top filler block does not intrude into the top spar area. You can use the sharpened 1/4" I.D. brass tube to cut channels in the filler blocks.

13. Saw the main-spar polyhedral braces from the 1/8" plywood and sand them to the correct dimensions. Using 6-minute epoxy, glue the polyhedral brace in place on the inner wing panel. (These pieces are not cut from lite plywood. Rather than cut them fully and end up with ragged edges we felt it better for you to do the final cutting.)

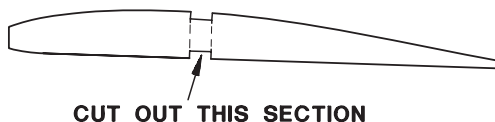

14. Check the fit of the 3/8" x 9/16" x 2-7/8" vertical grain shear webs making sure they don't protrude into the top spar area. Glue them into place with 6-minute epoxy. Cut a section out of one of the

"A" ribs between the top and bottom spar cutouts and glue this to the end of the innermost shear web. Make sure the webs are aligned with the spars in the two bays with plywood shear webs.

□ □ 15. Fit the four plywood shear webs to the inboard panel. Sand the **inner "AA" rib** to fit as needed. **Do not glue at this time.** Cut and fit two balsa shear webs from leftover 1/16" sheeting for the tube areas not covered by the ply shear webs. These will act as dams to prevent epoxy from running out of the wing tube cavity in the next step.

NOTE: In the next step you will use epoxy to glue several parts in the inner wing tube area. Use **30-minute epoxy** for this as 6-minute epoxy cures to rapidly. You will need several clamps; spring type clothespins work well.

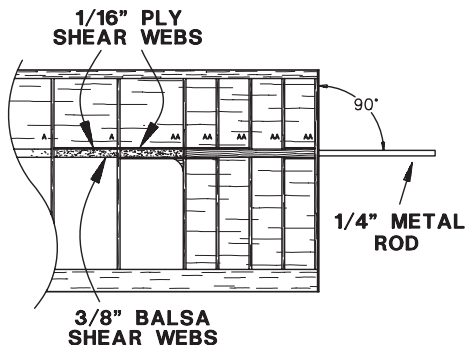

□ □ 16. Mix approximately 1/2 ounce of 30-minute epoxy in a mixing cup. Using a liberal quantity of epoxy, install the filler blocks and tube from step 12. Next, glue the four 1/16" plywood shear webs and two 1/16" leftover balsa shear webs to the lower spar, 3/8" balsa shear webs and tube assembly with epoxy. Finally, epoxy the top hardwood spar to the polyhedral brace, "A" ribs, 3/8" balsa shear webs, tube assembly and inner "AA" rib. Clamp the parts together and check the alignment of the parts before the epoxy sets up. Insert the 1/4" metal rod into the tube and check that it is at a 90-degree angle with the side of the inner "AA" rib.

While the epoxy cures, it's a good time for a cup of coffee. The rest of the wing goes quickly after all the glue has cured.

□ □ 17. Cut the remaining four "AA" ribs and one "A" rib to fit and install with CA. Pin the rear of the ribs securely to the building board. Do not install the "A" rib at the polyhedral joint yet.

□ □ 18. Install the outboard ribs "B" through "K" and glue to the spars and leading edge sheeting with CA as before. Pin the rear of the ribs securely to the building board.

□ □ 19. Cut the short trailing edge piece at the polyhedral joint from the piece of 1/4" x 1-1/8" balsa. Glue all three trailing edge pieces to the ribs with CA. **Do not** glue the inner and outer panels to each other.

□ □ 20. Trim the outboard lower sheeting and the outboard spar to fit the die-cut wing tip. Laminate three wing tip pieces together with thick CA. When dry, glue the wing tip and tip gusset in place with CA. Note there is no rib at the tip. The tip block will be carved and sanded to the section shown on the plan.

□ □ 21. Using leftover 1/16" balsa sheet, trim four shear webs and install them in the outboard panel as shown. *If you plan to land on the wing tips very often you may want to add shear webs all the way to the tips; but remember, on a 10' airplane, the lighter the tips the better the response.*

□ □ 22. Using thin CA, apply a liberal fillet around each rib on the lower sheeting.

□ □ 23. Remove the outer panel from the worktable and sand the trailing edge joint to the proper angle. Insure the polyhedral brace fits properly at rib "B" and between the spars. Block the wing tip to the height shown on the plan. Using 6-minute epoxy, glue the polyhedral brace to the outer spar. **Do not glue the top spar in position yet.** Glue the trailing edges together with epoxy.

□ □ 24. Trim the last "A" rib to fit at the polyhedral joint. Use 6-minute epoxy to glue the "A" rib and the two plywood gussets in place.

□ □ 25. Trim a piece of 1/16" x 4" x 36" balsa sheet to 24". Save the cutoff piece for use later. Trim this 24" piece to a width of 3-5/8". Glue this inboard top leading edge sheet to the inboard wing panel using aliphatic resin. Use lots of pins and be extremely careful that the sheeting is snug to the rib all the way to the forward edge.

□ □ 26. From the cutoff piece in the previous step, trim the top center wing sheeting to shape and glue into place using aliphatic resin.

□ □ 27. Trim and glue the 1/16" x 1/4" cap strips to the top of the ribs of the inboard panel.

□ □ 28. Unpin the inboard panel from the building board. Block it up, laying the outboard panel flat on the building board and pin it tightly. Fit the top spar in place and trim it even with the bottom spar at the wing tip. Glue the top spar in place using 6-minute epoxy at the polyhedral joint. CA can be used to glue the spar to each rib. Glue the top spar even with the top surface of the wing tip.

□ □ 29. Cut 1/8" from the front of the "A" rib at the polyhedral joint. Fit and glue the 1/8" plywood leading edge brace into place making it flush with the sheeting.

□ □ 30. Trim and splice another 1/16" x 3" x 36" balsa sheet for the top leading edge sheeting as you did in step 4. This sheet should be about **1/16" wider** to allow for the curvature of the ribs. Trim the sheet to length to fit the wing tip block. Use aliphatic resin to glue the sheeting in place making sure the sheeting is snug against the ribs.

□ □ 31. Trim and glue the 1/16" x 1/4" cap strips to the top of the ribs on the outboard panel.

□ □ 32. Remove the wing from the building board. Sand the leading edge of both panels perfectly flat using a two or three foot sanding block. Trim the

7/16" x 1/2" leading edges for a good fit at the polyhedral joint and glue them in place. Hold them firmly in place with masking tape until the glue dries.

□ □ 33. Sand the root of the inboard panel flat and glue the plywood root rib in place.

□ 34. The right wing is built exactly like the left with the exception of the fitting of the fiberglass wing-rod tube. In Step 16, before all the parts have been joined together, fit the left wing panel onto the wing rod and block it for the proper dihedral angle shown on the plan. Align the rod for a good fit at the center of the wing panels. In Step 33, fit the left wing panel onto the wing rod again and make any final adjustments needed for a clean fit prior to gluing the plywood root rib into place.

□ 35. Cut the leading edge template from the plan, glue it to a leftover piece of balsa or 1/8" ply and cut and sand the pattern to shape. Carve and sand the leading edge of each wing panel using the template as a guide. The leading edge tapers from the "E" rib to the tip. The more true the leading edge airfoil, the better the Bird will fly; so take as much time as your patience will allow.

□ 36. Check the fit of the wing rod in the tubes of each panel. Push the rod into one of the panels until it reaches the bevel and won't go in any further. Mark the rod at this point. Remove it and insert the other end into the other wing panel. The rod should go in at least as far as the mark. If it won't, cut a short piece from the rod. If it goes in substantially further than the mark you might want to but spacers into the tubes in each panel. Cut a short piece of 1/4" dowel to the proper length and then cut that piece in half. Push one piece into each tube and check the fit again. Be extremely careful when doing this as it is very hard to remove a piece that is too long.

□ 37. After a thorough sanding your wing is now ready to cover.

NOTE: If you notice a part of a rib hasn't been securely glued to the leading edge sheeting, and if you used aliphatic resin glue, you can use a trim

iron to reseal the glue. Set the iron to it's highest setting and then press the sheeting back into the rib with the iron. When you remove the iron, continue to press the sheeting to the rib with a cloth. The sheeting should now be firmly adhered to the rib.

BUILD THE STABILIZER

1. Use leftover 3/32" balsa to make six 1" squares. Use leftover 1/16" balsa to make six 1/2" squares. These will be used as shims.
2. Cover the stabilizer plan with wax paper.
3. Use CA to glue the die-cut 1/8" balsa trailing edge and tip together.
4. Cut the 3/16" balsa leading edge to length. Glue the 1/8" triangular die-cut brace to the leading edge with CA, centering it top to bottom.
5. Slide the 3/32" shims **under** the wax paper at the trailing edge of each of the four ribs. Let it protrude from under the trailing edge 1/8" or so to support the ribs. Do the same to the leading edge using the 1/16" shims.
6. Pin the leading and trailing edges in place over the plan, supported by the shims. Glue the leading edge to the tip with CA.

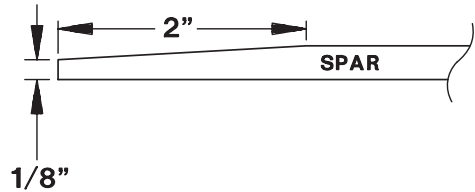

7. Trim the main spar to length from 3/16" **hardwood**. Taper the last 2" at the outboard end, to 1/8" as shown..

NOTE: In the following steps you will be cutting and gluing ribs for the stab from 1/16" x 1/4" balsa sticks. Select material for the opposing top and bottom ribs that have about the same bending strength so the section will turn out symmetrical.

8. Trim the four bottom ribs to length from 1/16" x 1/4" balsa, keeping in mind that they will bow around the main spar. Carry the inboard rib all the way to the leading edge so it will glue to the triangular brace. Pin the spar down over the ribs so that the ribs are snug to the building board. Glue the ribs to the spar, leading edge and trailing edge using CA.
9. Trim short pieces of 1/16" x 1/4" balsa and glue them to the forward end of the ribs against the leading edge. These will support the top ribs.
10. Trim the top ribs to length and glue them in place with CA.
11. Trim and glue the 3/16" sq. root pieces. Tapering of these pieces can be left until later.
12. Remove the stab from the building board and add the 3/16" filler shown in section S-S. Leave about 1/16" of the filler sticking out from the inboard side of the inner rib to form a shelf for the inboard sheeting.

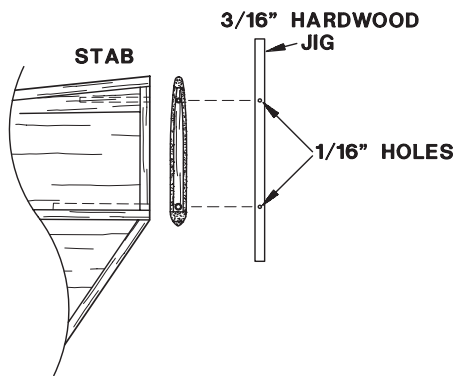

□ □ 13. Use a leftover piece of 3/16" sq. hardwood to make a drill jig for the stab wire holes. Drill two 1/16" holes in the jig using the spacing shown on the plan. The jig will insure the holes are drilled in exactly the same location in each stab half. Using the jig, drill two holes in the stabilizer root ribs. Be careful to drill the holes centered in the rib and parallel to the stab surface.

□ 14. Build the second stabilizer before adding the joiner tubes and wires.

NOTE: In the following steps you will glue in the joiner tubes and wires. We recommend you glue only the wires in one stab and the aluminum bearing tubes in the other. You could, of course, put tubes in both halves and then use the wires to join the two halves. If you do this and forget to bring the wires the day of an important contest, remember that we cautioned you not to do it. If you are going to put tubes in both stab halves anyway, cut a 1/4" long piece off one of the smaller tubes first and set it aside for use later.

□ 15. In one stab half enlarge the aft hole with a 3/32" drill. Roughen the ends of both stab wires with sandpaper and clean them with alcohol. Epoxy the 1/16" wire in the front hole and the 3/32" wire in the rear hole. Be sure the rear wire is exactly along the centerline of the spar.

□ 16. In the other stab half, enlarge the front hole to 3/32" and the rear hole to 1/8". Roughen and clean the mating aluminum bearing tubes. Epoxy the smaller tube in the front hole and the larger tube in

the rear hole. Again, be sure the tube is exactly along the centerline of the spar.

□ 17. Taper the inboard root pieces as shown on the plan with sandpaper. Cut the center stab sheeting from leftover 1/16" wing sheeting and glue it in place. It will rest on the forward triangular brace and stick up about 1/32", but this will be sanded to fair with the leading edge.

□ 18. A careful sanding to the airfoil shown on the plan completes the stabilizer construction.

BUILD THE FIN & RUDDER

□ 1. Cover the fin and rudder plan with wax paper.

□ 2. Cut the fin trailing edge to length from 1/4" x 5/8" hard balsa and pin it to the building board. Laminate the two 1/8" R4 pieces together with thick CA.

□ 3. Fit the fin core R4 to the trailing edge and glue it with CA.

□ 4. Cut and fit the fin leading edge and ribs from 1/4" x 3/8" balsa. Glue them to R4 and the trailing edge with CA. The location of the ribs is not important but the fit is, so move them up or down a little to improve the fit if needed.

□ 5. Use epoxy to glue the 1/4" thick hardwood insert into the cutout in R4. Wipe off any excess epoxy.

□ 6. Prepare a 1/16" fin skin by gluing a die-cut fin side skin and a die-cut dorsal fin skin together with CA. Make sure the bottom edges are properly aligned. Sand the skin smooth using 150-grit sandpaper on an Easy-Touch bar sander with the skin flat on the building board. Prepare a second skin the same way except sand the other side of the skin. The sanded sides will become the outside surfaces of the fin.

❑ 7. Remove the pins from the fin. With the fin flat on the building board, sand it flat. Fit the 1/16" fin skin on the fin, being careful to align it with the trailing edge and bottom of the fin. Glue the fin side to the fin with thick CA or aliphatic resin. When the glue is dry turn the fin over and glue the 1/8" die-cut dorsal fin to the forward part of the fin skin. Align the dorsal fin with the skin along the bottom edge and at the leading edge. Laminate the second 1/8" dorsal fin to the front with thick CA.

❑ 8. Measure and mark the location of the 1/8" hole in the hardwood insert from the plan. Don't worry if it isn't exactly in the center. It is extremely important this hole be square with the insert so we **highly** recommend that you use a drill press to drill the hole. Stabilizers look so much better when they are square to the rest of the airplane and they probably fly better too (I wouldn't know). Carpenters have a saying that is useful at this time - "measure twice, cut once!"

❑ 9. Align the second fin skin with the fin assembly and drill a 1/8" hole in it. This skin will be glued in place at a later time.

❑ 10. Cut the slots for the hinges in the fin trailing edge at the locations shown on the plan. See the enclosed sheet "TIPS FOR USING CA HINGES."

❑ 11. Set the fin aside for now. It will be completed after the fuselage is built.

❑ 12. Cut the rudder leading edge from 3/8" x 1/2" balsa and pin it to the building board.

❑ 13. Build R1 by laminating the three 1/8" balsa die-cut pieces with thick CA. In a similar fashion, build R2 and R3. Pin R1 into position and glue it to the leading edge with CA. Glue R2 and then R3 into position as well.

❑ 14. Cut and fit the ribs from 1/4" x 3/8" balsa. Again, move them up or down slightly as required to get a good fit.

❑ 15. Cut and fit the upper and lower corner gussets from 3/8" x 1/2" balsa. Glue them with CA.

❑ 16. Remove the rudder from the building board and cut a slot for the Ply rudder horn in the lower gusset in the location shown on the plan. Do not glue it in until after the rudder is sanded and covered.

❑ 17. Cut the slots for the hinges in the rudder leading edge at the locations shown on the plan.

❑ 18. **Do not** sand the fin or rudder at this time.

BUILD THE FUSELAGE

❑ 1. Cover the fuselage plan with wax paper.

❑ 2. Bulkhead F1 is built by laminating the three die-cut pieces together with aliphatic resin glue. Before the glue dries lay one edge of the assembly against the building board and make sure they are even and square. F2 and F3 are built in exactly the same way. Set the three assemblies aside until they are dry.

NOTE: You must decide if you want to build the fuselage for the fastest possible speed or for ease of radio installation. If you want speed, trim the bulkheads to the general shape shown by the dotted lines on the plan for F1. You will have some serious tinkering to do to get the receiver, battery pack and servos in a space that narrow.

❑ 3. Remove the fuselage forward and rear sides from the 1/8" balsa die-cut sheet and lightly sand them to remove any irregularities or fuzz. Notice the top and bottom edges of the sides has a slight curve on them. Put both forward sides together and check that they are exactly the same. Lay them flat on the building table, still together, with the bottom edge towards you. Now flip the top piece towards you and lay it flat on the building board with the bottom edges of both sides touching each other. The side closest to you will become the left side.

□ 4. Glue the 1/8" balsa rear fuselage side to the front side with CA on both the left and right sides.

□ 5. Locate the 1/16" balsa die-cut fuselage front and rear doublers and fit them to the sides. The front doubler is longer than shown on the plan and ends at the rear of bulkhead F3. The rear doubler is shorter than shown on the plan. Glue them to the sides using aliphatic resin. After step three it should be impossible to build two left or right sides, but double check to be sure.

□ 6. Place the right fuselage side over the plan (the doubler should be facing up) and mark the location of bulkheads F1, F2 and F3. Transfer the locations to the left fuselage side. Place the 3/8" shaped forward and aft fuselage bottom blocks over the fuselage outline and mark the location of bulkheads F1, F2 and F3.

□ 7. After the bulkheads have dried, sand bulkheads F1, F2 and F3 so that the sides are even and square, but be careful not to over sand. Check their outline with the pieces shown on the plan. Also put the bulkheads at the proper locations on the fuselage bottom and check that the width of the bulkheads matches the width of the bottom.

□ 8. Glue the 1/16" ply doublers to the front and rear sides of bulkheads F1 and F3 as shown on the plan. Drill the 1/4" holes in F1 and F3 and epoxy the 1/4" dowels into the holes as shown. You may want to round the ends of the dowels first. Notch F1, F2 and F3 for the pushrods in the locations shown on the plan. Notch the bulkheads for an antenna tube as well.

Note: most contest flyers are occasionally forced to make those point-getting spear landings. One problem with the type of wing hold down system used on the Bird is that sometimes during the spear, the wing slides forward and forces the rubber bands off the dowel. The wing flies off and – zowie, no landing points. This can be prevented by drilling a vertical 1/16" hole about 1/8" from the end of the dowel in F1. You can then put a 1/16" piano wire pin in the hole, preventing the rubber bands from sliding off.

□ 9. If you will be installing an optional tow hook release mechanism you will need to cut the rear of the 3/8" forward bottom block to fit. Note the forward and aft blocks join together in the middle of bulkhead F2. After fitting the tow hook release skip to step 11.

□ 10. Find the two 1/16" ply forward bottom block doublers. The wider of the doublers will be fitted to the side that faces the inside of the fuselage. Put the doubler on the forward bottom block and align it with the rear edge as shown on the plan. Trace around the doubler and then use your knife to remove 1/16" of wood from the balsa block so that the doubler can be inlaid into the block. Be careful not to cut too deeply into the block. The doubler is sized to fit about 1/8" from the sides of the block so you won't hit it when sanding the sides to shape. Fit the other doubler to the other side of the forward bottom block. Epoxy both doublers into place.

□ 11. Carefully align the forward and aft bottom blocks over the fuselage outline on the plan and pin them securely in place. Glue the joint where they meet with CA. Using the centerline drawn on the plan as a reference, draw a centerline down the bottom blocks. At the locations marked earlier for the bulkheads draw reference lines that are perpendicular to the centerline. Glue bulkheads F1, F2 and F3 in position using CA. Be sure the bulkheads are aligned with the sides and vertical to the bottom. Try to build the fuselage fairly straight; I rarely do so myself, but that's no excuse for you to be sloppy.

□ 12. Position the right fuselage side over the outline. The front end is located 7/16" aft of the front of the forward bottom block. The top of the right side should be flush with the top of the three bulkheads. When satisfied with the alignment, tack glue the side to bulkheads F1 and F3 with thin CA. Align the left side and tack glue it in the same way.

□ 13. Remove the fuselage from the building board. You must now glue the bottom block to the fuselage sides along their entire length, which as you can see, is curved. This is easily accomplished by

gluing one small section at a time. Hold the fuselage in one hand and bend the bottom block until a section is aligned with the side, then squeeze the sides together. From the inside of the fuselage tack glue this spot to the sides with thin CA. Proceed down the length of the fuselage until it is tacked along the entire length, fore and aft. Now wick thin CA into all the joints where the bulkheads and bottom block meet the sides. As you do so, firmly squeeze the sides together to assure a tight joint.

TIP: It is best to put some wax paper on the outside of the fuselage when you do this as it is surprisingly easy to glue your fingers to the sides. Also, make sure you are in a well ventilated area as you will likely create a small cloud of vapors.

□ 14. Glue the nose block to the front of the fuselage with epoxy. The block rests on the front edge of the bottom block and the front of the sides. Epoxy the top front block to the top of the fuselage sides. This block is glued to the front of the sides, **not** between them as the bottom block is.

□ 15. Do not glue the top rear block on until the fin and control linkages are fitted.

FINAL ASSEMBLY

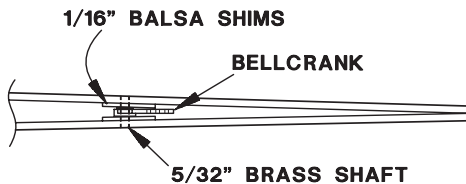

□ 1. Carefully mark the location of the hole for the bellcrank pivot shaft on the side of the fuselage. Drill

this hole with a 5/32" drill at a right angle with the fuselage centerline. Prepare two 1/2" x 1/2" shims from leftover 1/16" balsa and glue them on the inside of each fuselage side over the 5/32" hole with CA. Drill through the holes again with the 5/32" drill. Insert the shaft in one fuselage side, through the bellcrank and then into the other side. Check that the bellcrank moves freely on the shaft, and then glue the shaft in place with 6-minute epoxy. This is best done by putting the glue into the hole from the outside of the fuselage sides. It is OK to get glue on the inside of the shaft, but not on the outside. Do not let any glue get into the bellcrank area. After the glue cures check that the bellcrank still moves freely. If the bellcrank should touch the fuselage bottom block cut a small area out to clear the bellcrank.

□ 2. Thread the nylon swivel clevis half-way onto the 2-56 x 1" threaded rod. Screw the steel clevis onto the other end until they are both touching. The distance between the pin of the steel clevis and the hole in the swivel clevis should be just under 1-3/4". Install the metal clevis onto the last hole of the bellcrank.

□ 3. Locate one of the wire pushrods and make a Z-bend in one end. Insert the wire into a plastic tube and then insert the Z-bend into the last hole on the other end of the bellcrank. Insert the pushrod and tube into the notches you cut in the fuselage bulkheads on the left fuselage side. This will require considerable flexing of the pushrod.

□ 4. Drill a 1/8" hole in the left fuselage side for the rudder pushrod. This hole should be located at the top of the bottom fuselage block and should exit at about the location of the lower bellcrank arm. Install the plastic tube and make sure it does not interfere with the bellcrank. Glue both pushrods to the bulkheads and to the fuselage sides every three inches. Trim the tube flush with the outside of the fuselage.

- ❑ 5. Install the antenna tube (not included) if you are using one. I believe this quote is from Dave Thornburg: "If I catch you running your antenna out from under the wing and straight back to the tip of the rudder or stab, I will personally jump up and down on your Bird of Time until it is no more. Antennae go **inside** fuselages, out of the slipstream."
- ❑ 6. If you are known for your spear landings, then you may want to glue the 1/8" ply stiffener in the rear of the fuselage as shown on the plan. Otherwise don't, as every ounce in the tail requires 2-1/2 ounces in the nose to balance it.
- ❑ 7. Before gluing the top rear fuselage block in place you should cut the notch for the elastic bands in the front of the block. The plan shows a suggested outline. Glue the top rear fuselage block to the fuselage sides with CA, using the same "squeeze" technique as you did with the bottom blocks.
- ❑ 8. Fit the fin into position, trimming as necessary, and glue it to the fuselage using aliphatic resin glue. Be sure it is square with the fuselage and aligned with the fuselage centerline. Check that the dorsal fin is even with the top of the fuselage. Check that the elevator linkage is in it's cutout area and that the bellcrank still moves freely. Pin the fin in position until the glue dries.
- ❑ 9. Insert the 3/32" I.D. brass tube stab pivot shaft into the hole in the fin hardwood block so that about 3/16" sticks out from the side with the 1/16" skin on it. Partially install the stab half with the wires in position by inserting the large wire in the pivot shaft and the small wire into the hole in the nylon swivel clevis. Use the elevator pushrod to move the linkage up and down, marking the location of the slot to be cut in the fin skin. After cutting the slot, push the stab fully into position and move the linkage throughout it's full range to check the clearance of the forward wire in the slot. Remove the stab, place the other fin skin in position against the fin and mark and cut the other slot.
- ❑ 10. Cut a 1/4" long piece of the small aluminum tube and clean out any burrs. Install this piece in the holes at the end of the swivel clevis. Install both stab halves on the fin and make a final check of the elevator linkage. You should have a total throw of at least 1/2". Also check the stab is perfectly square with the fin. If it isn't, move and twist the fin and pivot shaft as needed. When satisfied with the fit, glue the pivot tube in position by putting a drop of CA on each end where it meets the fin. Be very careful not to get any glue in the tube itself or on the wire, unless you don't mind the stab being permanently glued to the fin!
- ❑ 11. Remove the stab and glue the second fin skin to the fin with aliphatic resin glue. Pin it into position and then check that the elevator linkage does not bind on the skin. Make any needed adjustments before the glue sets.
- ❑ 12. Add a few more drops of CA to the stab pivot shaft to insure it is solidly glued into the fin. Grind the ends of the shaft with a Dremel® tool or file so each side sticks out about 1/16". Drill out the tube with a 3/32" drill to remove any burrs or glue from inside the shaft.
- ❑ 13. Trim the front and rear of the nose hatch cover to shape. It should be the only piece of wood left in the box. If it isn't, now is a good time to find out why! Drill a 1/8" hole into the front end of the hatch where shown and glue the 1/8" dowel into the hole. Align and drill the mating 1/8" hole in the upper nose block. Tack glue the hatch in position with CA.
- ❑ 14. Use a razor plane and knife to carve and sand the fuselage to the contours shown on the plan. Sand the rudder and fin to the contours shown. Fill in around the dorsal fin so that it blends smoothly with the fuselage.
- ❑ 15. After a final sanding, remove the hatch and decide how you will hold it down. We used "J" hooks and a rubber band. If you are a spear landing artist it is advisable to cover the nose of the aircraft with fiberglass back to bulkhead F1.

FINISHING

1. We recommend you use Top Flite® MonoKote® film to cover the wings and tail as it adds a great deal of strength and rigidity to these parts. The fuselage will be far more interesting. If you regard applying MonoKote film to compound curves as an interesting challenge, you will have a ball. Those who have tried say it's easier than applying MonoKote film to a golf ball, though not much. EconoKote is much more flexible and would be easier. Top Flite LustreKote™ paint would be a good choice as well.
2. When done, add the tailskid and nose skid, if you use one.
3. Install the Ply rudder horn as shown on the plan. Make a Z-bend on one end of the wire pushrod and install it onto the horn.
4. Place the radio components about where you think they should go, assemble the wings and stab and do a preliminary balance check. We recommend you balance the Bird on the spar, shifting the radio components or adding lead as required. More on this in a moment.
5. Mount the servos and hook up the pushrods to them. Mount the receiver and battery with foam rubber.

TIME TO FLY

The entire airplane should weigh about 41 ounces. Hand glide the Bird to see that the elevator setting is in the ball park. During test flying, test the Bird for the proper C.G. location, anywhere from the spar to 1/4" aft. You'll find the plane will fly at a wide range of elevator throws and C.G. locations, but will only **perform** at one. To find that setting, you will need cool morning air that is preferably dead calm. When you find it, the plane will speed up just a little and "go on step", and the L/D will appear to double. It will

probably be way off on the down end of the elevator spectrum. When you find the setting be sure to mark it on the side of the fin so you can get it back again. Bear in mind that C.G. changes and changes in air-density will have a small affect.

We recommend you make two pine blocks that fit exactly into the open areas in front of and behind bulkhead F2. Drill them out and epoxy in lead or BB's until you bring the total weight of the Bird up to 52 oz., without changing the C.G. of the airplane. Mark these blocks "7 oz./ft." and set them aside. Make a second set that brings the total weight up to 70 oz., and mark them 9.5 oz./ft. These will be needed for use at speed events.

Don't forget to add your AMA I.D. sticker and take lots of pictures.

Good flying!



Issued by the
ACADEMY OF MODEL AERONAUTICS

This is an experimental model which may be lost in flight. The fuel tank may contain gasoline or other flammable fluid, which should be drained before transporting or storing. Keep away from fire.

Finder should notify owner immediately. Model should not be given to any claimant unless positive identification is provided.

License No.....

Name

Address

City.....State

Phone.....

**UNAUTHORIZED POSSESSION OF THIS MODEL CAN
LEAD TO PROSECUTION UNDER LAW.**



Cut and glue this identification tag inside of your model.